

HANDBOOK



PEUGEOT 208





## Flipbook



The handbook.

The on-line handbook:

<http://public.servicebox.peugeot.com/ddb/>



Find all of the information from the handbook for your vehicle on the internet.

The latest information included is identified by this symbol:



From the home page presenting the range, choose a language, click on the body style and then the edition, by reference to the date of first registration of the vehicle.

## Start MyPEUGEOT



To download to your smartphone.



The Start MyPEUGEOT application is available for your vehicle and allows familiarisation with your new PEUGEOT.

Summary of the main systems and their settings.

Access to certain driving assistance systems.

Library of warning and indicator lamps.

Focus on audio & telematic functions.

## Start MyPEUGEOT

### Mirror Screen

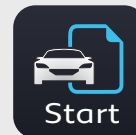

To display in the touch screen of your vehicle.



App Store for smartphones that support CarPlay® and Google Play for smartphones that support MirrorLink™.

The synchronisation of a personal smartphone allows users to display applications from the smartphone adapted for the CarPlay® and MirrorLink™ technology.

The Start MyPEUGEOT inter-activity becomes available in landscape format in the touch screen.



## Welcome

Thank you for choosing a 208.

This handbook has been designed to help you make the most of your vehicle in all circumstances.



PEUGEOT

**Overview**

Exterior view	4
Interior view	5
Instruments and controls	6
Middle console	8
Upper console	9
Lower console	9
Underbonnet view	10

**Instruments**

Instrument panels	11
Library of indicator and warning lamps	14
Engine coolant temperature	25
Touch screen	29
Trip computer	30
Date and time	33
Lighting dimmer	34

**Access**

Unlocking - Key	35
Doors	35
3-door	36
Locking - Key	37
Alarm	41
Boot	43
Window controls	46

**Ease of use and comfort**

PEUGEOT i-Cockpit	48
Front seats	49
One-piece rear seats	53
Ventilation	56
Heating	59
Air conditioning	61
Dual-zone digital air conditioning	63
Demisting - defrosting	66
Courtesy lamp	68
Mood lighting	69
Sunroof blind	70
Interior fittings	71
Ports and sockets - Connectivity	72
Boot fittings	73
Rear parcel shelf	74

**Lighting and visibility**

Mirrors	75
Lighting	77
Automatic illumination of headlamps	79
Daytime running lamps	83
Direction indicators	84
Headlamp adjustment	85
Cornering lighting	86
Wipers	87

**Safety**

Hazard warning lamps	90
Road holding	90
Seat belts	93
Airbags	96
Carrying children	100
Deactivating the passenger's front airbag	102
ISOFIX child seats	109
Child lock	114

**Driving**

Eco-driving	115
Driving recommendations	117
Starting	118
Switching off	120
Parking brake	121
Manual gearbox	122
Electronic gearbox	123
Automatic gearbox	126
Gear shift indicator	129
Hill start assist	130
Stop & Start	131
Speed limiter	134
Cruise control	136
Active City Brake	141
Parking sensors	144
Reversing camera	146
Park Assist	147
Under-inflation detection	151

	Practical information	<b>7</b>
Fuel tank		154
Snow chains		158
Towing a trailer		159
Energy load		161
Accessories		162
Changing a wiper blade		164
Fitting roof bars		165
Bonnet		167
Checking levels		170
Checks		173
BlueHDi and AdBlue® additive		174
Straight cut matt paint		181

	In the event of a breakdown	<b>8</b>
Triangle		182
Temporary puncture repair kit		183
Spare wheel		188
Changing a bulb		195
Fuses		202
12 V battery		208
Towing		212
Running out of fuel (Diesel)		214

	Technical data	<b>9</b>
General information		215
Petrol engines		216
Diesel engines		217
Dimensions (in mm)		218
Identification markings		220

	Audio equipment and telematics	<b>10</b>
Emergency call		222
Assistance call		223
7-inch touch screen		225
Audio system / Bluetooth		295
Audio system		315

	Alphabetical index	
---	--------------------	--

## Key

 **Warning**  
This symbol marks warnings which it is essential to observe for your own safety, for the safety of others or to avoid any risk of damaging your vehicle.

 **Information**  
This symbol draws your attention to additional information for better use of your vehicle.

 **Protection of the environment**  
This symbol accompanies advice relating to protection of the environment.

 **Advice**  
This symbol indicates a reminder of practical information.

# Exterior view

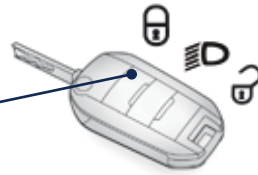

Remote control key	35-39, 44
- opening / closing	
- anti-theft protection	
- guide-me-home lighting	
- starting	
- switching off	
- battery	
- unlocking the vehicle	
- locking the vehicle	

Lighting controls	77-83
LED lamps	83
Daytime running lamps	83
Headlamp beam adjustment	85
Cornering lighting	86
Changing bulbs	195-199
- front lamps	
- foglamps	
- direction indicator repeaters	

Door mirrors	75-76
--------------	-------

Doors	35-39, 40
- opening / closing	
- central locking	
- emergency control	
Courtesy lamp	68
Alarm	41-42
Electric windows	46-47

Sunroof blind	70
Roof bars	165
Accessories	162-163
Advice on care	181

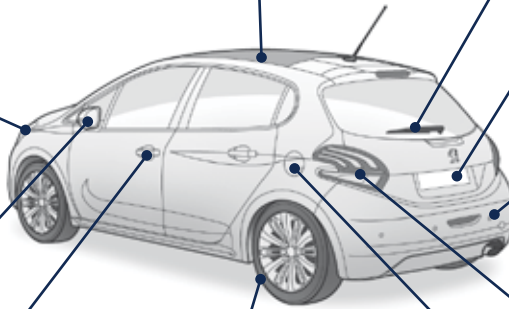

Roadholding	90-92
Snow chains	158
Under-inflation	151-153
Tyre pressures	186-187, 220
Spare wheel	188-194
- tools	
- removing / refitting	

Wipers	87-89
Changing a wiper blade	164
Demisting - Defrosting	66-67

Boot	43
- opening / closing	
- emergency release	
Reversing camera	146
Temporary puncture repair kit	183-187

Park Assist	147-150
Parking sensors	144-145
Towbar	159-161
Towing	212-213

Changing bulbs	199-201
- rear lamps	
- 3 <sup>rd</sup> brake lamp	
- number plate lamps	
- foglamp	

Fuel tank, misfuel prevention	154-157
Running out of Diesel fuel	214

# Interior view

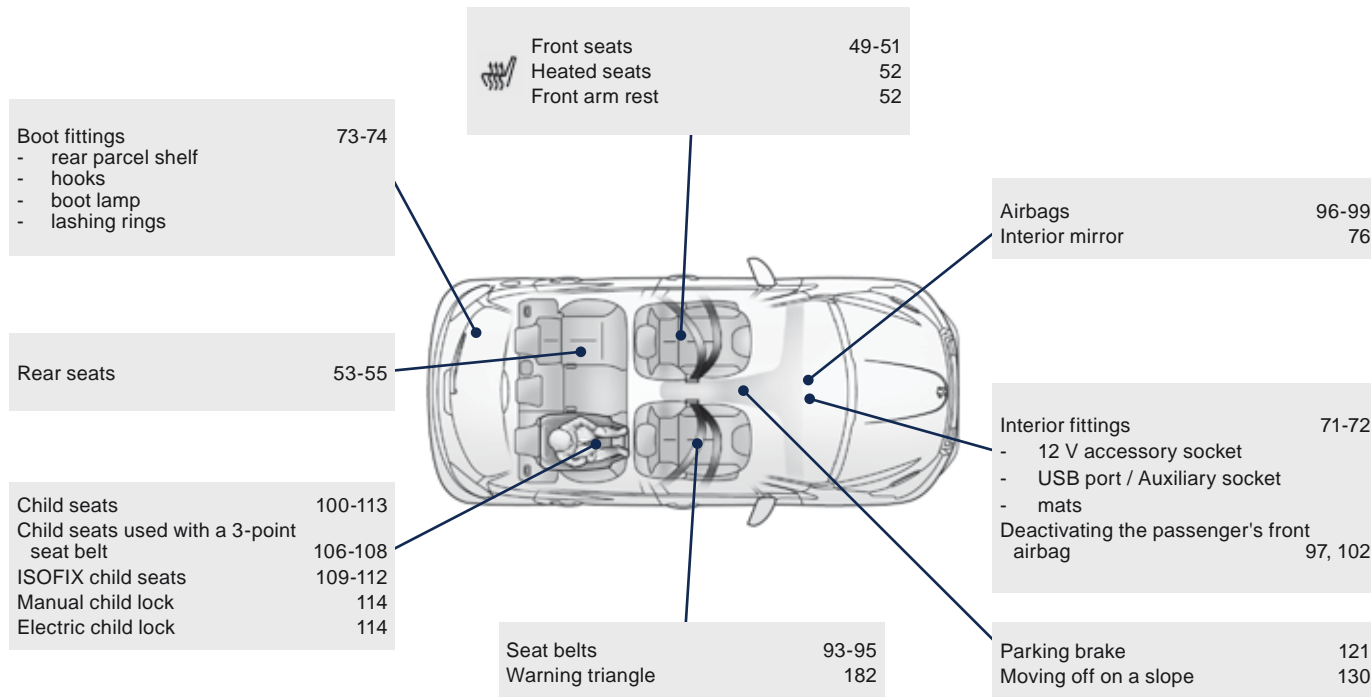

# Instruments and controls

## On the left

Lighting. 77-80

Main or dipped beam headlamps.

Front and rear foglamps.

Direction indicators.

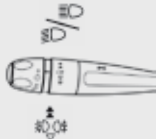

84

Steering mounted controls for the touch screen: volume, change source.



228

Cruise control. 136-138

Speed limiter. 134-135

Memorise speeds. 139-140



"-" Change down (if electronic gearbox).



123-124

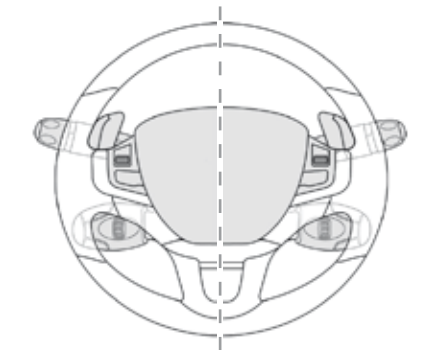
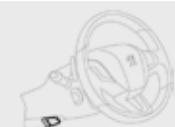



Adjust the steering wheel. 48



Front airbag. 96-97

## On the right



Screen wash/wipe. 87-89

Trip computer. 30

Intermittent rear wipe. 88



Steering mounted controls for the touch screen. 228



Steering mounted controls for the audio system. 297, 317



"+" Change up (if electronic gearbox). 123-124



## Side switch panel\*

Activate Park Assist.

147-150



Reinitialise the under-inflation detection (without touch screen).

151-153

or

Deactivate the rear parking sensors.

144-145



Deactivate volumetric alarm monitoring.

41-42

Deactivate the DSC/ASR system.

90-92



Activate the electric child lock.

114

Deactivate Stop & Start.

131-133



Adjust the headlamp beam height.

85



A lamp indicates the state of the function.





\* Depending on version.

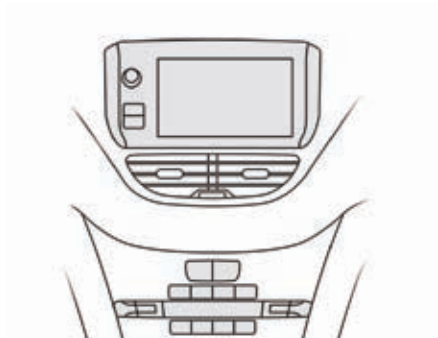





# Centre console



## Middle console

- 
Touch screen.  
225-293
- 
Bluetooth audio system.  
295-313
- 
Audio system.  
315-326
- 
Hazard warning lamps.  
90

- 
Central locking.  
40
- 
Heating / Ventilation.  
59-60
- 
Manual air conditioning.  
61-62
- 
Demisting / Defrosting  
(rear screen, mirrors,  
windscreen, side  
windows).  
66-67
- 
Dual-zone automatic  
air conditioning.  
63-65

## Upper console



PEUGEOT Connect Assistance.  
223

SOS

PEUGEOT Connect SOS.  
222



Courtesy lamp switches.  
68

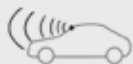

Active City Brake.  
141-143

## Lower console

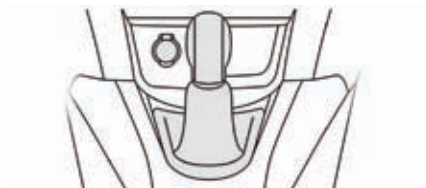

12 V socket.  
72



USB port / Jack auxiliary socket.  
72

## Gearbox



Manual 5.  
122



Manual 6.  
122



Electronic 5.  
123-125



Electronic 6.  
123-125



Automatic 4 / Automatic 6.  
126-128

# Underbonnet view

AdBlue® additive	174-180
Checking levels	89, 168-172, 178-179
- oil	
- brake fluid	
- coolant	
- screenwash fluid	
- additive (HDi Diesel AdBlue®)	
Checks and maintenance	168-169, 173
- air filter	
- oil, oil filter	
- particle filter (Diesel)	
- brake fluid	
- brake pads / discs	

Changing bulbs	195-201
- front	
- rear	

Running out of fuel, Diesel	214
-----------------------------	-----

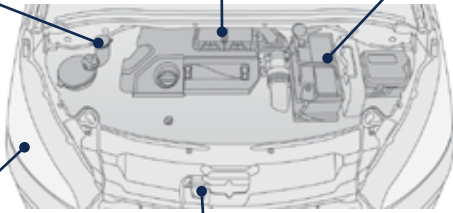

Opening the bonnet	167
Under the bonnet, petrol	168
Under the bonnet, Diesel	169
Petrol engines	215-216
Diesel engines	215, 217

12V battery	208-211
Load reduction, economy mode	161
Engine compartment fuses	202-203, 207
Dashboard fuses	202-206

Petrol weights	215-216
Diesel weights	215, 217

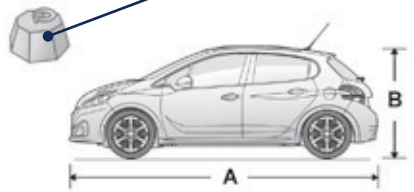

Identification markings	220
Dimensions	218-219

# Instrument panels



## Rev counter

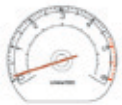

Rev counter (x 1000 rpm), graduation depends on the engine (petrol or Diesel).

## Control button



Recall the servicing information.

Adjust the time.

Reset the function selected (service indicator or trip recorder).

Depending on version:

- Adjust the time.
- Digital speedometer.

## Speedometer



Analogue speedometer (km/h or mph).



## Indicator



Engine coolant temperature indicator.

## Instrument panel lighting



Main lighting dimmer.



Instrument panel ambience lighting.

## Fuel gauge



Fuel level in the tank.

## Display screens

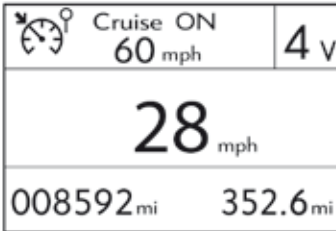

Cruise control settings.



Speed limiter settings.



Service indicator.

13855<sub>kmi</sub>

Odometer (km or miles).

570.6<sub>km/h</sub>

Trip recorder (km or miles).

OIL

Engine oil level indicator (depending on version).

'4

Gear shift indicator with a manual gearbox.

D S+4  
AUTO

Selector position and gear with an electronic gearbox.  
Selector position and gear with an automatic gearbox.

28<sub>km/h</sub>

Digital speedometer (km/h or mph).

1/000

This function can be deactivated by a long press on this button (depending on version).

## Trip computer

 Stop & Start time counter.

 Remaining driving range.

 Current or average fuel consumption.

 Average speed of the vehicle.

 Distance travelled by the vehicle.

## Gearbox

**P** Park position.

**R** Reverse.

**N** Neutral.

**A**  
**D** Automatic mode.

**M** Manual mode.

**+**  
**-** Change up / Change down.

**S** Sport programme.

 Snow programme.

## Library of indicator and warning lamps

### Indicator and warning lamps

- indicator lamp informing that a system is switched on,
- warning lamp for preventive purposes or for a fault.

### When the ignition is switched on

Certain warning lamps come on for a few seconds in the instrument panel and/or instrument panel screen when the vehicle's ignition is switched on.

When the engine is started, these same warning lamps should go off.

If they remain on, before moving off, refer to the information in the table on the warning lamp concerned.



### Associated warnings





The illumination of certain warning lamps may be accompanied by an audible signal and a message in the instrument panel or multifunction screen.



The warning lamps may come on continuously (fixed) or flash.





Certain warning lamps may come on in one of two modes. Only by relating the type of lighting to the operating status of the vehicle can it be ascertained whether the situation is normal or whether a fault has occurred.









Warning / indicator lamp	State	Cause	Action / Observations
	<b>Parking brake</b>	fixed.	The parking brake is applied or not properly released.  Release the parking brake to switch off the warning lamp, keeping your foot on the brake pedal. Observe the safety recommendations. For more information on the parking brake, refer to the corresponding section.
	<b>Foot on the brake pedal</b>	fixed.	The brake pedal must be pressed.  With an electronic gearbox, press the brake pedal to start the engine (lever in position <b>N</b> ). With an automatic gearbox, with the engine running, press the brake pedal before releasing the parking brake, to unlock the lever and come out of position <b>P</b> . If you wish to release the parking brake without pressing the brake pedal, this warning lamp will remain on.
		flashing.	With an electronic gearbox, if you hold the vehicle on an incline using the accelerator for too long, the clutch overheats.  Use the brake pedal and/or the parking brake.
	<b>Diesel engine pre-heating</b>	fixed.	The key is at position 2 (ignition on) in the ignition switch.  Wait until the warning lamp goes off before starting. The period of illumination of the warning lamp is determined by the ambient conditions (up to about 30 seconds in very low temperatures). If the engine does not start, switch the ignition off and then on, wait until the warning lamp goes off again, then start the engine.

Warning / indicator lamp		State	Cause	Action / Observations
	<b>Foot on the clutch</b>	fixed.	In the STOP mode of Stop & Start, changing to START mode is refused because the clutch pedal is not fully down.	You must declutch fully to allow the change to engine START mode.
	<b>Stop &amp; Start</b>	fixed.	When the vehicle stops (red lights, traffic jams, ...) the Stop & Start system has put the engine into STOP mode.	The warning lamp goes off and the engine restarts automatically in START mode, as soon as you want to move off.
		flashes for a few seconds, then goes off.	STOP mode is temporarily unavailable. Or START mode is invoked automatically.	For more information on Stop & Start, refer to the corresponding section.
	<b>Automatic wiping</b>	fixed.	The wiper control is pushed downwards.	Automatic front wiping is activated. To deactivate automatic wiping, operate the control stalk downwards or put the stalk into another position.
	<b>Passenger's airbag system</b>	fixed.	The control, located in the glove box, is set to the <b>OFF</b> position. The passenger's front airbag is deactivated. You can install a rearward facing child seat, unless there is a fault with the operation of the airbags (Airbag warning lamp on).	Set the control to the <b>ON</b> position to activate the passenger's front airbag. In this case, do not fit a child seat in the rearward facing position.



Warning / indicator lamp		State	Cause	Action / Observations
	<b>STOP</b>	fixed, associated with another warning lamp.	It is associated with the engine oil pressure or the engine coolant temperature.	Stop as soon as it is safe to do so. Park, switch off the ignition and call a PEUGEOT dealer or qualified workshop.
	<b>Service</b>	fixed, associated with another warning lamp.	Major faults have occurred.	Refer to the section on this warning lamp and you must then contact a PEUGEOT dealer or qualified workshop.
		fixed associated with a message (if a display screen is fitted).	Faults have occurred for which there is no specific warning lamp.	Identify the fault by reading the message shown in the screen (if a display screen is fitted) and refer to the corresponding section: <ul style="list-style-type: none"> <li>- engine oil level alert,</li> <li>- risk of blockage of the particle filter (Diesel),</li> <li>- Diesel fuel additive level (Diesel with particle filter).</li> </ul> You must contact a PEUGEOT dealer or a qualified workshop.







Warning / indicator lamp	State	Cause	Action / Observations
	<b>Braking</b> fixed.	The brake fluid level has dropped significantly.	You must stop as soon as it is safe to do so. Top up with brake fluid listed by PEUGEOT. If the problem persists, have the system checked by a PEUGEOT dealer or a qualified workshop.
 + 	fixed, associated with the ABS warning lamp.	The electronic brake force distribution (EBFD) system has a fault.	You must stop as soon as it is safe to do so. Have it checked by a PEUGEOT dealer or a qualified workshop.
	<b>Maximum coolant temperature</b> fixed with the needle in the red zone.	The temperature of the cooling system is too high.	Stop as soon as it is safe to do so. Wait until the engine has cooled down before topping up the level, if necessary. If the problem persists, contact a PEUGEOT dealer or a qualified workshop.
	<b>Anti-lock Braking System (ABS)</b> fixed.	The anti-lock braking system has a fault.	The vehicle retains conventional braking. Drive carefully at reduced speed and contact a PEUGEOT dealer or a qualified workshop without delay.

Warning / indicator lamp		State	Cause	Action / Observations
	<b>Dynamic stability control (DSC/ASR)</b>	flashing.	The DSC/ASR regulation is operating.	The system optimises traction and improves the directional stability of the vehicle in the event of loss of grip or trajectory.
		fixed.	The DSC/ASR system has a fault.	Have it checked by a PEUGEOT dealer or a qualified workshop.
	<b>Power steering</b>	fixed.	The power steering has a fault.	Drive carefully at reduced speed. Have it checked by a PEUGEOT dealer or a qualified workshop.
	<b>Engine autodiagnosis system</b>	fixed.	The emission control system has a fault.	The warning lamp should go off when the engine is started. If it does not go off, contact a PEUGEOT dealer or qualified workshop without delay.
		flashing.	The engine management system has a fault.	Risk of destruction of the catalytic converter. Have it checked by a PEUGEOT dealer or a qualified workshop.
		fixed, associated with the SERVICE warning lamp.	A minor engine fault has been detected.	Have it checked by a PEUGEOT dealer or a qualified workshop.
		fixed, associated with the STOP warning lamp.	A major engine fault has been detected.	You must stop as soon as it is safe to do so. Park, switch off the ignition and contact a PEUGEOT dealer or a qualified workshop.
				
				

Warning or indicator lamp in the instrument panel		State	Cause	Action / Observations
 <b>AdBlue® additive (BlueHDi Diesel)</b>	fixed, on switching on the ignition, accompanied by an audible signal and a message indicating the remaining driving range.	The remaining driving range is between 350 miles (600 km) and 1500 miles (2400 km).	Have the AdBlue® additive tank topped up as soon as possible: go to a PEUGEOT dealer or a qualified workshop, or carry out this operation yourself.	
	flashing, accompanied by an audible signal and a message indicating the remaining driving range.	The remaining driving range is between 0 and 350 miles (600 km).	You must <b>top-up the AdBlue®</b> additive tank to <b>avoid a breakdown</b> : go to a PEUGEOT dealer or a qualified workshop, or carry out this operation yourself.	
	flashing, accompanied by an audible signal and a message indicating that starting is prevented.	The AdBlue® tank is empty: the starting inhibition system required by legislation prevents starting of the engine.	To be able to start the engine, you must <b>top-up the AdBlue®</b> additive tank: go to a PEUGEOT dealer or a qualified workshop, or carry out this operation yourself. It is <b>essential</b> to add at least 3.8 litres of AdBlue® to the additive tank.	



**i** For topping-up or for more information on the AdBlue® additive, refer to the corresponding section.







Warning or indicator lamp in the instrument panel	State	Cause	Action / Observations
 <p>SCR emissions control system (BlueHDi Diesel)</p> <p>+</p>  <p>+</p> 	<p>fixed, on switching on the ignition, associated with the SERVICE and engine diagnostic warning lamps, accompanied by an audible signal and a message.</p>	<p>A fault with the SCR emissions control system has been detected.</p>	<p>This alert disappears once the exhaust emissions return to normal levels.</p>
	<p>flashing, on switching on the ignition, associated with the SERVICE and engine diagnostic warning lamps, accompanied by an audible signal and a message indicating the remaining driving range.</p>	<p>After confirmation of the fault with the emissions control system, you can drive for up to 650 miles (1 100 km) before the engine starting inhibition system is triggered.</p>	<p>Contact a PEUGEOT dealer or a qualified workshop <b>without delay, to avoid a breakdown.</b></p>
	<p>flashing, on switching on the ignition, associated with the SERVICE and engine diagnostic warning lamps, accompanied by an audible signal and a message.</p>	<p>You have exceeded the authorised driving limit following confirmation of a fault with the emissions control system: the engine starting inhibition system prevents starting of the engine.</p>	<p>To be able to start the engine, you <b>must</b> call on a PEUGEOT dealer or a qualified workshop.</p>

Warning / indicator lamp		State	Cause	Action / Observations
	<b>Low fuel level</b>	fixed with the needle in the red zone.	There remains approximately <b>5 litres</b> of fuel in the tank. At this point, you begin to use the fuel reserve.	Refuel as soon as possible to avoid running out of fuel. This warning lamp will come on every time the ignition is switched on, until a sufficient addition of fuel is made. Fuel tank capacity: approximately <b>50 litres</b> . Never continue to drive until you run out of fuel, as this could damage the emission control and injection systems.
		flashing with the needle in the red zone.	There remains very little fuel in the tank.	
	<b>Engine oil pressure</b>	fixed.	There is a fault with the engine lubrication system.	You must stop as soon it is safe to do so. Park, switch off the ignition and contact a PEUGEOT dealer or a qualified workshop.
	<b>Battery charge*</b>	fixed.	The battery charging circuit has a fault (dirty or loose terminals, slack or cut alternator belt, ...).	The warning lamp should go off when the engine is started. If it does not go off, contact a PEUGEOT dealer or a qualified workshop.
  + 	<b>Under-inflation</b>	fixed.	The pressure in one or more wheels is too low.	Check the pressure of the tyres as soon as possible. This check should preferably be carried out when the tyres are cold.
		flashing then fixed, accompanied by the Service warning lamp.	The tyre pressure monitoring system has a fault or no sensor is detected on one of the wheels.	Under-inflation detection is not assured. Have the system checked by a PEUGEOT dealer or a qualified workshop.

\* Depending on the country of sale.



Warning / indicator lamp	State	Cause	Action / Observations	
	<b>Door(s) open</b>	fixed, associated with a message identifying the door, if the speed is below 6 mph (10 km/h).	Close the door or boot.	
		fixed, associated with a message identifying the door, together with an audible signal if the speed is above 6 mph (10 km/h).		
	<b>Seat belt(s) not fastened / unfastened</b>	fixed then flashing accompanied by an increasing audible signal.	A seat belt has not been fastened or has been unfastened.	Pull the strap then insert the tongue in the buckle.
	<b>Airbags</b>	on temporarily.	This lamp comes on for a few seconds when you turn on the ignition, then goes off.	This lamp should go off when the engine is started. If it does not go off, contact a PEUGEOT dealer or a qualified workshop.
		fixed.	One of the airbag or seat belt pretensioner systems has a fault.	Have them checked by a PEUGEOT dealer or a qualified workshop.

Warning / indicator lamp		State	Cause	Action / Observations
	<b>Left-hand direction indicator</b>	Flashing with audible signal.	The lighting stalk has been pushed down.	When changing lane.
	<b>Right-hand direction indicator</b>	Flashing with audible signal.	The lighting stalk has been pushed up.	
	<b>Sidelamps</b>	fixed.	The lighting control stalk is in the "Sidelamps" position.	On manual operation of the lighting or in automatic mode.
	<b>Dipped beam headlamps</b>	fixed.	The lighting control stalk is at the "Dipped beam" position.	
	<b>Main beam headlamps</b>	fixed.	The lighting control stalk has been pulled toward you.	Pull the control stalk again to return to dipped beam.
	<b>Front foglamps</b>	fixed.	The front foglamps are switched on using the ring on the lighting control stalk.	Turn the ring on the lighting control stalk rearward once to switch off the front foglamps.
	<b>Rear foglamp</b>	fixed.	The rear foglamp has been switched on using the ring on the lighting control stalk.	Turn the ring on the lighting control stalk to the rear to switch off the rear foglamp.

# Engine coolant temperature

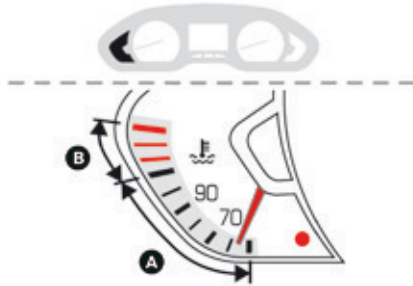

With the engine running, when the needle is:

- in zone **A**, the temperature of the engine coolant is correct,
- in zone **B**, the temperature of the engine coolant is too high; the maximum temperature and the central **STOP** warning lamps come on, accompanied by an audible signal and a warning message in the screen.

**You MUST stop as soon as it is safe to do so.**

Wait a few minutes before switching off the engine.

Contact a PEUGEOT dealer or a qualified workshop.

## Checking the level

After driving for a few minutes, the temperature and pressure in the cooling system increase.

To top up the level:

- ☞ wait at least one hour for the engine to cool,
- ☞ unscrew the cap two turns to allow the pressure to drop,
- ☞ when the pressure has dropped, remove the cap,
- ☞ top up the level to the "MAX" mark.

**!** Be aware of the risk of burns when topping up the cooling system. Do not fill above the maximum level (indicated on the header tank).

## Level



The coolant level should be close to the "MAX" mark but should never exceed it.

When the engine is warm, the temperature of the coolant is regulated by the fan.

**!** The cooling fan may start after switching off the engine: take care with articles and clothing that might be caught by the fan blades.

## Changing the coolant

The coolant does not have to be replaced at routine services.

## Fluid specification

The coolant must conform to the manufacturer's recommendations.

# Servicing



This is a countdown between the intervals given in the manufacturer's service schedule.



It is calculated from the last reset of the service indicator, according to the mileage covered and the time elapsed since the last service.

**i** For BlueHDi Diesel versions only (depending on the country of sale), the degree of deterioration of the engine oil is also taken into account.



The vehicle's odometer is displayed in area **A** of the display screen and the trip recorder in area **B**.

The service indicator appears when approaching a servicing point:

- it indicates the distance before the next service is due,
- it displays the servicing interval in two ways,

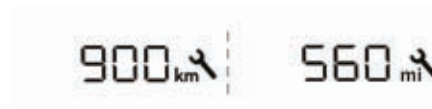

- it remains displayed if the service is overdue,

The service indicator does not appear if it is more than 2 000 miles (3 000 km) before the next service is due.



## Servicing reminder

### Between 600 miles (1 000 km) and 1 800 miles (3 000 km) remain before the next service is due

For 7 seconds after the ignition is switched on, the spanner symbolising the service operations comes on. The distance recorder display line indicates the distance remaining before the next service is due.

**Example:** 1 700 miles (2 800 km) remain before the next service is due.

For 7 seconds after the ignition is switched on, the screen indicates:

2800 km | 1700 mi

7 seconds after the ignition is switched on, **the spanner goes off**; the distance recorder resumes its normal operation. The screen then indicates the total and trip distances.

### Less than 600 miles (1 000 km) remain before the next service is due

**Example:** 560 miles (900 km) remain before the next service is due.

For 7 seconds after the ignition is switched on, the screen indicates:

900 km | 560 mi

7 seconds after the ignition is switched on, the distance recorder resumes its normal operation. **The spanner remains on** to indicate that a service must be carried out soon.

### Service overdue

For 7 seconds after the ignition is switched on, **the spanner flashes** to indicate that the service must be carried out as soon as possible.

**Example:** the service is overdue by 186 miles (300 km).

For 7 seconds after the ignition is switched on, the screen indicates:

-300 km | -186 mi

7 seconds after the ignition is switched on, the distance recorder resumes its normal operation. **The spanner remains on.**

**i** For BlueHDi Diesel versions, this alert is also accompanied by the fixed illumination of the Service warning lamp, when the ignition is switched on. The distance remaining may be weighted by the time factor, depending on the driving conditions. Therefore, the spanner may also come on if you have exceeded the period since the last service, indicated in the manufacturer's service schedule. For BlueHDi Diesel versions, the spanner can also come on early, according to the degree of deterioration of the engine oil. The deterioration of the engine oil depends on the conditions in which the vehicle is used.

## Resetting the service indicator

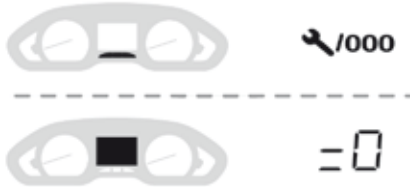

After each service, the service indicator must be reset to zero.

If you have carried out the service on your vehicle yourself:

- ☞ switch off the ignition,
- ☞ press and hold the trip distance recorder reset button,
- ☞ switch on the ignition; the distance recorder display begins a countdown,
- ☞ when the display indicates "**=0**", release the button; the spanner disappears.

**i** If you have to disconnect the battery following this operation, lock the vehicle and wait at least 5 minutes for the reset to be registered.

## Advice

### Retrieving the service information

You can access the service information at any time.

- ☞ Press the trip distance recorder reset button.

The service information is displayed for a few seconds, then disappears.

### Trip recorder reset



With the trip mileage displayed, press the button for a few seconds.

## Touch screen



It gives access to:

- menus for adjusting settings for vehicle functions and systems,
- audio and display configuration menus,
- audio system and telephone controls and the display of associated information.

And, depending on equipment, it allows:

- the display of alert messages and the visual parking sensors information,
- access to the controls for the navigation system and Connected Services, and the display of associated information.

**!** As a safety measure, the driver should only carry out operations that require close attention, with the vehicle stationary.

Some functions are not accessible when driving.

### Recommendations

It is necessary to press firmly, particularly for "flick" gestures (scrolling through lists, moving the map...).

A light wipe is not enough.

The screen does not recognise pressing with more than one finger.

This technology allows use at all temperatures and when wearing gloves.

Do not use pointed objects on the touch screen.

Do not touch the touch screen with wet hands.

Uses a soft clean cloth to clean the touch screen.

### State of indicator lamps

Some buttons contain an indicator lamp that gives the state of the corresponding function. Green indicator: you have switched on the corresponding function.

Orange indicator: you have switched off the corresponding function.

# Trip computer

## Instrument panel screen

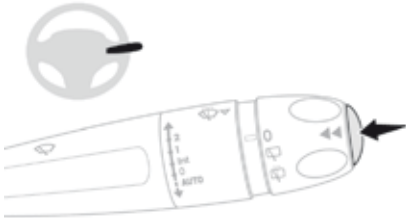

- Each press on the end of the **wiper control stalk** displays the information in turn.

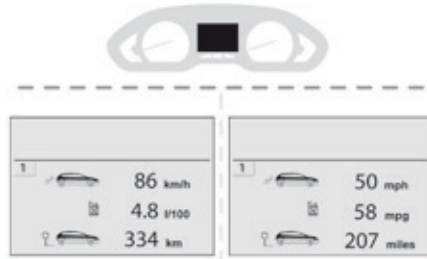

- The current information with:
  - the range,
  - the current fuel consumption,
  - the Stop & Start time counter.
- Trip "1" with:
  - the average speed,
  - the average fuel consumption,
  - the distance travelled, for the first trip.
- Trip "2" with:
  - the average speed,
  - the average fuel consumption,
  - the distance travelled, for the second trip.

## Trip reset

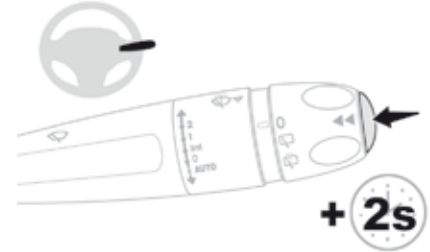

- When the trip required is displayed, press the control for more than 2 seconds or use the left hand thumb wheel of the steering mounted controls.
- Trips "1" and "2" are independent but their use is identical.
- For example, trip "1" can be used for daily figures, and trip "2" for monthly figures.

### Advice

Even though the definition of each type of information is common, the symbols are not; the touch screen symbols are shown.



## Touch screen

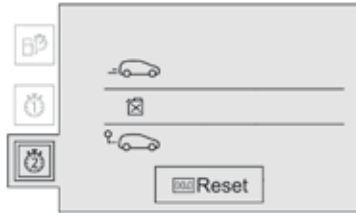

### MENU

☞ Press the **MENU** button to display the main menu.



☞ Select the "**Driving**" menu.

☞ Select the desired tab using your finger.

Successively:

### Current information



#### Range

(miles or km)

The distance that can be travelled using the remaining fuel in the tank (based on the average fuel consumption over the last few miles).



This value can vary following a change in driving conditions or the relief of the road, giving rise to a big difference in current fuel consumption.

Once the remaining range is below 20 miles (30 km), dashes are displayed. After topping-up with at least 5 litres of fuel, the range is recalculated and displayed if it exceeds 60 miles (100 km).



If dashes instead of figures continue to be displayed when driving, contact a PEUGEOT dealer or a qualified workshop.



#### Current fuel consumption

(l/100 km or km/l or mpg)

Calculated over the last few seconds.



This function is only displayed above 20 mph (30 km/h).



#### Stop & Start time counter (if function present)

(In minutes / seconds - hours / minutes)

If your vehicle has Stop & Start, a time counter records the periods in STOP mode during a journey.

It is reset to zero every time the ignition is switched on using the key.



**Trip "1"**



**Trip "2"**

For each separate trip:



**Average fuel consumption**

(l/100 km or km/l or mpg)

Calculated since the last time the trip was reset.



**Average speed**

(km/h or mph)

Calculated since the last time the trip was reset.



**Distance travelled**

(km or miles)

Calculated since the last time the trip was reset.

## Trip reset

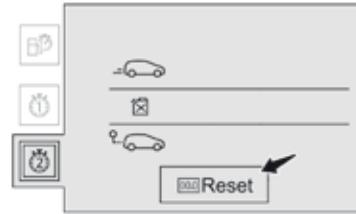

000

When the desired trip is displayed, press the reset button.

Trips "1" and "2" are independent but their use is identical.

For example, trip "1" can be used for daily figures, and trip "2" for monthly figures.

# Date and time

## Touch screen

**MENU** Press **MENU** to display the "MAIN MENU".



Select "**Settings**".



Select "**Secondary page**".



In the secondary page, select "**Time/Date**".

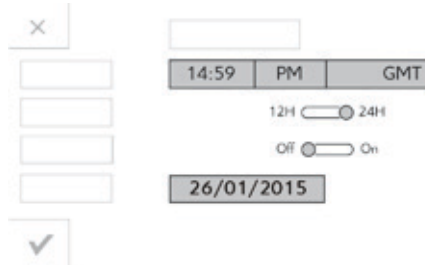

Select "**Adjust time**" or "**Adjust date**".



Modify the setting using the virtual keypad then confirm.



Press "**Confirm**" to save and quit.

## Instrument panel



- Each press of this button moves between the following settings:
- hours,
  - minutes,
  - 12 or 24 hour format.

# Lighting dimmer

System for the manual adjustment of the brightness of the instrument panel and the touch screen to suit the ambient light level.



## Two buttons

With the exterior lighting on:



☞ Press this button to increase the brightness.



☞ Press this button to reduce the brightness.

As soon as the lighting reaches the required level of brightness, release the button.

## One button



☞ Press this button to adjust the brightness,

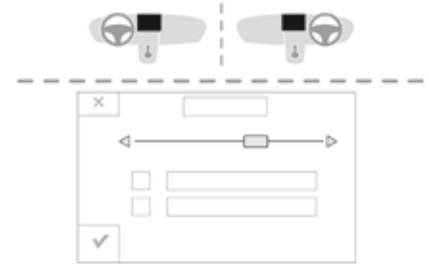

☞ release the button when the desired level is reached.

**i** With the vehicle lighting off or in day mode (daytime running lamps on), pressing the button has no effect.



## Touch screen

### Adjustment

- MENU** ☞ Press **MENU** to display the **"MAIN MENU"**.
-  ☞ Select **"Settings"**.
-  ☞ Select **"Secondary page"**.
-  ☞ Select **"Screen settings"**.
- ☞ Adjust the brightness by moving the cursor.

## Remote control

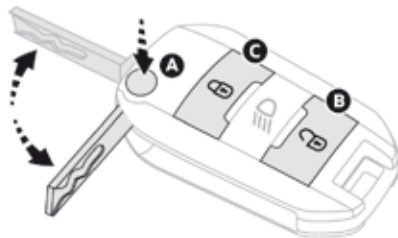

- A. Unfolding / Folding.
- B. Unlocking.  
Disarming the alarm.
- C. Locking.  
Locating the vehicle.  
Arming the alarm.

## Doors

### Complete unlocking

#### Using the key

- ☞ Turn to the front.

#### Using the remote control



- ☞ Press.

### Selective unlocking

Complete unlocking is activated by default.

#### In the "Driving assistance" menu



This is set in the "**Driving assistance**" menu, then "**Vehicle settings**" and "**Vehicle access**".

### Using the remote control



- ☞ Press once to unlock the driver's door only.
- ☞ Press twice in succession to unlock the other doors and the boot.

**i** Unlocking is confirmed by rapid flashing of the direction indicators for approximately 2 seconds. According to version, the electric door mirrors unfold at the same time as the first unlocking action.

## Locating your vehicle



☞ A press switches on the vehicle's lighting and flashes the direction indicators for a few seconds to help you locate your vehicle in a car park.

## Guide-me-home lighting



Make a long press on this button to operate the guide-me-home lighting (switching on the sidelamps, dipped beams and number plate lamps).

A second press before the end of the timed period cancels the guide-me-home lighting.

## 3-door

### Access to the rear seats

#### Folding the front seat forward

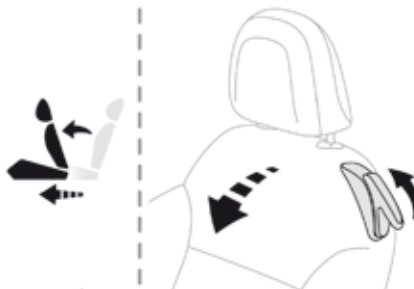

##### Standard model

☞ Pull **only** this control upwards to fold the backrest and slide the whole seat forward. The front seat returns to its original position when straightening the backrest.

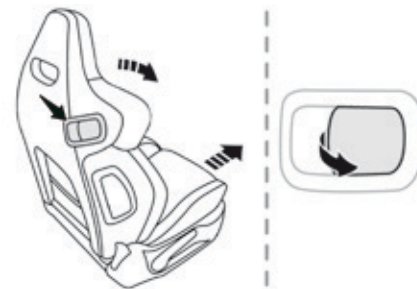

##### Sport model

☞ Pull **only** this control forward to fold the seat backrest and move the whole seat forward.

The front seat returns to its original position when straightening the backrest.

**!** Ensure that no object or person might prevent the seat runners returning to their original position; the return to this position is necessary to secure the seat.  
Ensure that the seat belt has reeled in correctly so as to not impede passengers' access to the rear seats.

## Locking - Key

### Locking

#### Using the key

- ☞ Turn the key towards the rear of the vehicle.

#### Using the remote control



- ☞ Press.

Maintaining the locking action (key or remote control) automatically closes the windows.

- i** Locking is confirmed by fixed illumination of the direction indicators for approximately 2 seconds. According to version, the electric door mirrors fold at the same time. The folding and unfolding of the electric door mirrors can be deactivated by a PEUGEOT dealer or a qualified workshop.

- i** If one of the doors or the boot is still open or if an electronic key has been left inside the vehicle, the locking does not take place. When the vehicle is locked, if it is unlocked inadvertently, it will automatically lock itself again after about 30 seconds, unless a door is opened.

- !** As a safety measure (passengers on board), never leave the vehicle, even for a short period, without taking your key with you.

### Folding the key

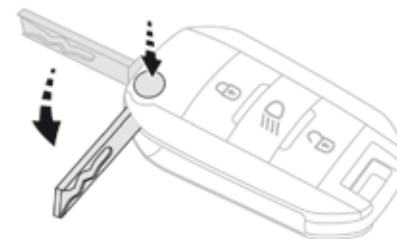

- ☞ Press this button before folding the key.

- !** If you do not press the button, there is a risk of damaging the remote control.

## Back-up door locking

For mechanically locking and unlocking the doors in the event of a fault with the central locking system or a battery failure.

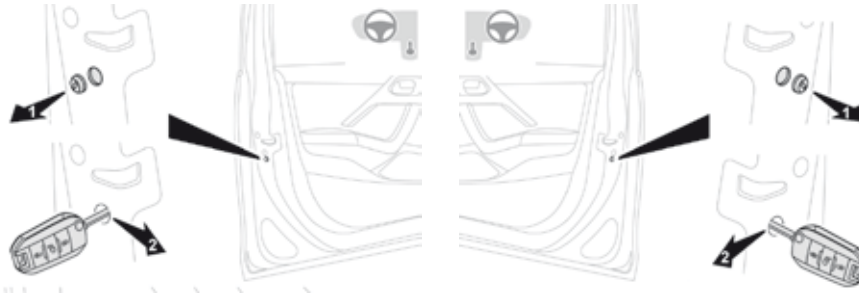

### Driver's door

Insert the key in the lock to lock or unlock the door.

### Passenger doors

- ☞ On the rear doors, check that the child lock is not on.
- ☞ Remove the black cap located on the edge of the door, using the key.
- ☞ Insert the key into the aperture without forcing, then without turning, move the latch sideways towards the inside of the door.
- ☞ Remove the key and refit the cap.



## Deadlocking

- ! (depending on version)  
Deadlocking renders the exterior and interior door controls inoperative. It also deactivates the manual central control button.  
Therefore, never leave anyone inside the vehicle when it is deadlocked.

### Using the key

- ☞ Turn the key to the rear in the driver's door lock.
- ☞ Turn the key to the rear again within 5 seconds to deadlock the vehicle.

### Using the remote control



- ☞ Press.
- ☞ Press again within 5 seconds to deadlock the vehicle.

- i Deadlocking is confirmed by fixed illumination of the direction indicators for approximately 2 seconds. Depending on version, the electric door mirrors fold at the same time.

## From the inside



### Locking

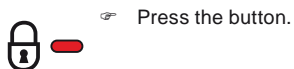

☞ Press the button.

This allows the doors and the boot to be locked.  
The indicator lamp in the button comes on.

**i** If one of the doors is open, locking of the doors from the inside does not take place.

### Unlocking



☞ Press the button again.

The indicator lamp in the button goes off.

#### **!** When locking / deadlocking from outside

When the vehicle is locked or deadlocked from outside, the switch does not operate.

- ☞ After normal locking, pull the interior door lever to unlock the vehicle.
- ☞ After deadlocking, you have to use the remote control or the key to unlock the vehicle.

### Automatic central locking

The doors can lock automatically while driving (speed above 6 mph [10 km/h]).  
To turn this function on or off (on by default).



☞ press and hold the button until there is an audible signal and/or a message in the screen.

**!** Driving with the doors locked may make access to the passenger compartment by the emergency services more difficult in an emergency.

# Alarm

The alarm provides the following types of monitoring:



## - Exterior perimeter

The system checks for opening of the vehicle. The alarm is triggered if anyone tries to open a door, the boot, the bonnet...

## - Interior volumetric

The system checks for any variation in the volume in the passenger compartment. The alarm is triggered if anyone breaks a window, enters the passenger compartment or moves inside the vehicle.

## - Tilt\*

The system monitors changes in the attitude of the vehicle. The alarm is triggered if the vehicle is lifted, moved or damaged.

For all work on the alarm system, contact a PEUGEOT dealer or a qualified workshop.

## i Self-protection function

The alarm is triggered if the battery, the central control or the siren wiring is put out of service or damaged.

## Total protection

### Activation

- ☞ Switch off the ignition and get out of the vehicle.
- ☞ Press the locking button on the remote control.



The alarm monitoring system is active (armed): the indicator lamp in the button flashes once per second.

### Timing:

The exterior perimeter monitoring is activated after a delay of 5 seconds.  
The interior volumetric monitoring after a delay of 45 seconds.  
If an opening (door, boot...) is not closed fully, the vehicle is not locked but the exterior perimeter monitoring will be activated after a delay of 45 seconds at the same time as the interior volumetric monitoring.

## Automatic activation (depending on version)

Monitoring is active 2 minutes after the last door or the boot is closed.

- ☞ To avoid triggering the alarm on entering the vehicle, first press the button on the remote control before opening a door.

## Deactivation



- ☞ Press the unlocking button on the remote control.



The alarm system is switched off (disarmed): the indicator lamp in the button goes off.

\* On GTi version.

## Protection - perimeter monitoring only

Deactivate the interior volumetric monitoring (and tilt monitoring, if fitted to your vehicle) to avoid unwanted triggering of the alarm in certain cases such as:

- the presence of a pet in the vehicle,
- a window partially open,
- washing your vehicle.

### Deactivation of the volumetric monitoring

Tilt monitoring is deactivated, if fitted to your vehicle.

- ☞ Switch off the ignition.



- ☞ Within ten seconds, press the button until the indicator lamp is on continuously.

- ☞ Get out of the vehicle.



- ☞ Press the locking button on the remote control immediately.

The exterior perimeter monitoring alone is activated: the indicator lamp in the button flashes once per second.

- i** To be effective, the deactivation must be carried out each time the ignition is switched off.

## Locking the vehicle without activating the alarm

- i** ☞ Lock or deadlock the vehicle using the key in the driver's door lock.

## Triggering of the alarm

When the alarm is triggered the siren sounds and the direction indicators flash for thirty seconds.

The monitoring functions remain active until the alarm has been triggered eleven times in succession.



- When the vehicle is unlocked using the remote control, rapid flashing of the indicator lamp in the button informs you that the alarm was triggered during your absence. When the ignition is switched on, this flashing stops immediately.



## Advice

### Remote control fault

To deactivate the monitoring functions:

- ☞ Unlock the vehicle using the key in the driver's door lock.
- ☞ Open the door; the alarm is triggered.
- ☞ Switch on the ignition; the alarm stops. The indicator lamp in the button goes off.

### Alarm fault

When the ignition is switched on, fixed illumination of the indicator lamp in the button indicates a fault with the system.

Have it checked by a PEUGEOT dealer or a qualified workshop.

## Boot Opening

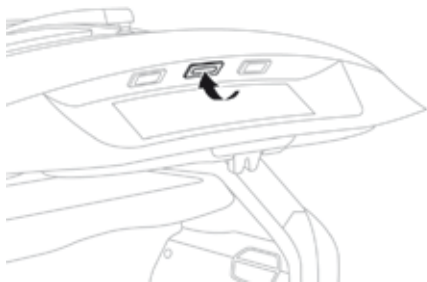

Using the key.  
Using the remote control.

- After unlocking the boot or the vehicle, press the opening control which releases the tailgate, and then guide it open.

## Closing

- Lower the tailgate using the interior grab handle.
- If necessary, press down on the tailgate to fully close it.

## Boot still open



**With the engine running**, this is signalled by:

- this warning lamp coming on,
- an alert message displayed for a few seconds.

**With the vehicle moving** (speed higher than 6 mph (10 km/h)), this is signalled by:

- this warning lamp coming on,
- an alert message displayed for a few seconds,
- an audible signal.

## Advice

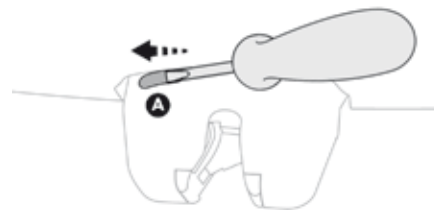

## Tailgate release

System for mechanical unlocking of the boot in the event of a central locking malfunction.

## Unlocking

- Fold back the rear seats to gain access to the lock from inside the boot.
- Insert a small screwdriver into hole **A** of the lock to unlock the tailgate.

## Remote control problem

Following disconnection of the vehicle battery, replacement of the remote control battery or in the event of a remote control malfunction, you can no longer unlock, lock or locate your vehicle.

- ☞ First of all, use the key in the lock to unlock or lock your vehicle.
  - ☞ Then, reinitialise the remote control.
- If the problem persists, contact a PEUGEOT dealer as soon as possible.

## Reinitialisation

- ☞ Switch off the ignition.
- ☞ Turn the key to position **2 (Ignition)**.
- ☞ Press the closed padlock immediately for a few seconds.
- ☞ Switch off the ignition and remove the key from the ignition switch.

The remote control is fully operational again.



Do not throw the remote control batteries away, they contain metals which are harmful to the environment. Take them to an approved collection point.

## Changing the battery

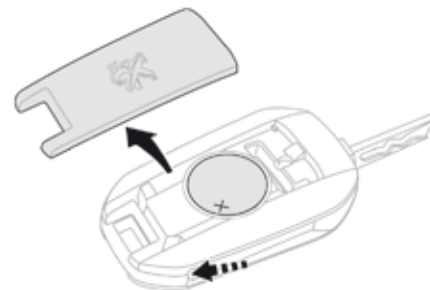

Battery ref.: CR1620 / 3 volts.

### SERVICE

If the battery is flat, you are informed by lighting of this warning lamp in the instrument panel, an audible signal and a message in the screen.

- ☞ Unclip the cover using a screwdriver in the cutout.
- ☞ Remove the cover.
- ☞ Extract the flat battery from its location.
- ☞ Place the new battery into its location observing the original direction.
- ☞ Clip the cover in place.

## **!** Lost keys

Go to a PEUGEOT dealer with the vehicle's registration document, your personal identification documents and if possible the key code label.

The PEUGEOT dealer will be able to look up the key code and the transponder code required to order a new key.

## Remote control

The high frequency remote control is a sensitive system; do not operate it while it is in your pocket as there is a possibility that it may unlock the vehicle, without you being aware of it.

Do not repeatedly press the buttons of your remote control out of range and out of sight of your vehicle. You run the risk of stopping it from working and the remote control would have to be reinitialised.

No remote control can operate when the key is in the ignition switch, even when the ignition is switched off, except for reinitialisation.

## Anti-theft protection

Do not make any modifications to the electronic engine immobiliser system; this could cause malfunctions.

## Locked vehicle

Driving with the doors locked may make access to the passenger compartment by the emergency services more difficult in an emergency.

As a safety precaution, never leave children alone in the vehicle, except for a very short period.

In all cases, it is essential to remove the key from the ignition switch when leaving the vehicle.

## Second-hand vehicle

Have the pairing of all of the keys in your possession checked by a PEUGEOT dealer, to ensure that only your keys can be used to open and start the vehicle.

# Window controls

## Manual mode



### Open



Press the control without going past the point of resistance. The window stops as soon as the control is released.

### Close



Pull the control without going past the point of resistance. The window stops as soon as the control is released.



Inhibit the rear controls.

## Automatic mode

(depending on version)

### Open



Press the control, going past the point of resistance. The window opens completely after releasing the control. Pressing again stops the movement of the window.

### Close



Pull the control, going past the point of resistance. The window closes completely after releasing the control. Pulling again stops the movement of the window.

**i** The electric window controls remain operational for approximately 1 minute after the key has been removed. Once this time has elapsed, the electric windows will not operate. To reactivate them, switch the ignition on again.

## Anti-pinch

(depending on version)

When the window rises and meets an obstacle, it stops and immediately partially lowers again.



In the event of unwanted opening of the window when closing automatically, press the control until the window opens completely, then pull the control immediately until the window closes. Continue to hold the control for approximately 1 second after the window has closed.

The safety anti-pinch function is not active during this operation.



## Inhibition



For the safety of your children, press the control to prevent operation of the windows of the rear doors, irrespective of their position.

With the warning lamp on, the rear switches are deactivated. With the warning lamp off, the switches are active.

## Advice

### Reinitialisation

Following reconnection of the battery, the safety anti-pinch function must be reinitialised. The safety anti-pinch is not active during these operations:

- lower the window completely, then raise it; it will rise in steps of a few centimetres each time the switch is pressed. Repeat the operation until the window closes completely,
- press and hold the switch upwards for at least 1 second after reaching this position, window closed.

- ! Always remove the key when leaving the vehicle, even for a short time. In the event of contact during operation of the windows, you must reverse the movement of the window. To do this, press the switch concerned. When operating the passenger electric window controls, the driver must ensure that no one prevents the correct closing of the windows. The driver must ensure that passengers use the electric windows correctly. Be aware of children when operating the windows.

## PEUGEOT i-Cockpit



To make the most of the special ergonomics of the PEUGEOT i-Cockpit, adjust in the following order:

- the height of the head restraint,
- the seat backrest angle,
- the seat cushion height,
- the longitudinal position of the seat,
- the reach and then height of the steering wheel,
- the interior and door mirrors.

**i** Once these adjustments have been made, ensure that from your driving position you can see the "head-up" instrument panel clearly, over the reduced diameter steering wheel.

### Adjusting the steering wheel



- ☞ **When stationary**, pull the control lever to release the steering wheel adjustment mechanism.
- ☞ Adjust the height and reach of the wheel to suit your driving position.
- ☞ Push the control lever to lock the steering wheel adjustment mechanism.

**!** As a safety measure, this operation must only be carried out with the vehicle stationary.

## Front seats

### Standard Adjustments

#### Forwards-backwards

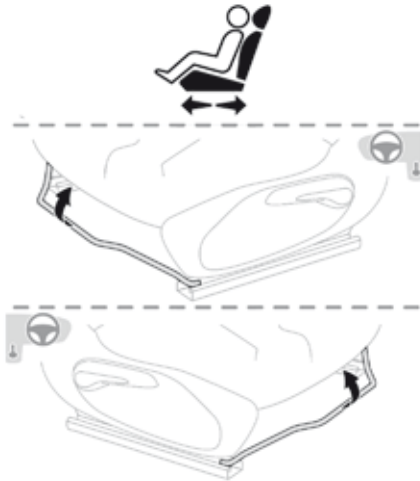

- ☞ Raise the control and slide the seat forwards or backwards.

#### Height

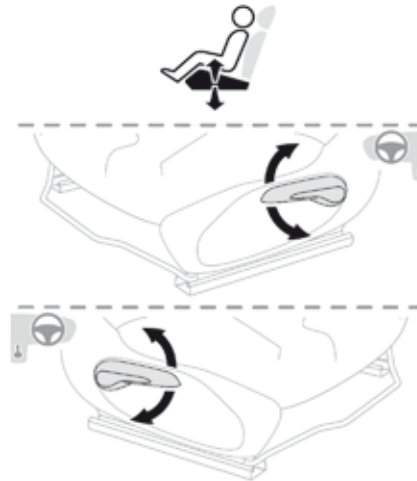

- ☞ Pull the control upwards to raise or push it downwards to lower, as many times as required, to obtain the position required.

#### Backrest

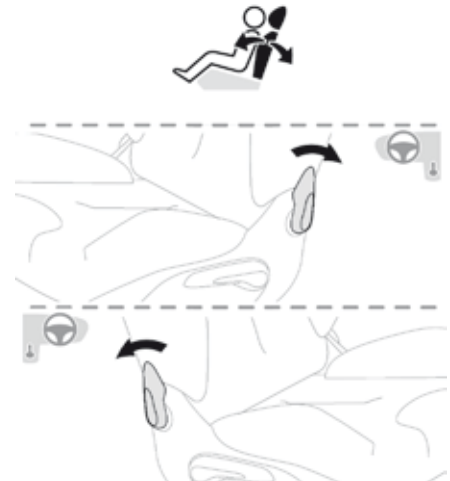

- ☞ Push the control rearwards.

## Head restraints

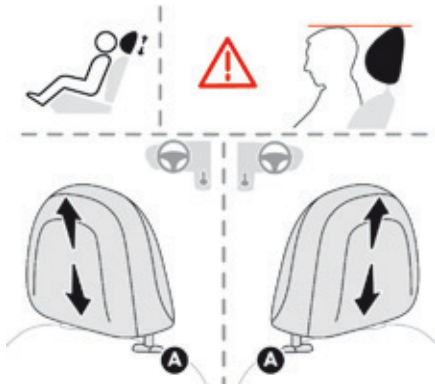

- ☞ To raise the head restraint, pull it upwards.
- ☞ To remove the head restraint, press the lug **A** and pull the head restraint upwards.
- ☞ To put the head restraint back in place, engage the head restraint stems in the openings, keeping them in line with the seat back.
- ☞ To lower the head restraint, press the lug **A** and the head restraint at the same time.

**!** The head restraint has a frame with notches which prevent it from lowering; this is a safety device in case of impact. **The adjustment is correct when the upper edge of the head restraint is level with the top of the head.** Never drive with the head restraints removed; they must be in place and adjusted correctly.

**!** Before moving the seat backwards, ensure that there is nothing that might prevent the full travel of the seat, so as to avoid the risk of jamming the seat caused by the presence of objects on the floor behind the seat or rear passengers. If the seat jams, stop the movement immediately.

## Bucket seats

### Adjustments

#### Forwards-backwards

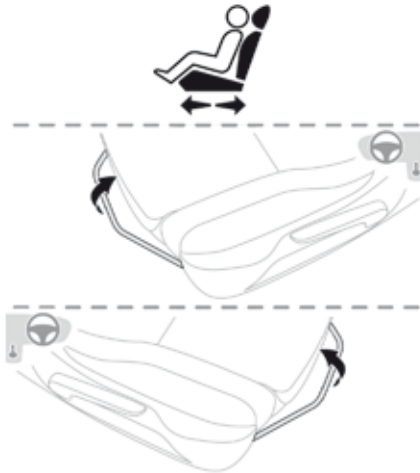

- ☞ Lift the control and slide the seat forwards or backwards.

#### Height

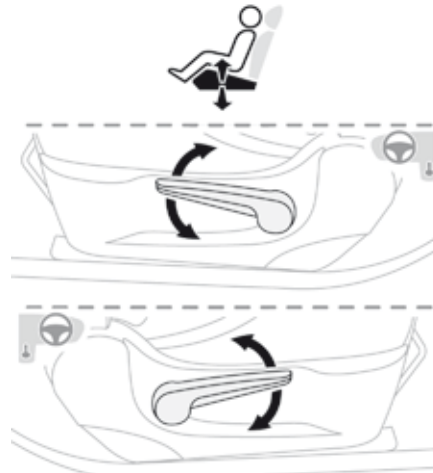

- ☞ Pull the handle upwards to raise or push it downwards to lower, as many times as necessary to obtain the required position.

#### Backrest

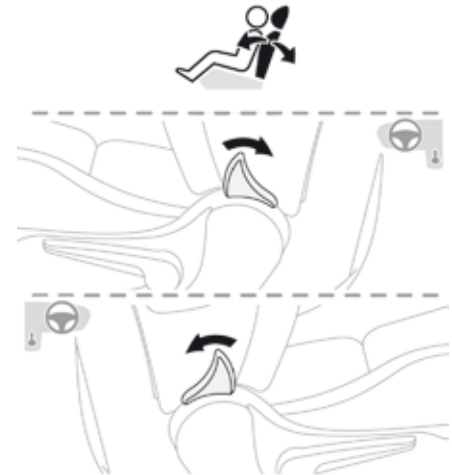

- ☞ Push the handle towards the rear and move the seat backrest forwards or backwards.

## Additional adjustments

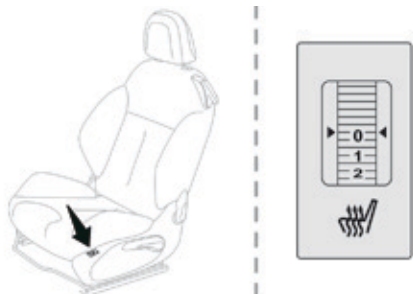

### Heated seats

With the engine running, the front seats can be heated separately.

☞ Use the adjustment wheel, select the level of heating required:

- 0: Off.
- 1: Low.
- 2: Medium.
- 3: High.



### Armrest

Comfort and storage system for the driver and front passenger.

#### Cover with opening lever

☞ Lift the lever to raise the lid.



#### Storage space in the console

☞ Pull the armrest fully up.

## One-piece rear seats

Bench seat with fixed one-piece cushion and folding one-piece backrest.

### Backrest

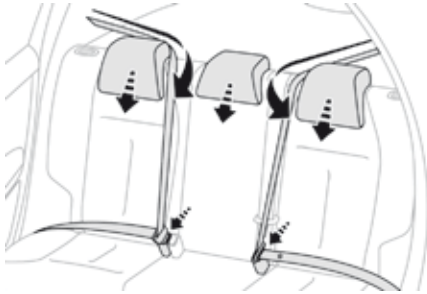

#### Folding the backrest

- ☞ Move the front seats forward if necessary.
- ☞ Position the outer seat belts on the backrest and buckle them.
- ☞ Lower the head restraints to the lowest position.

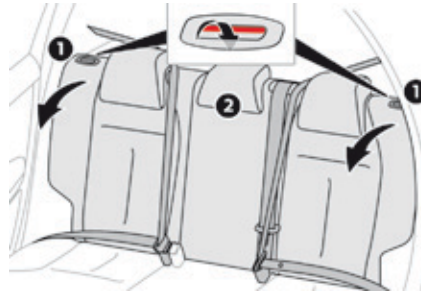

- ☞ Release the seat backrest **2** by press both controls **1** simultaneously.
- ☞ Fold the seat backrest **2** on to the fixed cushion.

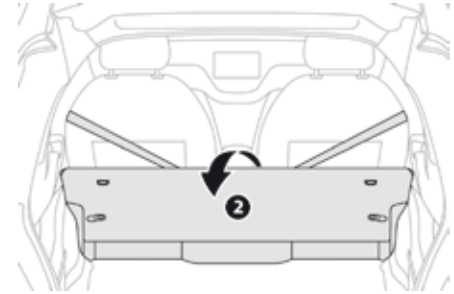

#### Raising the seat backrest

- ☞ Raise the seat backrest **2**.
- ☞ Latch the backrest in place, the red indicators on the controls **1** are no longer visible.
- ☞ Unbuckle and return the outer seat belts to their normal positions ready for use.

## Head restraints

These have one position for use (up) and a stowed position (down).

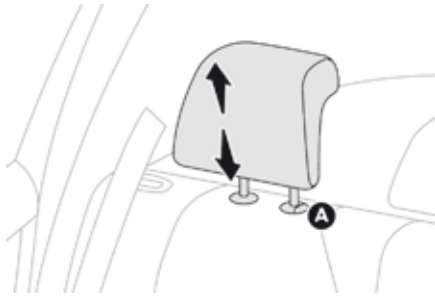

They can be removed and are interchangeable side to side.

To remove a head restraint:

- ☞ pull the head restraint fully up,
- ☞ then, press the lug **A**.

## 2/3 - 1/3 split bench rear seat

Bench seat with fixed one-piece cushion and split backrest (left hand 2/3, right hand 1/3) which can be folded individually to adapt the load space in the boot.

### Seat backrest

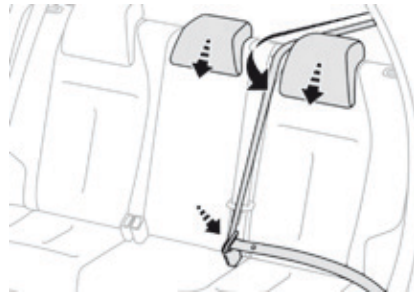

### Folding the backrest

- ☞ Move the corresponding front seat forward if necessary.
- ☞ Position the corresponding outer seat belt against the backrest and buckle it.
- ☞ Fully lower or remove the head restraint.

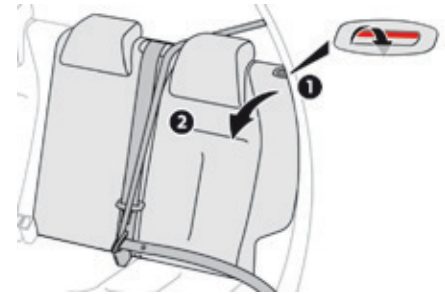

- ☞ Release the backrest by pressing control **1** for the seat backrest **2**.
- ☞ Fold the seat backrest **2** on to the fixed cushion.

The rear cushion is not removable.



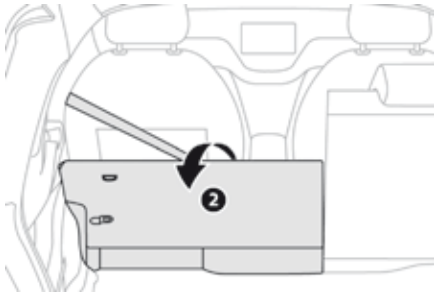

### Repositioning the seat backrest

- ☞ Raise the seat backrest **2**.
- ☞ Secure it, checking that the red indicator in the control **1** is no longer visible.
- ☞ Unbuckle and reposition the seat belts ready for use.
- ☞ Refit the head restraint(s).

**!** When folding the seat, the centre seat belt should not be fastened, but laid out flat on the seat.

**!** When repositioning the seat backrest, take care not to trap the seat belts.

**i** The rear seat cushion does not fold, just the seat backrest can be folded to increase the boot loading space.

### Head restraints

These have one position for use (up) and a stowed position (down).

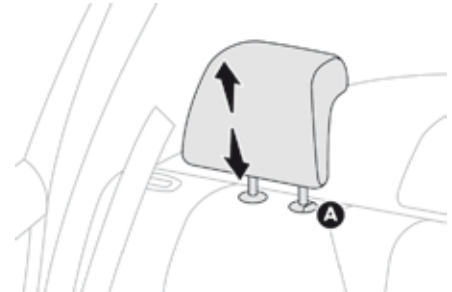

They can be removed and are interchangeable side to side.

To remove a head restraint:

- ☞ pull the head restraint fully up,
- ☞ then, press the lug **A**.

**!** Never drive with the head restraints removed; they must be fitted and correctly adjusted.

# Ventilation

## General points

### Air intake

The air circulating in the passenger compartment is filtered and originates either from the outside via the grille located at the base of the windscreen or from the inside in air recirculation mode.

### Air intake flow

The incoming air follows various paths depending on the controls selected by the driver:

- direct arrival in the passenger compartment (air intake),
- passage through a heating circuit (heating),
- passage through a cooling circuit (air conditioning).

### Control panel

The controls of this system are grouped together on the control panel on the centre console.

### Air distribution

The incoming air is distributed via various outlets:

- windscreen demisting-defrosting vents,
- front side window demisting-defrosting vents,
- side adjustable air vents,
- central adjustable air vents,
- air outlets to the front footwells,
- air outlets to the rear footwells.

## Advice

**i** In order for the ventilation and air conditioning to be fully effective, follow the operation and maintenance guidelines below:

- ☞ To obtain an even air distribution, take care not to obstruct the exterior air intake grilles located at the base of the windscreen, the nozzles, the vents and the air outlets, as well as the air extractor located in the boot.
- ☞ Do not cover the sunshine sensor, located on the dashboard; this is used for regulation of the air conditioning system.
- ☞ The air conditioning system only works with the engine running.
- ☞ Operate the air conditioning system for at least 5 to 10 minutes, once or twice a month to keep it in perfect working order.
- ☞ Ensure that the passenger compartment filter is in good condition and have the filter elements replaced regularly.

We recommend the use of a combined passenger compartment filter. Thanks to its special active additive, it contributes to the purification of the air breathed by the occupants and the cleanliness of the passenger compartment (reduction of allergic symptoms, bad odours and greasy deposits).

- ☞ To ensure correct operation of the air conditioning system, you are also advised to have it checked regularly as recommended in the warranty and maintenance record.
- ☞ If the system does not produce cold air, switch it off and contact a PEUGEOT dealer or a qualified workshop.

When towing the maximum load on a steep gradient in high temperatures, switching off the air conditioning increases the available engine power and so improves the towing ability.

### **i** Stop & Start

The heating and air conditioning systems only work when the engine is running.

To maintain a comfortable temperature in the passenger compartment, you can temporarily deactivate the Stop & Start system.

For more information on Stop & Start, refer to the corresponding section.



If after an extended stop in sunshine, the interior temperature is very high, first ventilate the passenger compartment for a few moments.

Put the air flow control at a setting high enough to quickly change the air in the passenger compartment.

The air conditioning system does not contain chlorine and does not present any danger to the ozone layer.



The condensation created by the air conditioning results in a discharge of water under the vehicle which is perfectly normal.

## Passenger compartment filter









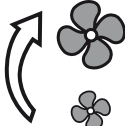
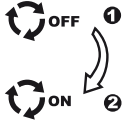

Depending on the environment (e.g. dusty atmosphere) and the use of the vehicle (e.g. city driving), **replace it twice as often if necessary.**

A clogged passenger compartment filter may have an adverse effect on the performance of the air conditioning system and generate undesirable odours.

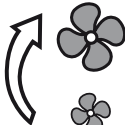
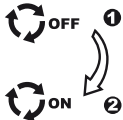
Refer to the manufacturer's service schedule.

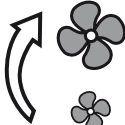
## Suggested interior settings

I require...	Heating or Manual air conditioning				
	Air distribution	Air flow	Recirculation of interior air / Intake of exterior air	Temperature	Manual AC
HOT					
COLD					<b>ON</b>
DEMISTING DEFROSTING					<b>ON</b>

**Digital air conditioning:** use the automatic mode in preference by pressing the "AUTO" button.

# Heating / Ventilation

## Manual mode



### Temperature



- ☞ Turn the knob from blue (cold) to red (hot) to adjust the temperature to your wishes.

### Air flow



- ☞ Turn the knob from position 1 to position 6, to obtain the desired air flow.

**i** If you place the air flow control at position 0 (off), the temperature in the vehicle will no longer be maintained. However, a slight flow of air can still be felt due to the movement of the vehicle.

## Air distribution



Windscreen and side windows.



Windscreen, side windows and footwells.



Footwells.



Centre and side air vents.



The air distribution can be modulated by placing the knob at an intermediate position.

## Air intake / Air recirculation

Recirculation of the air in the vehicle isolates the passenger compartment from exterior odours and fumes.

Return to the intake of exterior air as soon as possible to avoid the risk of deterioration of air quality and misting.



☞ Press the button to recirculate the interior air: the indicator lamp is on.



☞ Press the button again to allow the intake of exterior air: the indicator lamp is off.

# Air conditioning

## Manual mode



### Temperature



To adjust the temperature, turn the knob from blue (cold) to red (hot) to suit your requirements.

### Air flow



To adjust the air flow, turn the knob from position 1 to position 6 to obtain an adequate air flow for your comfort.

**i** If you put the air flow control in position 0 (system off), the temperature is no longer controlled. However, a slight flow of air can still be felt, resulting from the movement of the vehicle.

## Air distribution



Windscreen and side windows.



Windscreen, side windows and footwells.



Footwells.



Central and side vents.



The air distribution can be adapted by placing the dial in an intermediate position.

## Air intake / Air recirculation

The recirculation of interior air insulates the passenger compartment from exterior odours and smoke.

Return to exterior air intake as soon as possible to prevent deterioration of the air quality and the formation of mist.



☞ Press the button to recirculate the interior air: the indicator lamp is on.



☞ Press the button again to allow fresh air into the passenger compartment: the indicator lamp is off.

## Air conditioning On / Off

The air conditioning is designed to operate effectively in all seasons, with the windows closed. It enables you to:

- lower the temperature, in summer,
- increase the effectiveness of the demisting in winter, above 3 °C.

### Switching on



☞ Press the **"A/C"** button, the button's indicator lamp comes on.

**i** The air conditioning does not operate when the air flow adjustment control is in position **"0"**.

To obtain cooled air more quickly, you can use recirculation of interior air for a few moments. Then return to fresh air intake.

### Switching off



☞ Press the **"A/C"** button again, the button's indicator lamp goes off.

Switching off may affect comfort levels (humidity, condensation).



# Dual-zone digital air conditioning

## AUTO mode

### Automatic programme

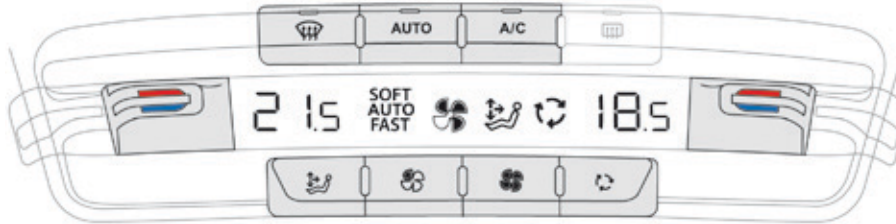

#### Switching on

**AUTO**

- Press the "AUTO" button repeatedly. The indicator lamp comes on at the first press; the mode activated appears in the digital air conditioning screen:

**SOFT  
AUTO**

Provides soft and quiet operation by limiting air flow.

**AUTO**

Offers the best compromise between a comfortable temperature and quiet operation.

**AUTO  
FAST**

Provides strong and effective air flow.

#### Switching off



- Press the "empty fan" air flow button until the fan symbol disappears.

- When the engine is cold, the air flow will only reach its optimum level gradually to prevent too great a distribution of cold air. In cold weather, it favours the distribution of warm air to the windscreen, the side windows and the footwells only.

## Temperature

### Adjustment

The driver and front passenger can each set the temperature to suit their requirements. The value indicated in the screen corresponds to a level of comfort and not to a temperature in degrees Celsius or Fahrenheit.



- Push the button down (blue) to reduce the value or up (red) to increase it.

A setting around 21 enables you to obtain an optimum level of comfort. Depending on your requirements, a setting between 18 and 24 is usual.

In addition, it is recommended that you avoid a left/right setting difference of more than 3.

**i** On entering the vehicle, if the interior temperature is much colder or warmer than the comfort value, there is no need to alter the value displayed in order to obtain the required level of comfort. The system corrects the temperature difference automatically and as quickly as possible.

## Auto - Visibility programme

### Switching on



☞ Press the "**visibility**" button for faster demisting or defrosting of the windscreen and side windows.

The system automatically manages the air conditioning, and the air intake, flow and distribution to the windscreen and side windows to the best effect.

### Switching off

**AUTO**

☞ Press the "**visibility**" button again or the "**AUTO**" button, the indicator lamp in the button goes off and the indicator lamp in the "**AUTO**" button comes on.

The system reverts to the previous settings used.

**AUTO**

☞ Press the "**AUTO**" button again to return to the automatic comfort programme.

**i** For maximum cooling or heating of the passenger compartment, you can exceed the minimum value of 14 or the maximum value of 28.



☞ Push the button down until "**LO**" is displayed or up until "**HI**" is displayed.

## Air conditioning

The air conditioning is designed to operate efficiently in all seasons, with the windows closed.

It allows you:

- in summer, to lower the temperature,
- in winter, above 3 °C, to improve demisting.

### Switching on

**A/C**

☞ Press the "**A/C**" button, the associated indicator lamp comes on.

The air conditioning cannot operate when the air flow is set to off.

### Switching off

**A/C**

☞ Press the "**A/C**" button again; the associated indicator lamp goes off.

Switching off may cause some problems (humidity, misting).

## Air distribution



☞ Press this button several times in succession to direct the air flow in turn towards:

- the windscreen, the side windows and the footwells,
- the windscreen and side windows (demisting or defrosting),
- the central and side vents,
- the central vents, the side vents and the footwells,
- the footwells.

## Air flow



☞ Press this **"full fan"** button to increase the air flow.

The air flow symbol (a fan) appears in the screen. It is filled in progressively in relation to the value required.



☞ Press this **"empty fan"** button to reduce the air flow.

## Air intake/Air recirculation

### Switching on



☞ Press this button to recirculate the interior air. The indicator lamp in the button comes on and the air recirculation symbol is displayed.

Air recirculation prevents exterior odours and fumes from entering the passenger compartment. It is activated automatically when operating the screen wash.

### Switching off



☞ As soon as possible, press this button again to permit the intake of exterior air and prevent misting. The indicator lamp in the button goes off.



Avoid prolonged operation in interior air recirculation mode (risk of misting and of deterioration of the air quality).

## Manual mode

Depending on your requirements, you can make a different selection from that offered by the system by changing a setting. The other functions will still be controlled automatically.

When you modify a setting, the indicator lamp in the **"AUTO"** button goes off.

## Switching the system off



☞ Press the **"empty fan"** air flow button until the fan symbol disappears and **"---**" appears.

This action switches off all of the functions of the air conditioning system. The temperature is no longer maintained at a comfortable level. However, a slight flow of air, due to the movement of the vehicle, can still be felt.



Avoid driving for too long with the system switched off (risk of misting and of deterioration of the air quality).



Pressing the **"full fan"** button reactivates the system with the settings prior to deactivation.

# Demisting - defrosting

## Windscreen



These markings on the control panel indicate the settings for rapid demisting or defrosting of the windscreen and side windows.

## Manual air conditioning

### Switching on



☞ Put the air flow, temperature and distribution controls to the dedicated marked position.



☞ Press the "A/C" button for air conditioning; the indicator lamp in the button comes on.

### Switching off



☞ Press the "A/C" button again; the indicator lamp in the button goes off.

## Dual-zone digital air conditioning

### Auto - Visibility programme

#### Switching on



☞ Press the "visibility" button to demist or defrost the windscreen and side windows as quickly as possible.

The system automatically manages the air conditioning, air flow and air intake, and provides optimum distribution towards the windscreen and side windows.

#### Switching off



☞ Press the "visibility" button again or on "AUTO"; the indicator lamp in the button goes off and the indicator lamp in the "AUTO" button comes on.

The system reverts to the previous settings.

**i** With Stop & Start, when demisting has been activated, the STOP mode is not available.

## Rear screen

The control button is located on the air conditioning system control panel.

The rear screen demisting/defrosting can only operate when the engine is running.

### On



☞ Press this button to demist/defrost the rear screen and (depending on version) the electric door mirrors. The indicator lamp associated with the button comes on.

### Off

The demisting/defrosting switches off automatically to prevent an excessive consumption of current.



☞ It is possible to stop the demisting/defrosting operation before it is switched off automatically by pressing the button again. The indicator lamp associated with the button goes off.

## Door mirrors

### Demisting - Defrosting



To demist or defrost the electric door mirrors, with the engine running press the heated rear window switch.



### Advice



☞ Switch off the demisting/defrosting of the rear screen and electric door mirrors as soon as appropriate, as lower current consumption results in reduced fuel consumption.

## Courtesy lamp

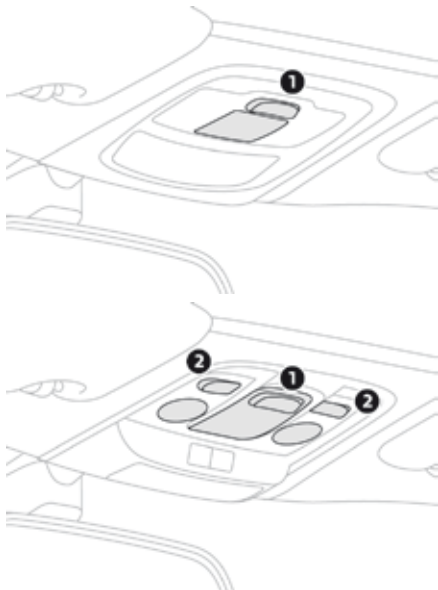

1. Courtesy lamp
2. Map reading lamps



In this position, the lighting comes on gradually:

- when the vehicle is unlocked,
- when the key is removed from the ignition,
- when opening a door,
- when unlocking with the remote control.

It goes off gradually:

- when the vehicle is locked,
- when the ignition is switched on,
- 30 seconds after the last door is closed.



Permanently off.



Permanent lighting.

- i** With the "permanent lighting" mode, the lighting time varies according to the circumstances:
- with the ignition off, approximately 10 minutes,
  - in energy economy mode, approximately 30 seconds,
  - with the engine running, unlimited.

## Map reading lamps



With the ignition on, press the corresponding switch.

**!** Take care to avoid leaving anything in contact with the courtesy lamp.

## Mood lighting



### Switching on

At night, panoramic sunroof light-emitting diodes (LEDs) come on automatically when the sidelamps are switched on.

### Switching off

The interior mood lighting switches off automatically when the sidelamps are switched off.



### Settings



Settings for the mood lighting can be adjusted via the vehicle settings menu in the touch screen.

## Sunroof blind

### Opening

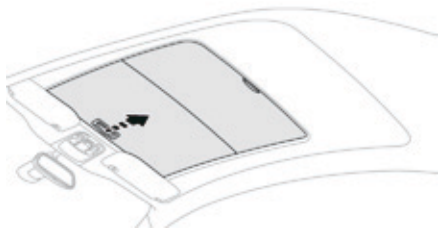

- ☞ Take the blind by its handle and push it rearward to the desired position.

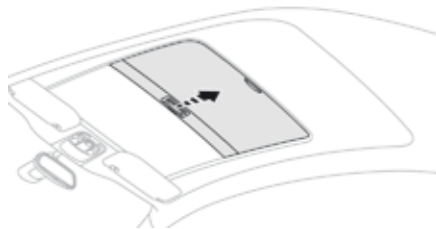

### Closing

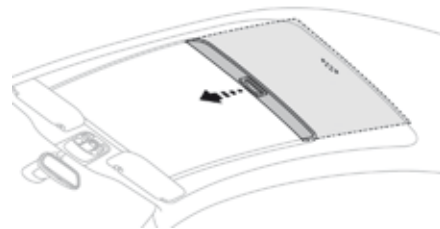

- ☞ Take the blind by its handle and pull it forward to the desired position.



## Interior fittings

### Glove box

Placed in the lower dashboard, it has a lid with a grip that is raised to open it.

It may house:

- ☞ the handbook pack.
- ☞ a water bottle.

### Large open storage

It is in the location for an audio system (depending on version).

### Open storage

At the foot of the centre console:

- 2 locations for standard size cups or cans.
- Door pockets.

### Below a front seat

Location for the warning triangle in its cover or storage box.

## Mats

### Fitting

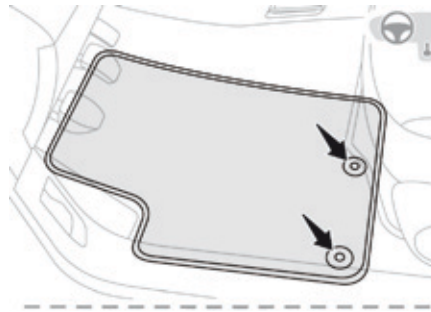

When fitting the mat for the first time, on the driver's side use only the fixings provided in the wallet attached.

The other mats are simply placed on the carpet.

### Removal

To remove the mat on the driver's side:

- ☞ move the seat as far back as possible,
- ☞ unclip the fixings,
- ☞ remove the mat.

### Refitting

To refit the mat on the driver's side:

- ☞ position the mat correctly,
- ☞ refit the fixings by pressing,
- ☞ check that the mat is secured correctly.



To avoid any risk of jamming of the pedals:

- only use mats which are suited to the fixings already present in the vehicle; these fixings must be used,
- never fit one mat on top of another.

The use of mats not approved by PEUGEOT may interfere with access to the pedals and hinder the operation of the cruise control / speed limiter.

The mats approved by PEUGEOT have two fixings located below the seat.

## Ports and sockets - Connectivity

### 12 V socket

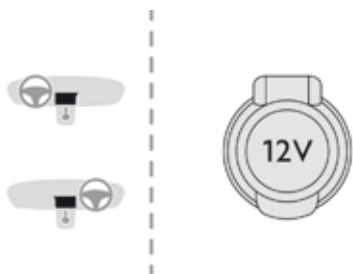

To connect a 12 V accessory (maximum power: 120 Watts), lift the cover and connect a suitable adaptor.

**!** Do not exceed the maximum power rating of the socket (otherwise there is a risk of damaging your portable device).

**i** The connection of an electrical device not approved by PEUGEOT, such as a USB charger, may adversely affect the operation of vehicle electrical systems, causing faults such as poor telephone reception or interference with displays in the screens.

### USB port / Jack auxiliary socket

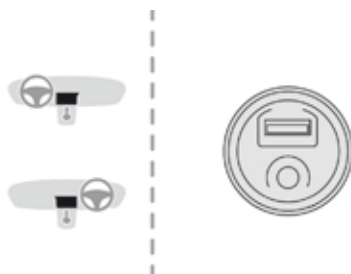

This connection box, consisting of an USB port and a JACK auxiliary socket is located on the centre console.

It allows the connection of portable device, such as a digital audio player of the iPod® type or a USB memory stick.

It reads the audio files which are transmitted to your audio system and played via the vehicle's speakers.

You can manage these files using the steering mounted controls or the audio system control panel and display them in the instrument panel screen.

When the USB port is used, the portable device charges automatically.

While charging, a message is displayed if the current drawn by the portable device exceeds the power rating of the vehicle's port.

**i** For more information on the use of this system, refer to the "Audio equipment and telematics" section.

## Boot fittings

1. Rear parcel shelf
2. Hooks
3. Boot lamp
4. Stowing rings (depending on version)

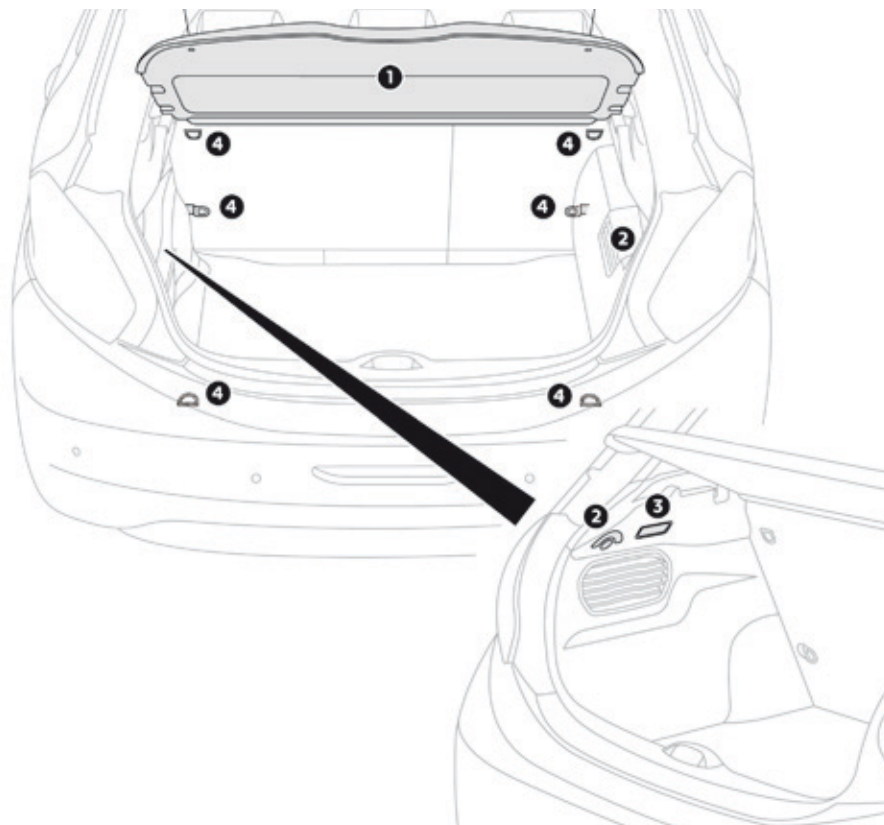

## Rear parcel shelf

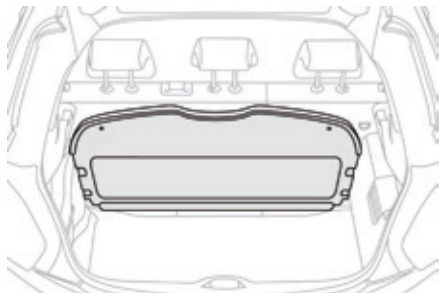

To remove the shelf:

- ☞ unhook the two cords,
- ☞ raise the shelf slightly, then remove it.

To stow it:

- vertically behind the rear seats,
- vertically behind the front seats.

To refit the shelf:

- ☞ engage it in the supports on each side and slide it up to the cut-outs,
- ☞ raise it to refit the two cords.

# Mirrors

## Door mirrors

**!** As a safety measure, the mirrors should be adjusted to reduce the blind spot.

### Manual

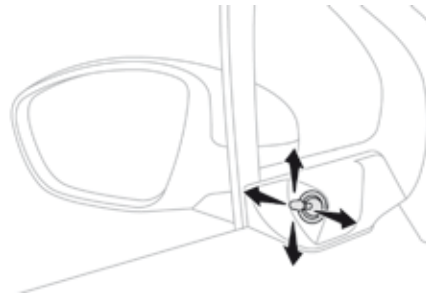

#### Adjustment

- ☞ Operate the lever in the four directions to adjust the angle of the mirror glass.

#### Folding

- ☞ Fold the mirror manually to protect it when the vehicle is parked.
  - ☞ Unfold it before moving off again.
- They do not have automatic heating.

### Electric



#### Adjustment

- ☞ Move control **A** to the right or to the left to select the corresponding mirror.
- ☞ Move control **B** in all four directions to adjust.
- ☞ Return control **A** to the central position.

#### Folding

- ☞ Control **A** in the central position, pull it back to fold the mirrors.
- ☞ Pull it again to unfold them.

## Using the remote control

### Adjustment

- ☞ Unlock the vehicle with the remote control to unfold the door mirrors.
- ☞ When locking the vehicle, the mirrors fold automatically.

**i** If the mirrors are folded using control **A**, they will not unfold when the vehicle is unlocked. It is necessary to press control **A** again.

**!** The objects observed are, in reality, closer than they appear. Take this into account in order to correctly judge the distance of vehicles approaching from behind.

**i** The automatic folding and unfolding of the rear view mirrors when using the remote control can be deactivated by a PEUGEOT dealer or a qualified workshop. Fold the mirrors when using an automatic car wash. If necessary, it is possible to fold the mirrors manually.

## Manual rear view mirror

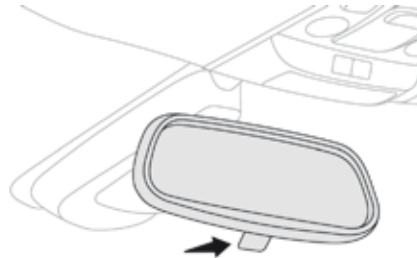

The rear view mirror has two positions:

- day (normal),
- night (anti-dazzle).

To change from one to the other, push or pull the lever on the lower edge of the mirror.

## Automatic rear view mirror

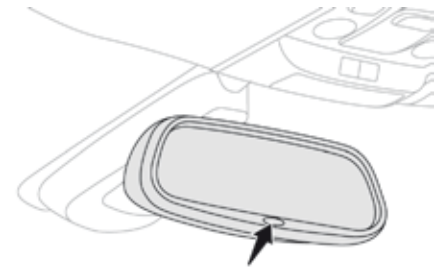

A sensor measuring the light from the rear of the vehicle, automatically and progressively adjusts the brightness of the mirror.

# Lighting

## Main lighting

The vehicle has various exterior lamps:

- sidelamps, to be seen,
- dipped beam headlamps to see without dazzling other drivers,
- main beam headlamps to see clearly when the road is clear.

## Additional lighting

Other lamps are fitted to meet particular driving conditions:

- a rear foglamp to better signal the presence of the vehicle in foggy conditions,
- front foglamps with cornering lighting,
- daytime running lamps to be seen during the day,
- guide-me-home and welcome lighting for leaving and entering the vehicle.

## Automatic lighting functions

Various automatic lighting functions are also available depending on options:

- guide-me-home lighting,
- cornering lighting,
- welcome lighting,
- daytime running lamps,
- automatic illumination of headlamps.

**i** In some weather conditions (e.g. low temperature or humidity), the presence of misting on the internal surface of the glass of the headlamps and rear lamps is normal; it disappears after the lamps have been on for a few minutes.

## Manual mode

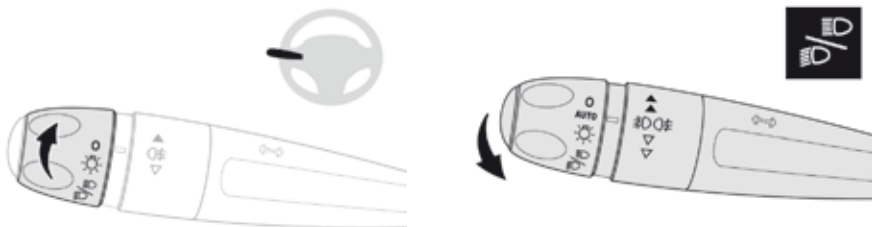

Place the desired symbol against the marking.

 Lighting off (ignition off) / Daytime running lamps (engine running).

 Sidelamps only.

 Dipped or main beam headlamps.

## Dipping the headlamps

Pull the stalk to switch the lighting between dipped / main beam headlamps.

In the lighting off and sidelamps modes, the driver can switch on the main beam headlamps temporarily ("headlamp flash") by maintaining a pull on the stalk.

## Display

Illumination of the corresponding indicator lamp in the instrument panel confirms the lighting switched on.



## AUTO AUTO mode

The sidelamps and dipped beam headlamps are switched on automatically, without any action on the part of the driver, when a low level of ambient light is detected or in certain cases of activation of the windscreen wipers.

As soon as the brightness returns to a sufficient level or after the windscreen wipers are switched off, the lamps are switched off automatically.

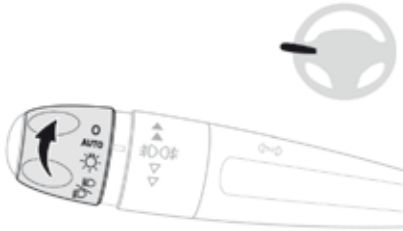

### On

- ☞ Turn the ring to the "AUTO" position. Activation of the function is accompanied by a message in the screen.

### Off

- ☞ Turn the ring to another position. Deactivation of the function is accompanied by a message in the screen.

## Automatic guide-me-home lighting

Association with the automatic lighting provides the guide-me-home lighting with the following additional options:

- selection of the lighting duration of 15, 30 or 60 seconds,
- automatic activation of guide-me-home lighting when the automatic illumination of headlamps is in operation.

## Configuration

### Switching on

#### MENU

Press "MENU" to display the "MAIN MENU".



Select "Driving".



Select "Secondary page".



Select "Vehicle settings".



Select the "Driving assistance" tab.



Activate the "Guide me home" function.

### Switching off



Deactivate the "Guide me home" function.

### SERVICE

In the event of a fault with the sunshine sensor, the lighting comes on, this warning lamp is displayed in the instrument panel and/or a message appears in the screen, accompanied by an audible signal. Contact a PEUGEOT dealer or a qualified workshop.



In fog or snow, the sunshine sensor may detect sufficient light. In this case, the lighting will not come on automatically.

Do not cover the sunshine sensor, coupled with the rain sensor and located in the centre of the windscreen behind the rear view mirror; the associated functions would no longer be controlled.

## Manual guide-me-home lighting

Temporarily keeping the dipped beam headlamps on after the vehicle's ignition has been switched off makes the driver's exit easier when the light is poor.

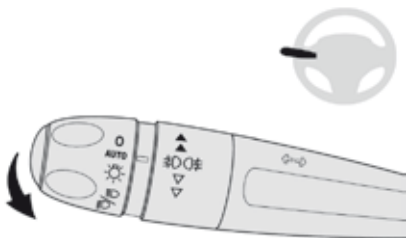

### On

- ☞ With the ignition off, "flash" the headlamps using the lighting stalk.
- ☞ A further "headlamp flash" switches the function off.



Manual guide-me-home lighting is also available from the remote control lighting button (refer to the corresponding section).

### Off

The manual guide-me-home lighting switches off automatically after a set time.

## Parking lamps



Side markers for the vehicle by illumination of the sidelamps on the traffic side only.

- ☞ Within one minute of switching off the ignition, operate the lighting control stalk up or down depending on the traffic side (for example: when parking on the left; lighting control stalk upwards; the right hand sidelamps are on).

This is confirmed by an audible signal and illumination of the corresponding direction indicator warning lamp in the instrument panel. To switch off the parking lamps, return the lighting control stalk to the middle position or switch on the ignition.

## Foglamps

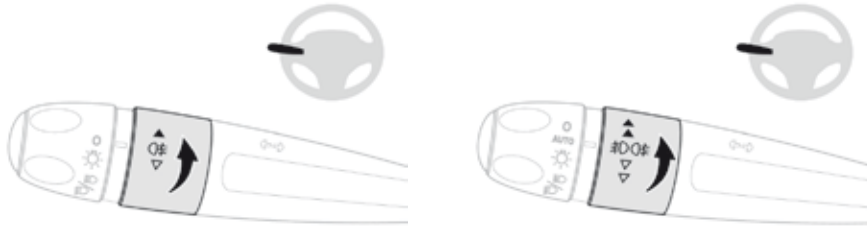

The foglamps operate with dipped or main beam headlamps on.



### Rear fog lamp only

- ☞ To switch it on, turn the ring forwards.
- When the lighting is switched off automatically (with AUTO model), the foglamp and the dipped beam headlamps will remain on.
- ☞ To switch it off, turn the ring rearwards.



### Front foglamps and rear fog lamp

- Rotate and release the ring:
- ☞ forwards a first time to switch on the front foglamps,
  - ☞ forwards a second time to switch on the rear foglamp,
  - ☞ rearwards a first time to switch off the rear foglamp,
  - ☞ rearwards a second time to switch of the front fog lamps.

When the headlamps switch off with automatic illumination of headlamps (AUTO model) or when the dipped beam headlamps are switched off manually, the foglamps and sidelamps remain on.

- ☞ Turn the ring rearwards to switch off the foglamps, the sidelamps will then switch off.

**!** In good or rainy weather, both day and night, the front foglamps and the rear foglamp are prohibited. In these situations, the power of their beams may dazzle other drivers. They should only be used in fog or snow. In these weather conditions, it is your responsibility to switch on the foglamps and dipped beam headlamps manually as the sunshine sensor may detect sufficient light. Do not forget to switch off the front foglamps and the rear foglamp when they are no longer necessary.

**i** **Switching off the lamps when the ignition is switched off**

On switching off the ignition, all of the lamps turn off immediately, except for dipped beam if guide-me-home lighting is activated.

**i** **Switching on the lamps after the ignition is switched off**

To reactivate the lighting control, rotate the ring to the "0" position - lamps off, then to the desired position.

On opening the driver's door a temporary audible signal warns the driver that the lighting is on.

The lamps, with the exception of the sidelamps, switch off automatically after a maximum duration of 30 minutes to avoid discharging the battery.

## LED lamps

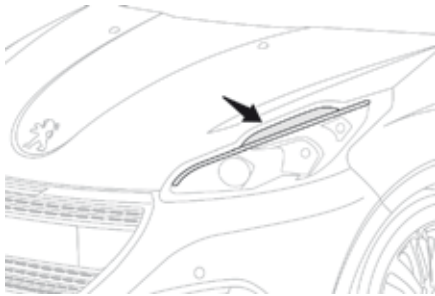

They come on when the engine is started. Depending on the country of sale, they are used for:

- daytime running lamps\* in day mode and sidelamps in night mode (they are brighter when daytime running lamps),
- or
- sidelamps in day and night mode.

\* Function that can be set in the vehicle configuration menu.

## Daytime running lamps

Daytime lighting, compulsory in certain countries, which comes on automatically when the engine is started making the vehicle more visible to other users.

This function is assured:

- in countries where it is imposed by regulations, by illumination of the dipped beam headlamps with the sidelamps and number plate lamps; this function cannot be deactivated.
- for other countries where it is provided, by the use of dedicated lamps (bulbs or LEDs); this function can be activated or deactivated via the vehicle configuration menu.

The lighting control stalk must be placed in the "0" or "AUTO" (day mode) position. Deactivation of the daytime running lamps is effective after operation of the lighting control stalk or after the next engine start; activation is effective immediately.

The instruments and controls (instrument panel, multifunction screen, air conditioning control panel, ...) are not illuminated, except in night mode with manual or automatic illumination of headlamps.

## Direction indicators

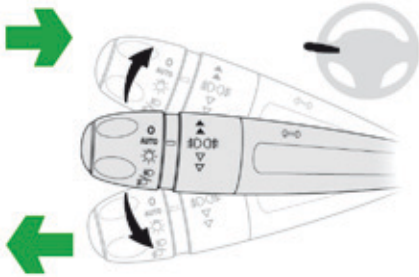

- ☞ Lower the lighting control stalk fully when moving to the left.
- ☞ Raise the lighting control stalk fully when moving to the right.

**i** If you forget to cancel the direction indicators for more than 20 seconds, the volume of the audible signal will increase if the speed is above 40 mph (60 km/h).

### Three flashes

Move the stalk briefly upwards or downwards, without going beyond the point of resistance; the corresponding direction indicators will flash 3 times.

**i** This function can be used at any speed, but it is particularly useful for changing lane on fast roads.

## Headlamp adjustment

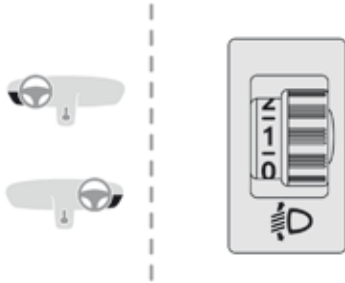

To avoid causing a nuisance to other road users, the headlamp beams should be adjusted according to the load in the vehicle.

**0.** 1 or 2 people in the front seats.

- Intermediate setting

**1.** 5 people.

- 5 people + maximum authorised load.

**2.** Driver + maximum authorised load.

### **i** Travelling abroad

If using your vehicle in a country that drives on the other side of the road, the headlamps must be adjusted to avoid dazzling on-coming drivers. Contact a PEUGEOT dealer or a qualified workshop.

**i** The initial setting is position "0".

## Cornering lighting

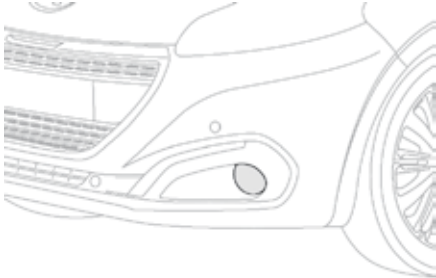

With the dipped or main beam headlamps on, this function makes use of the beam from the front foglamp to illuminate the inside of a bend, when the vehicle speed is below 25 mph (approximately 40 km/h) (urban driving, winding road, intersections, parking manoeuvres...).

### Programming



The system is activated or deactivated in the vehicle configuration menu.

The system is activated by default.

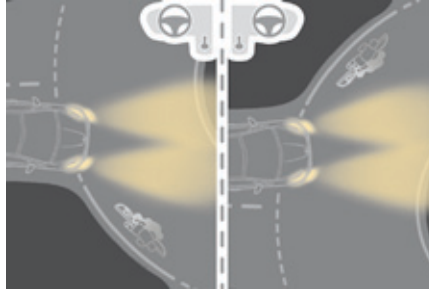

Without cornering lighting

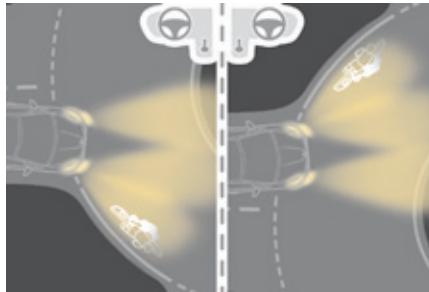

With cornering lighting

### Activation

The system operates:

- when the corresponding direction indicator is switched on,

or

- from a certain angle of rotation of the steering wheel.

### Deactivation

The system does not operate:

- below a certain angle of rotation of the steering wheel,
- above 25 mph (40 km/h),
- when reverse gear is engaged.



# Wipers

## Front

### Manual mode

The wipers are controlled directly by the driver.

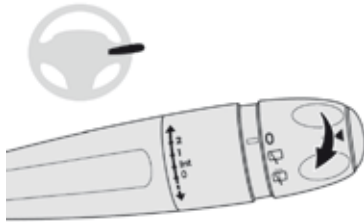

### Wipe

**2** Fast (heavy rain).

**1** Normal (moderate rain).

**Int** Intermittent (proportional to the speed of the vehicle).

**0** Park.

**↓** Single wipe (press down and release).

### AUTO mode

#### AUTO

The windscreen wipers operate automatically, without any action on the part of the driver, when rain is detected (sensor behind the rear view mirror), adapting their speed to the intensity of the rainfall.

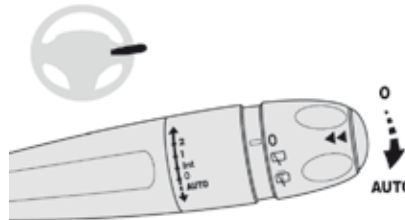

### Switching on

Briefly push the control stalk downwards. A wiping cycle confirms that the instruction has been accepted.



This warning lamp comes on in the instrument panel and a message is displayed.

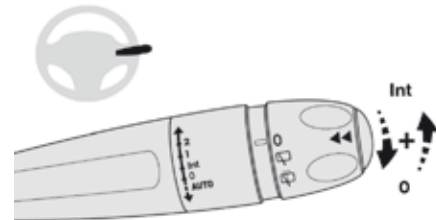

### Switching off

Briefly push the control stalk downwards again, or place the control stalk in another position (Int, 1 or 2).



This warning lamp goes off in the instrument panel and a message is displayed.

## Single wipe

Pull the stalk briefly towards you.

**i** The automatic rain sensitive windscreen wipers must be reactivated by pushing the control stalk downwards, if the ignition has been off for more than 1 minute.

## Unusual operation

If the wipers operate in intermittent mode when in AUTO mode, have the system checked by a PEUGEOT dealer or a qualified workshop.

**!** Do not cover the rain sensor, linked with the sunshine sensor, located at the top of the windscreen behind the rear view mirror.  
Switch off the automatic rain sensitive wipers when using an automatic car wash. In winter, it is advisable to wait until the windscreen is completely clear of ice before activating the automatic rain sensitive wipers.

## Rear

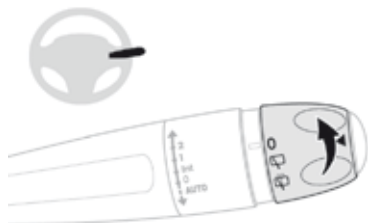

Park.



Intermittent wipe.



Wash-wipe (set duration).

**!** If a significant accumulation of snow or ice is present, or when using a bicycle carrier on the boot, deactivate the automatic rear wiper via the vehicle configuration menu.

## Reverse gear

When reverse gear is engaged, the rear wiper will come into operation if the windscreen wipers are operating.

## Configuration

On



Press "MENU" to display the "MAIN MENU".



Select "Driving".



Select "Secondary page".



Select "Vehicle settings".



Select the "Driving assistance" tab.



Activate the "Auto rear wiper in reverse" function.

This function is activated by default.

Off

Deactivate the "Auto rear wiper in reverse" function.

## Windscreen wash

Pull the wiper stalk towards you. The windscreen wash, then the windscreen wipers, operate for a pre-determined time.



### Advice

## Screenwash reservoir

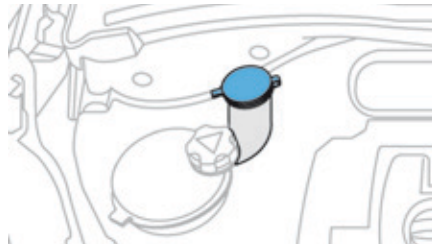

Top-up the level when necessary.

- ☞ Open the bonnet and secure it with the stay.
- ☞ Identify the reservoir filler cap.
- ☞ Open the blue filler cap.
- ☞ Pour in screenwash fluid for optimum cleaning.

## Fluid specification

For optimum cleaning and to avoid freezing, this fluid must not be topped-up or replaced with plain water.

In wintry conditions, it is recommended that you use an ethyl alcohol or methanol based fluid.

## Hazard warning lamps

Visual warning with of all the direction indicators flashing to alert other road users to a vehicle breakdown, towing or accident.



☞ Press this button, all of the direction indicators flash.

They can operate with the ignition off.

### Automatic operation

When braking in an emergency, depending on the deceleration, the lamps come on automatically.

They switch off automatically the first time you accelerate.

☞ You can also switch them off by pressing the button.

## Roadholding

Electronic Stability Control (ESC) comprising the following systems:

- anti-lock braking system (ABS) and electronic brake force distribution (EBFD),
- emergency braking assistance,
- wheel anti-slip regulation (ASR) or traction control,
- dynamic stability control (DSC).

### Anti-lock braking system (ABS) and electronic brake force distribution (EBFD)

These systems improve the stability and manoeuvrability of your vehicle when braking and contribute towards improved control in corners, in particular on poor or slippery road surfaces.

The ABS prevents wheel lock in the event of emergency braking.

The electronic brake force distribution system manages the braking pressure wheel by wheel.

### Emergency braking assistance

In an emergency, this system enables you to reach the optimum braking pressure more quickly and therefore reduce the stopping distance.

It is triggered in relation to the speed at which the brake pedal is pressed. This is felt by a reduction in the resistance of the pedal and an increase in the effectiveness of the braking.

### Anti-slip regulation (ASR)

This system (also known as Traction Control) optimises traction in order to avoid wheel slip by acting on the brakes of the driving wheels and on the engine. It also improves the directional stability of the vehicle on acceleration.

### Dynamic stability control (DSC)

If there is a difference between the path followed by the vehicle and that required by the driver, this system monitors each wheel and automatically acts on the brake of one or more wheels and on the engine to return the vehicle to the required path, within the limits of the laws of physics.

## Anti-lock braking system (ABS) and electronic brake force distribution (EBFD)



The fixed illumination of this warning lamp indicates that there is a fault with the ABS.

The vehicle retains conventional braking. Drive carefully at moderate speed.



When this warning lamp comes on, coupled with the **STOP** and ABS warning lamps, accompanied by an audible signal and a message, it indicates that there is a fault with the electronic brake force distribution (EBFD).

**You must stop as soon as it is safe to do so.**

In both cases, have the system checked by a PEUGEOT dealer or a qualified workshop as soon as possible.



When changing wheels (tyres and rims), ensure that these are approved for your vehicle.

Normal operation of the ABS may make itself felt by slight vibrations of the brake pedal.



**In emergency braking, press very firmly and maintain this pressure.**

## Dynamic stability control (DSC) and anti-slip regulation (ASR)



These systems are activated automatically every time the vehicle is started.



The operation of the dynamic grip or trajectory control system is signalled by flashing of the warning lamp in the instrument panel, every time they are brought into play.

## Limits of operation

In exceptional conditions (starting a vehicle which is bogged down, stuck in snow, on soft ground...), it may be advisable to deactivate the DSC system, so that the wheels can spin freely and regain grip.

However, it is recommended that the system be reactivated as soon as possible.



- ☞ Pressing switches off the DSC system, the indicator lamp in the button comes on. You can then spin the wheels to regain grip.



- ☞ Pressing again switches the system back on.



### Advice

The DSC system is switched on automatically every time the engine is started or after reaching a speed of 30 mph (50 km/h). Except for the 1.6 litre THP 155, THP 200 and THP 208 engines, where the button has to be pressed; the indicator lamp in the button stays off.



#### Fixed illumination

The DSC/ASR system has a fault. Have the system checked by a PEUGEOT dealer or a qualified workshop.



The DSC system offers exceptional safety in normal driving, but this should not encourage the driver to take extra risks or drive at high speed. The correct operation of the system depends on observation of the manufacturer's recommendations regarding the wheels (tyres and rims), the braking components, the electronic components and the PEUGEOT assembly and repair procedures. After an impact, have the system checked by a PEUGEOT dealer or a qualified workshop.

## Seat belts

### At the front



The front seat belts are fitted with a pretensioning and force limiting system. This system improves safety in the front seats in the event of a front or side impact. Depending on the severity of the impact, the pretensioning system instantly tightens the seat belts against the body of the occupants. The pretensioning seat belts are active when the ignition is on. The force limiter reduces the pressure of the seat belt on the chest of the occupant, so improving their protection.

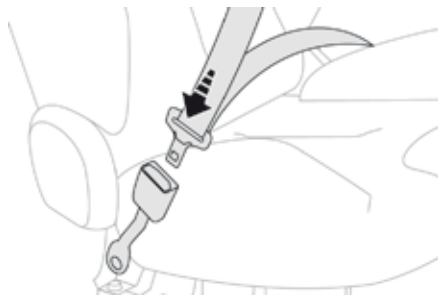

#### Fastening

- ☞ Pull the strap, then insert the tongue in the buckle.
- ☞ Check that the seat belt is fastened correctly by pulling the strap.

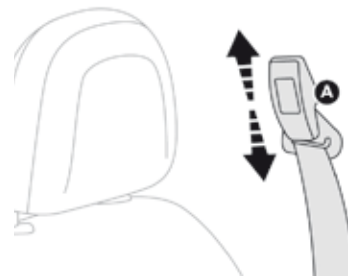

#### Height adjustment (5-door)

- ☞ To lower the attachment point, squeeze the control **A** and slide it downwards.
- ☞ To raise the attachment point, slide the control **A** upwards.

#### Unfastening

- ☞ Press the red button on the buckle.
- ☞ Guide the seat belt as it reels in.

## Warning lamp



Not fastened / unfastened.

This warning lamp comes on in the instrument panel when the ignition is switched on.

It remains on for a certain time if the front passenger has not fastened their seat belt. Once this period has elapsed, the warning lamp goes off if the driver's seat belt is fastened. From approximately 12 mph (20 km/h) this warning lamp flashes for 2 minutes accompanied by an audible signal of increasing volume. Once these 2 minutes have elapsed, this warning lamp remains on until the driver and/or the front passenger fastens their seat belt.

## At the rear

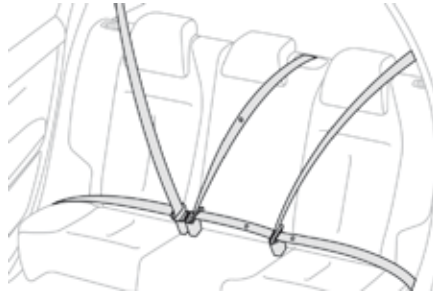

The rear seats are each fitted with a three-point seat belt, with force limiter and, for the outer seats, an effort limiter.

### Fastening

- ☞ Pull the strap, then insert the tongue in the buckle.
- ☞ Check that the seat belt is fastened correctly by pulling the strap.

### Unfastening

- ☞ Press the red button on the buckle.
- ☞ Guide the seat belt as it reels in.
- ☞ On the outer seat belts, raise the bar to the top of the backrest to prevent the tongue from knocking against the side trim.

### Warning lamp



Unfastened.

From approximately 12 mph (20 km/h) and for 2 minutes, this warning lamp flashes, accompanied by an audible signal of increasing volume, when one or more rear passengers unfasten their seat belt.

Once these two minutes have elapsed, this warning lamp remains on until the one or more rear passengers fasten their seat belt.



## i Advice

The driver must ensure that passengers use the seat belts correctly and that they are all fastened before setting off.

Wherever you are seated in the vehicle, always fasten your seat belt, even for short journeys.

Do not interchange the seat belt buckles as they will not fulfil their role fully.

The seat belts are fitted with an inertia reel permitting automatic adjustment of the length of the strap to your size. The seat belt is stowed automatically when not in use.

Before and after use, ensure that the seat belt is reeled in correctly.

The lower part of the strap must be positioned as low as possible on the pelvis.

The upper part must be positioned in the hollow of the shoulder.

The inertia reels are fitted with an automatic locking device which comes into operation in the event of a collision, emergency braking or if the vehicle rolls over. You can release the device by pulling the strap firmly and then releasing it so that it reels in slightly.

In order to be effective, a seat belt must:

- be tightened as close to the body as possible,
- be pulled in front of you with a smooth movement, checking that it does not twist,
- be used to restrain only one person,
- not bear any trace of cuts or fraying,
- not be converted or modified to avoid affecting its performance.

In accordance with current safety regulations, for all repairs on your vehicle's seat belts, go to a qualified workshop with the skills and equipment needed, which a PEUGEOT dealer is able to provide. Have your seat belts checked regularly by a PEUGEOT dealer or a qualified workshop, particularly if the straps show signs of damage.

Clean the seat belt straps with soapy water or a textile cleaning product, sold by PEUGEOT dealers.

After folding or moving a seat or rear bench seat, ensure that the seat belt is positioned and reeled in correctly.

## Recommendations for children

Use a suitable child seat if the passenger is less than 12 years old or shorter than one and a half metres.

Never use the same seat belt to secure more than one person.

Never allow a child to travel on your lap.

For more information on child seats, refer to the corresponding section.

## In the event of an impact

**Depending on the nature and seriousness of the impact**, the pretensioning device may be deployed before and independently of the airbags. Deployment of the pretensioners is accompanied by a slight discharge of harmless smoke and a noise, due to the activation of the pyrotechnic cartridge incorporated in the system.

In all cases, the airbag warning lamp comes on.

Following an impact, have the seat belts system checked, and if necessary replaced, by a PEUGEOT dealer or a qualified workshop.

# Airbags

## General information

System designed to contribute towards improving the safety of the occupants (with the exception of the rear centre passenger) in the event of violent collisions. The airbags supplement the action of the seat belts fitted with force limiters (all except the centre rear passenger belt).

If a collision occurs, the electronic detectors record and analyse the front and side impacts sustained in the impact detection zones:

- in the case of a serious impact, the airbags are deployed instantly and contribute towards better protection of the occupants of the vehicle (with the exception of the rear centre passenger); immediately after the impact, the airbags deflate rapidly so that they do not hinder visibility or the exit of the occupants,
- in the case of a minor or rear impact or in certain roll-over conditions, the airbags may not be deployed; the seat belt alone contributes towards ensuring your protection in these situations.

**!** **The airbags do not operate when the ignition is switched off.**

This equipment will only deploy once. If a second impact occurs (during the same or a subsequent accident), the airbag will not be deployed again.

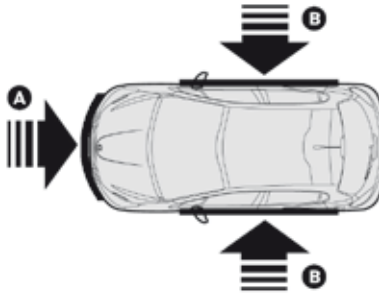

## Impact detection zones

- A. Front impact zone.
- B. Side impact zone.

**i** Deployment of one or more of the airbags is accompanied by a slight emission of smoke and a noise, due to the activation of the pyrotechnic cartridge incorporated in the system. This smoke is not harmful, but sensitive individuals may experience slight irritation. The noise of detonation associated with the deployment of one or more airbags may result in a slight loss of hearing for a short time.

## Front airbags

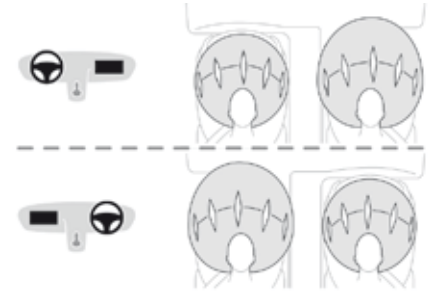

System which protects the driver and front passenger in the event of a serious front impact, in order to limit the risk of injury to the head and thorax.

The driver's airbag is fitted in the centre of the steering wheel; the front passenger's airbag is fitted in the dashboard above the glove box.

## Deployment

The airbags are deployed, except the passenger's front airbag if it has been deactivated, in the event of a serious front impact to all or part of the front impact zone A, in the longitudinal centreline of the vehicle on a horizontal plane and directed from the front to the rear of the vehicle.

The front airbag inflates between the thorax and head of the front occupant of the vehicle and the steering wheel, driver's side, and the dashboard, passenger's side to cushion their forward movement.

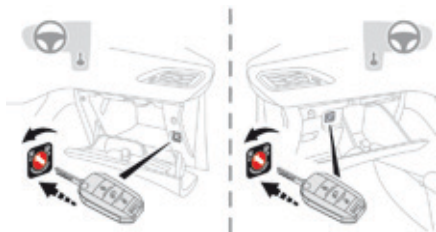

## Deactivation

Only the passenger's front airbag can be deactivated.

- ☞ **With the ignition off**, insert the key into the passenger airbag deactivation switch.
- ☞ Turn it to the **"OFF"** position,
- ☞ Remove the key keeping the switch in the new position.



When the ignition is on, this warning lamp comes on in the instrument panel while the airbag is deactivated.



To assure your child's safety, you must deactivate the passenger's front airbag when you install a rearward facing child seat on the front passenger seat. Otherwise, the child risks being seriously injured or killed if the airbag is deployed.

## Reactivation

When you remove the rearward facing child seat, **with the ignition on**, turn the switch to the **"ON"** position to reactivate the airbag and so assure the safety of your front passenger in the event of an impact.

## Operating fault



If this warning lamp comes on in the instrument panel, you must contact a PEUGEOT dealer or a qualified workshop without delay to have the system checked. The airbags may no longer be deployed in the event of a serious impact.

## Lateral airbags

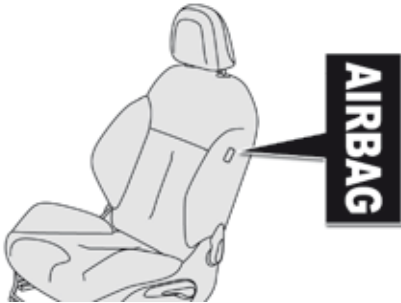

System which protects the driver and front passenger in the event of a serious side impact in order to limit the risk of injury to the chest, between the hip and the shoulder. Each lateral airbag is fitted in the seat backrest frame, door side.

### Deployment

A lateral airbag is deployed unilaterally in the event of a serious side impact applied to all or part of the side impact zone **B**, perpendicular to the longitudinal centreline of the vehicle on a horizontal plane and directed from the outside towards the inside of the vehicle.

The lateral airbag inflates between the hip and shoulder of the front occupant of the vehicle and the corresponding door trim panel.

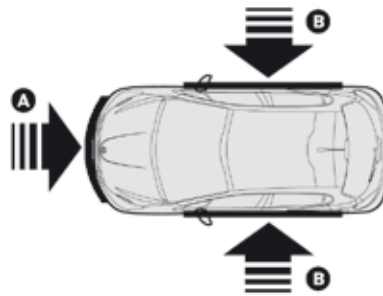

### Impact detection zones

- A. Front impact zone.
- B. Side impact zone.

## Curtain airbags

System which contributes towards improving the protection of the driver and passengers (with the exception of the rear centre passenger) in the event of a serious side impact in order to limit the risk of injury to the side of the head.

Each curtain airbag is built into the pillars and the upper passenger compartment area.

### Deployment

The curtain airbag is deployed at the same time as the corresponding lateral airbag in the event of a serious side impact applied to all or part of the side impact zone **B**, perpendicular to the longitudinal centreline of the vehicle on a horizontal plane and directed from the outside towards the inside of the vehicle.

The curtain airbag inflates between the front or rear occupant of the vehicle and the windows.

### Operating fault



If this warning lamp comes on in the instrument panel, you must contact a PEUGEOT dealer or a qualified workshop to have the system checked. The airbags may no longer be deployed in the event of a serious impact.



In the event of a minor impact or bump on the side of the vehicle or if the vehicle rolls over, the airbag may not be deployed.

In the event of a rear or front collision, the airbag is not deployed.

## ! Advice

Sit in a normal upright position.

Wear a correctly adjusted seat belt.

Do not allow anything to come between the occupants and the airbags (a child, pet, object...), do not attach or fix anything near to the airbags or their trajectories when inflating as this could cause injuries when the airbags are deployed.

Never modify the original definition of your vehicle, particularly in the area directly around the airbags.

After an accident or if the vehicle has been stolen or broken into, have the airbag systems checked.

All work on the airbag system must be carried out by a PEUGEOT dealer or a qualified workshop.

Even if all of the precautions mentioned are observed, a risk of injury or of minor burns to the head, chest or arms when an airbag is deployed cannot be ruled out. The bag inflates almost instantly (within a few milliseconds) then deflates within the same time discharging the hot gas via openings provided for this purpose.

## Front airbags

Do not drive holding the steering wheel by its spokes or resting your hands on the centre part of the wheel.

Passengers must not place their feet on the dashboard.

Do not smoke as deployment of the airbags can cause burns or the risk of injury from a cigarette or pipe.

Never remove or pierce the steering wheel or hit it violently.

Do not fit or attach anything to the steering wheel or dashboard, this could cause injuries with deployment of the airbags.

## Lateral airbags

Use only approved covers on the seats, compatible with the deployment the lateral airbags. For information on the range of seat covers suitable for your vehicle, you can contact a PEUGEOT dealer.

For more information on accessories, refer to the corresponding section.

Do not fix or attach anything to the seat backs (clothing...). This could cause injury to the chest or arms if the lateral airbag is deployed.

Do not sit with the upper part of the body any nearer to the door than necessary.

## Curtain airbags

Do not fix or attach anything to the roof. This could cause injury to the head if the curtain airbag is deployed.

If fitted on your vehicle, do not remove the grab handles installed on the roof, they play a part in securing the curtain airbags.

# Carrying children

## General points

Although one of PEUGEOT's main criteria when designing your vehicle, the safety of your children also depends on you.

For maximum safety, please observe the following recommendations:

- in accordance with European regulations, **all children under the age of 12 or less than one and a half metres tall must travel in approved child seats suited to their weight**, on seats fitted with a seat belt or ISOFIX mountings\*,
- **statistically, the safest seats in your vehicle for carrying children are the rear seats**,
- **a child weighing less than 9 kg must travel in the rearward facing position both in the front and in the rear.**

- i** **PEUGEOT recommends** that children should travel in the **outer rear seats** of your vehicle:
  - **rearward facing** up to the age of 3,
  - **forward facing** over the age of 3.

\* The regulations on carrying children are specific to each country. Refer to the legislation in force in your country.

## At the front\*



### Rearward facing

When a rearward facing child seat is installed on the **front passenger seat**, adjust the seat to the fully back and highest position, with the backrest straightened.

The passenger airbag must be deactivated.

Otherwise, **the child would risk being seriously injured or killed if the airbag were to inflate.**

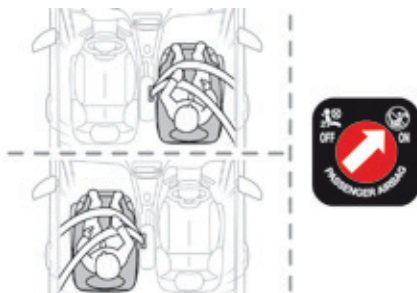

### Forward facing

When a forward facing child seat is installed on the **front passenger seat**, adjust the vehicle's seat to the fully back and highest position with seat backrest straightened and leave the passenger's airbag activated.

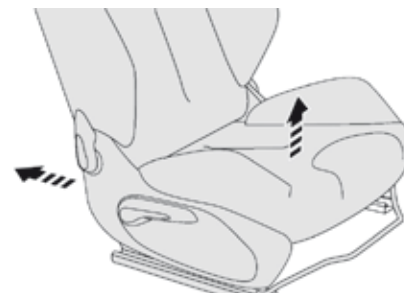

### Passenger seat

#### Adjustment

- In the fully back position.
- Seat cushion in the high position.

**i** Ensure that the seat belt is correctly tensioned.  
Ensure that the child seat is not in contact with a part of the vehicle other than the passenger seat.

\* Consult the legislation in force in your country before installing your child on this seat.

## Deactivating the passenger's front airbag

**!** Never install a rearward facing child restraint system on a seat protected by an active front airbag. This could cause the death of the child or serious injury.



The warning label present on both sides of the passenger's sun visor repeats this advice. In line with current legislation, the following tables contain this warning in all of the languages required.

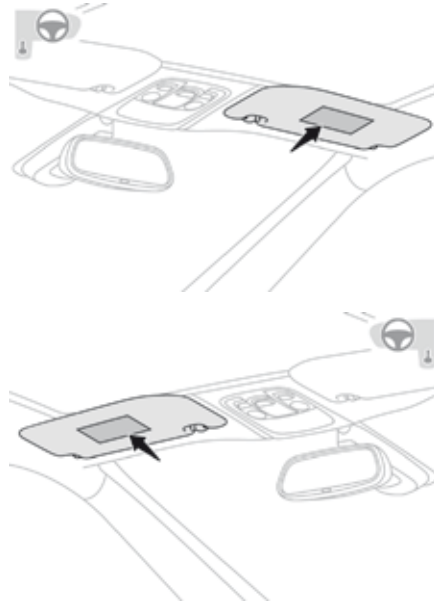

## Passenger airbag OFF

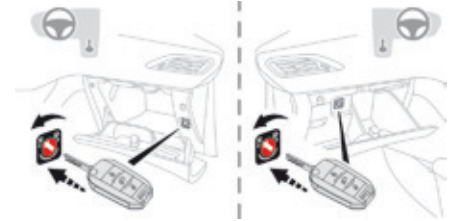

Only the passenger's front airbag can be deactivated.

- ☞ With the ignition off, introduce the key into the passenger airbag deactivation switch.
- ☞ Turn it to the "OFF" position.
- ☞ Remove the key, leaving the switch in this position.



When the ignition is on, this warning lamp comes on in the instrument panel and stays on while the airbag is deactivated.



AR	لا يجب أبدا تركيب نظام لإجلاس الطفل الوجه باتجاه الورا على مقعد سيارة مجهز بوسادة امان هوائية امامية مغلقة، فقد يؤدي هذا إلى التسبب بموت الطفل أو بإصابات خطيرة لديه.
BG	НИКОГА НЕ инсталирайте детско столче на седалка с АКТИВИРАНА предна ВЪЗДУШНА ВЪЗГЛАВНИЦА. Това може да причини СМЪРТ или СЕРИОЗНО НАРАНЯВАНЕ на детето.
CS	NIKDY neumisťujte dětské zádržné zařízení orientované směrem dozadu na sedadlo chráněné AKTIVOVANÝM čelním AIRBAGEM. Hrozí nebezpečí SMRTI DÍTĚTE nebo VAŽNĚHO ZRANĚNÍ.
DA	Brug ALDRIG en bagudvendt barnestol på et sæde, der er beskyttet af en AKTIV AIRBAG. BARNET risikerer at blive ALVORLIGT KVÆSTET eller DRÆBT.
DE	Montieren Sie auf einem Sitz mit AKTIVIERTEM Front-Airbag NIEMALS einen Kindersitz oder eine Babyschale entgegen der Fahrtrichtung, das Kind könnte schwere oder sogar tödliche Verletzungen erleiden.
EL	Μη χρησιμοποιείτε ΠΟΤΕ παιδικό κάθισμα με την πλάτη του προς το εμπρός μέρος του αυτοκινήτου, σε μια θέση που προστατεύεται από ΜΕΤΩΠΙΚΟ αερόσακο που είναι ΕΝΕΡΓΟΣ. Αυτό μπορεί να έχει σαν συνέπεια το ΘΑΝΑΤΟ ή το ΣΟΒΑΡΟ ΤΡΑΥΜΑΤΙΣΜΟ του ΠΑΙΔΙΟΥ
EN	NEVER use a rearward facing child restraint on a seat protected by an ACTIVE AIRBAG in front of it, DEATH or SERIOUS INJURY to the CHILD can occur
ES	NO INSTALAR NUNCA un sistema de retención para niños de espaldas al sentido de la marcha en un asiento protegido mediante un AIRBAG frontal ACTIVADO, ya que podría causar lesiones GRAVES o incluso la MUERTE del niño.
ET	Ärge MITTE KUNAGI paigaldage "seljaga sõidusuunas" lapseistet juhi kõrvalistmele, mille ESITURVAPADI on AKTIVEERITUD. Turvapadja avanemine võib last TÕSISELT või ELUOHTLIKULT vigastada.
FI	ÄLÄ KOSKAAN aseta lapsen turvaistuinta selkää ajosuuntaan istuimelle, jonka edessä suojana on käyttöön aktivoitu TURVATYÖNY. Sen laukeaminen voi aiheuttaa LAPSEN KUOLEMAN tai VAKAVAN LOUKKAANTUMISEN.
FR	NE JAMAIS installer de système de retenue pour enfants faisant face vers l'arrière sur un siège protégé par un COUSSIN GONFLABLE frontal ACTIFÉ. Cela peut provoquer la MORT de l'ENFANT ou le BLESSER GRAVEMENT
HR	NIKADA ne postavljati dječju sjedalicu leđima u smjeru vožnje na sjedalo zaštićeno UKLJUČENIM prednjim ZRAČNIM JASTUKOM. To bi moglo uzrokovati SMRT ili TEŠKU OZLJEDU djeteta.
HU	SOHA ne használjon menetiránynak háttal beszerelt gyermekülést AKTIVÁLT (BEKAPCSOLT) FRONTLÉGSZÁKKAL védett ülésen. Ez a gyermek HALÁLÁT vagy SÜLYÖS SÉRÜLÉSÉT okozhatja.
IT	NON installare MAI seggiolini per bambini posizionati in senso contrario a quello di marcia su un sedile protetto da un AIRBAG frontale ATTIVATO. Ciò potrebbe provocare la MORTE o FERITE GRAVI al bambino.
LT	NIEKADA neirenkite vaiko pilaikymo priemonės su atgal atgrežtu vaiku ant sėdynės, kuri saugoma VEIKIANČIOS priekinės ORO PAGALVĖS. Išsiskleidus oro pagalvei vaikas gali būti MIRTINAI arba SUNKIAI TRAUMUOTAS.
LV	NEKAD NEuzstādiēt uz aizmuguri vērstu bērnu sēdekļi priekšējā pasažiera sēdvietā, kurā ir AKTIVIZĒTS priekšējais DROŠĪBAS GAISA SPILVENS. Tas var izraisīt BĒRNA NĀVI vai radīt NOPIETNUS IEVAINOJUMUS.

MT	Qatt m'ghandek thalli tifel/tifla marbut f'siggu dahru lejn l-Airbag attiva, ghalix tista' tikkawza korriment serju jew anke mewt lit-tifel/tifla
NL	Plaats NOOIT een kinderzitje met de rug in de rijrichting op een zitplaats waarvan de AIRBAG is INGESCHAKELD. Bij het afgaan van de airbag kan het KIND LEVENSGEVAARLIJK GEWOND RAKEN
NO	Installer ALDRI et barnesete med ryggen mot kjøreretningen i et sete som er beskyttet med en frontal AKTIVERT KOLLISJONSPUTE, BARNET risikerer å bli DREPT eller HARDT SKADET.
PL	NIGDY nie instalować fotelika dziecięcego w pozycji "tyłem do kierunku jazdy" na siedzeniu wyposażonym w CZOŁOWĄ PODUSZKĘ POWIETRZNAJ w stanie AKTYWNYM. Może to doprowadzić do ŚMIERCI DZIECKA lub spowodować u niego POWAŻNE OBRAŻENIA CIAŁA.
PT	NUNCA instale um sistema de retenção para crianças de costas para a estrada num banco protegido por um AIRBAG frontal ACTIVADO. Esta instalação poderá provocar FERIMENTOS GRAVES ou a MORTE da CRIANÇA.
RO	Nu instalati NICIODATA un sistem de retinere pentru copii, dispus cu spatele in directia de mers, pe un loc din vehicul protejat cu AIRBAG frontal ACTIVAT. Aceasta ar putea provoca MOARTEA COPILULUI sau RANIREA lui GRAVA.
RU	ВО ВСЕХ СЛУЧАЯХ ЗАПРЕЩАЕТСЯ использовать обращенное назад детское удерживающее устройство на сиденье, защищенном ФУНКЦИОНИРУЮЩЕЙ ПОДУШКОЙ БЕЗОПАСНОСТИ, установленной перед этим сиденьем. Это может привести к ГИБЕЛИ РЕБЕНКА или НАНЕСЕНИЮ ЕМУ СЕРЬЕЗНЫХ ТЕЛЕСНЫХ ПОВРЕЖДЕНИЙ
SK	NIKDY neinštalujte detské zádržné zariadenie orientované smerom dozadu na sedadlo chránené AKTIVOVANÝM čelným AIRBAGOM. Mohlo by dôjsť k SMRTELNÉMU alebo VÁŽNEMU PORANENIU DIEŤAŤA.
SL	NIKOLI ne nameščajte otroškega sedeža s hrbtom v smeri vožnje, če je VARNOSTNA BLAZINA pred sprednjim sopotnikovim sedežem AKTIVIRANA. Takšna namestitvev lahko povzroči SMRT OTROKA ali HUDE POŠKODBE.
SR	NIKADA ne koristite dečje sedište koje se okreće unazad na sedištu zaštićenim AKTIVNIM VAZDUŠNIM JASTUKOM ispred njega, jer mogu nastupiti SMRT ili OZBILJNA POVREDA DETETA.
SV	Passagerarkrockkudden fram MÅSTE vara avaktiverad om en bakåtvänd bilbarnstol installerad på denna plats. Annars riskerar barnet att DÖDAS eller SKADAS ALLVARLIGT.
TR	KESİNLİKLE HAVA YASTIĞI AKTİF olan ön koltuğa yüzü arkaya dönük bir çocuk koltuğu yerleştirmeyiniz. Bu ÇOCUĞUN ÖLMESİNE veya ÇOK AĞIR YARALANMASINA sebep olabilir.

## At the rear

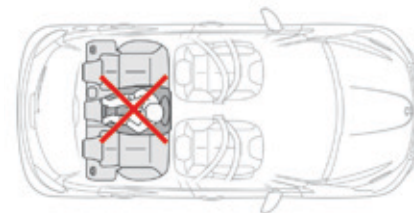
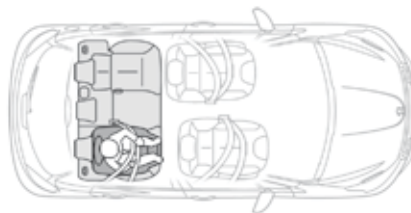
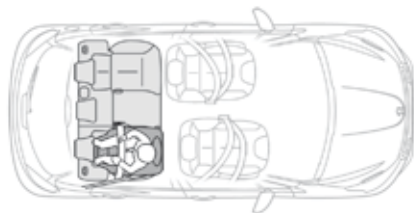

### Rearward facing

When a rearward facing child seat is installed **on a rear passenger seat**, move the vehicle's front seat forward and straighten the backrest so that the rearward facing child seat does not touch the vehicle's front seat.

- ! Remove and stow the head restraint before installing a child seat with backrest on a passenger seat. Refit the head restraint once the child seat has been removed.

### Forward facing

When a forward facing child seat is installed **on a rear passenger seat**, move the vehicle's front seat forward and straighten the backrest so that the legs of the child in the forward facing child seat do not touch the vehicle's front seat.

- ! Ensure that the seat belt is correctly tensioned. For child seats with a support leg, ensure that this is in firm contact with the floor. If necessary, adjust the front seat of the vehicle.

### Centre rear seat

A child seat with a support leg must never be installed on the **centre rear passenger seat**.

- ! The incorrect installation of a child seat in a vehicle compromises the protection of the child in the event of an accident.

## Secured by a 3-point seat belt

PEUGEOT offers a range of recommended child seats which are secured using a **three point seat belt**.

### Group 0+: from birth to 13 kg



#### L1

"RÖMER Baby-Safe Plus"  
Installed in the rearward facing position.

### Groups 2 and 3: from 15 to 36 kg



#### L4

"KLIPPAN Optima"  
From 22 kg (approximately 6 years), the booster is used on its own.







#### L5

"RÖMER KIDFIX"  
Can be fitted to the vehicle's ISOFIX mountings.  
The child is restrained by the seat belt.

## Locations for child seats

### Child seats secured with the seat belt

In accordance with the European regulation, this table indicates the options for the installation of child seats secured using the seat belt and universally approved (a) in relation to the weight of the child and the seat in the vehicle.

Weight of the child / indicative age					
Seat		Less than 13 kg (groups 0 (b) and 0+) Up to 1 year approx	From 9 to 18 kg (group 1) From 1 to 3 years approx	From 15 to 25 kg (group 2) From 3 to 6 years approx	From 22 to 36 kg (group 3) From 6 to 10 years approx
Front passenger seat (c), (e)					
					
- with height adjustment		<b>U(R)</b>	<b>U(R)</b>	<b>U(R)</b>	<b>U(R)</b>
- without height adjustment		<b>U*</b>	<b>U*</b>	<b>U*</b>	<b>U*</b>
Outer rear seats (d)		<b>U</b>	<b>U</b>	<b>U</b>	<b>U</b>
Centre rear seat (d)		<b>U (f)</b>	<b>U (f)</b>	<b>U</b>	<b>U</b>

**U:** seat suitable for the installation of a child seat secured using the seat belt and universally approved rearward facing and/or forward facing.

**U(R):** as for **U**, the vehicle seat must be adjusted to the highest and fully back position.

**U\*:** as for **U**, straightening the backrest.

- (a) universal child seat: child seat which can be installed in all vehicles using the seat belt.
- (b) group 0: from birth to 10 kg. Infant car seats and "car cots" cannot be installed on the front passenger seat.
- (c) consult the legislation in force in your country before installing your child on this seat.
- (d) to install a child seat on a rear seat, rearward or forward facing, move the front seat forward, then straighten the backrest to allow enough room for the child seat and the child's legs.
- (e) When a rearward facing child seat is installed on the front passenger seat, the passenger's airbag must be deactivated. Otherwise, the child risks being seriously injured or killed if the airbag is deployed. When a forward facing child seat is installed on the front passenger seat, the passenger's airbag must remain activate.
- (f) A child seat with support leg must never be installed on this passenger seat.

## "ISOFIX" mountings

Your vehicle has been approved in accordance with the **latest ISOFIX regulation**.

The seats, represented below, are fitted with regulation ISOFIX mountings:

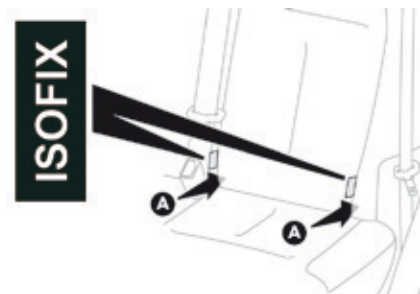
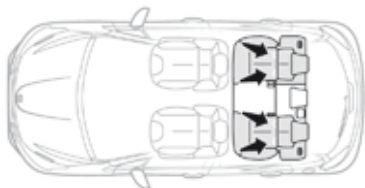

There are three rings for each seat:

- two rings **A**, hidden between the padding of vehicle seat backrest and cushion, directly below the "ISOFIX" label,

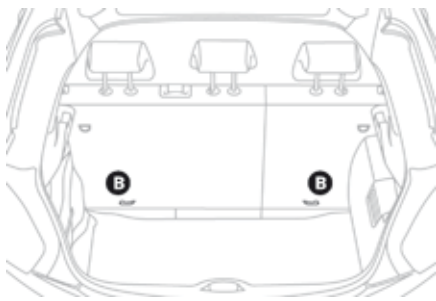

- a ring **B** behind the seat for fixing the upper strap, referred to as the **Top Tether**.

The Top Tether is used to secure the upper strap of child seats that have one. This arrangement limits the forward tipping of the child seat in the event of a front impact. This ISOFIX mounting system provides fast, reliable and safe fitting of the child seat in your vehicle.

When fitting an ISOFIX child seat to the left hand rear seat, before fitting the seat, first move the centre rear seat belt towards the middle of the vehicle, so as to avoid the seat interfering with the operation of the seat belt.

The **ISOFIX child seats** are fitted with two latches which are secured on the two rings **A**.

Some seats also have an **upper strap**, known as the Top Tether, which is attached to ring **B**.

To secure the child seat to the top tether:

- remove and stow the head restraint before installing the child seat in this seating position (refit it once the child seat has been removed),
- pass the upper strap of the child seat over the top of the seat backrest, centred between the apertures for the head restraint rods,
- fix the hook of the upper strap to the ring **B**,
- tighten the upper strap.

## Recommended seats

### "RÖMER Baby-Safe Plus and its Baby-Safe Plus ISOFIX base" (size category: E)

#### Group 0+: from birth to 13 kg



Installed rearward facing using an ISOFIX base which is attached to the rings **A**. The base has a support leg, adjustable for height, which sits on the vehicle's floor. This seat can be secured with a seat belt. In this case, only the shell is used and attached to the vehicle's seat by the three-point seat belt.

### Baby P2C Midi and its ISOFIX base (size categories: D, C, A, B, B1)

#### Group 1: from 9 to 18 kg

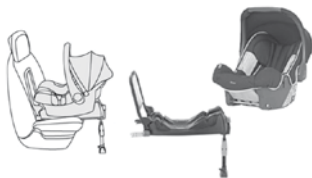

Installed rearward facing using an ISOFIX base which is attached to the rings **A**. The base has a support leg, adjustable for height, which sits on the vehicle's floor. This child seat can also be used forward facing. This seat can **not** be secured with a seat belt. We recommend that you use the seat in the rearward facing position up to the age of 3 years.

**i** Follow the instructions for fitting child seats contained in the seat manufacturer's installation guide.



**RÖMER Duo Plus ISOFIX (size category B1)****Group 1: from 9 to 18 kg**

Is installed in the forward facing position.  
 Is attached to the rings **A** and the upper ring **B**, referred to as the Top Tether, using an upper strap.  
 Three seat body angles: sitting, reclining, lying down.

- i** This seat can be used on seats not fitted with ISOFIX mountings.  
 In this case, it must be attached to the vehicle's seat using the three-point seat belt.  
 Adjust the front seat of the vehicle so that the child's feet do not touch the backrest.

**FAIR G 0/1 S and its base RWF B ISOFIX (size category C)****Group 0+ and 1: from birth to 18 kg**



Is installed rearward facing.  
 Is installed using an ISOFIX base attached to the rings **A**.  
 6 seat body angles.  
 Use the **type B** ISOFIX base **rearward facing (RWF)**.  
 This child seat can also be used in the forward facing position on seating positions not fitted with ISOFIX mountings.  
 In this case, the child seat body must be attached to the seat of the vehicle by the three point seat belt.

- i** Follow the instructions for fitting child seats contained in the seat manufacturer's installation guide.

## Locations for child seats

In accordance with European Regulations, this table indicates the options for installing ISOFIX child seats on seats in the vehicle fitted with ISOFIX mountings.

In the case of universal and semi-universal ISOFIX child seats, the ISOFIX size category, determined by a letter from **A** to **G**, is indicated on the child seat next to the ISOFIX logo.

	Weight of the child / indicative age									
	Less than 10 kg (group 0) Up to approx. 6 months		Less than 10 kg (group 0) Less than 13 kg (group 0+) Up to approx. 1 year			From 9 to 18 kg (group 1) From approx. 1 to 3 years				
Type of ISOFIX child seat	Infant car seat		rearward facing			rearward facing		forward facing		
ISOFIX size category	F	G	C	D	E	C	D	A	B	B1
Front passenger seat 	Not ISOFIX									
Outer rear seats 	X		IL-SU*	IL-SU	IL-SU*	IL-SU	IUF IL-SU			
Centre rear seat 	Not ISOFIX									

**IUF:** seat suitable for the installation of an Isofix **Universal** seat, **Forward** facing secured using the upper strap.

**IL-SU:** seat suitable for the installation of an Isofix **Semi-Universal** seat either:

- rearward facing fitted with an upper strap or a support leg,
- forward facing fitted with a support leg,
- an infant car seat fitted with an upper strap or a support leg.

For advice on securing the upper strap, refer to the "ISOFIX mountings" section.

**X:** seat not suitable for the installation of a child seat for the weight group indicated.

\* Vehicle seat in a particular position: move the seats in front of the child forward.

**!** Remove and stow the head restraint before installing a child seat on a passenger seat. Refit the head restraint once the child seat has been removed.

## ! Advice

The incorrect installation of a child seat in a vehicle compromises the child's protection in the event of an accident.

Ensure that there is no seat belt or seat belt buckle under the child seat, as this could destabilise it.

Remember to fasten the seat belts or the child seat harnesses keeping the slack relative to the child's body to a minimum, even for short journeys.

When installing a child seat using the seat belt, ensure that the seat belt is tightened correctly on the child seat and that it secures the child seat firmly on the seat of your vehicle. If your passenger seat is adjustable, move it forwards if necessary.

At rear seating positions, always leave sufficient space between the front seat and:

- a rearward facing child seat,
- the child's feet for a child seat fitted forward facing.

To do this, move the front seat forwards and, if necessary, move its backrest into the upright position.

For optimum installation of the forward facing child seat, ensure that the back of the child seat is as close as possible to the backrest of the vehicle's seat, in contact if possible. You must remove the head restraint before installing a child seat with backrest to a passenger seat.

Ensure that the head restraint is stored or attached securely to prevent it from being thrown around the vehicle in the event of sharp braking. Refit the head restraint when the child seat is removed.

## Children at the front

The legislation on carrying children on the front passenger seat is specific to each country. Refer to the legislation in force in your country.

Deactivate the passenger's front airbag when a rearward facing child seat is installed on the front passenger seat.

Otherwise, the child risks being seriously injured or killed if the airbag is deployed.

## Installing a booster seat

The chest part of the seat belt must be positioned on the child's shoulder without touching the neck.

Ensure that the lap part of the seat belt passes correctly over the child's thighs. PEUGEOT recommends the use of a booster seat which has a back, fitted with a seat belt guide at shoulder level.

As a safety precaution, do not leave:

- a child or children alone and unsupervised in a vehicle,
- a child or an animal in a vehicle which is exposed to the sun, with the windows closed,
- the keys within reach of children inside the vehicle.

To prevent accidental opening of the doors and rear windows, use the child lock.

Take care not to open the rear windows by more than one third.

To protect young children from the rays of the sun, fit side blinds on the rear windows.

# Child lock

## Manual operation

Mechanical system to prevent opening of a rear door using its interior lever.

The control is located on the edge of each rear door.

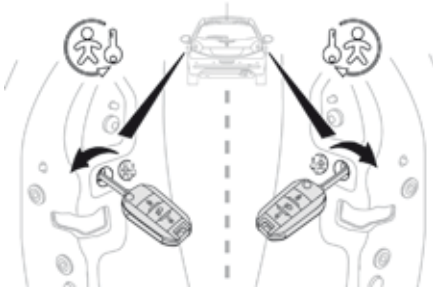

### Locking

- ☞ Using the ignition key, turn the red control as far as it will go:
  - to the left on the left-hand rear door,
  - to the right on the right-hand rear door.

### Unlocking

- ☞ Using the ignition key, turn the red control as far as it will go:
  - to the right on the left-hand rear door,
  - to the left on the right-hand rear door.

## Electric operation

Electric system, with the control located at the front, for locking the rear doors so that they cannot be opened using their interior controls.



### Switching on

- ☞ With the ignition on, press this button. The indicator lamp in the button comes on, accompanied by a message to confirm that the child lock is on. This indicator lamp remains on until the child lock is switched off. It is still possible to open the doors from the outside and operate the rear electric windows from the driver's control panel.

### Switching off

- ☞ With the ignition on, press this button again. The indicator lamp in the button goes off, accompanied by a message to confirm that the child lock is off. This indicator lamp remains off while the child lock is switched off.

**!** Any other status of the indicator lamp indicates a fault with the electric child lock. Have it checked by a PEUGEOT dealer or a qualified workshop.

**!** This system is independent and in no circumstances does it take the place of the central locking control. Check the state of the child lock every time you switch on the ignition. Always remove the key from the ignition when leaving the vehicle, even for a short time.

## Eco-driving

Eco-driving is a range of everyday practices that allow the motorist to optimise their fuel consumption and CO<sub>2</sub> emissions.

### Optimise the use of your gearbox

With a manual gearbox, move off gently and change up without waiting. During acceleration change up early.

With an automatic or electronic gearbox, give preference to automatic mode and avoid pressing the accelerator pedal heavily or suddenly.

The gear shift indicator invites you to engage the most suitable gear: as soon as the indication is displayed in the instrument panel, follow it straight away.

For vehicles fitted with an electronic or automatic gearbox, this indicator appears only in manual mode.

### Drive smoothly

Maintain a safe distance between vehicles, use engine braking rather than the brake pedal, and press the accelerator progressively. These practices contribute towards a reduction in fuel consumption and CO<sub>2</sub> emissions and also helps reduce the background traffic noise.

If your vehicle has cruise control, make use of the system at speeds above 25 mph (40 km/h) when the traffic is flowing well.

### Control the use of your electrical equipment

Before moving off, if the passenger compartment is too warm, ventilate it by opening the windows and air vents before using the air conditioning. Above 30 mph (50 km/h), close the windows and leave the air vents open.

Remember to make use of equipment that can help keep the temperature in the passenger compartment down (sunroof and window blinds...).

Switch off the air conditioning, unless it has automatic regulation, as soon as the desired temperature is attained.

Switch off the demisting and defrosting controls, if not automatic.

Switch off the heated seat as soon as possible.

Switch off the headlamps and front foglamps when the level of light does not require their use.

Avoid running the engine before moving off, particularly in winter; your vehicle will warm up much faster while driving.

As a passenger, if you avoid connecting your multimedia devices (film, music, video game...), you will contribute towards limiting the consumption of electrical energy, and so of fuel.

Disconnect your portable devices before leaving the vehicle.

## Limit the causes of excess consumption

Spread loads throughout the vehicle; place the heaviest items in the bottom of the boot, as close as possible to the rear seats.

Limit the loads carried in the vehicle and reduce wind resistance (roof bars, roof rack, bicycle carrier, trailer...). Use a roof box in preference. Remove roof bars and roof racks after use.

At the end of winter, remove snow tyres and refit your summer tyres.

## Observe the recommendations on maintenance

Check the tyre pressures regularly, when cold, referring to the label in the door aperture, driver's side.

Carry out this check in particular:

- before a long journey,
- at each change of season,
- after a long period out of use.

Don't forget the spare wheel and the tyres on any trailer or caravan.

Have your vehicle serviced regularly (engine oil, oil filter, air filter, passenger compartment filter...) and observe the schedule of operations recommended in the manufacturer's service schedule.

With a BlueHDi Diesel engine, if the SCR system is faulty your vehicle becomes polluting; go to a PEUGEOT dealer or a qualified workshop without delay to have the emissions of nitrous oxides brought back to the legal level.

When refuelling, do not continue after the third cut-off of the nozzle to avoid any overflow.

At the wheel of your new vehicle, it is only after the first 1 800 miles (3 000 kilometres) that you will see the fuel consumption settle down to a consistent average.

## Driving recommendations

Observe the driving regulations and remain vigilant whatever the traffic conditions.

Pay close attention to the traffic and keep your hands on the wheel so that you are ready to react at any time to any eventuality.

On a long journey, a break every two hours is strongly recommended.

In difficult weather, drive smoothly, anticipate the need to brake and increase the distance from other vehicles.

## Driving on flooded roads

We strongly advise against driving on flooded roads, as this could cause serious damage to the engine or gearbox, as well as to the electrical systems of your vehicle.

If you are obliged to drive through water:



- check that the depth of water does not exceed 15 cm, taking account of waves that might be generated by other users,
- deactivate the Stop & Start system,
- drive as slowly as possible without stalling. In all cases, do not exceed 6 mph (10 km/h),
- do not stop and do not switch off the engine.

On leaving the flooded road, as soon as circumstances allow, make several light brake applications to dry the brake discs and pads. If in doubt on the state of your vehicle, contact a PEUGEOT dealer or a qualified workshop.

## Important!

! Never drive with the parking brake applied - Risk of overheating and damage to the braking system!  
Do not park or run the engine when stationary in areas where inflammable substances and materials (dry grass, dead leaves...) might come into contact with the hot exhaust system - Risk of fire!

! Never leave a vehicle unsupervised with the engine running. If you have to leave your vehicle with the engine running, apply the parking brake and put the gearbox into neutral or position **N** or **P**, depending on the type of gearbox.

# Starting

## Ignition

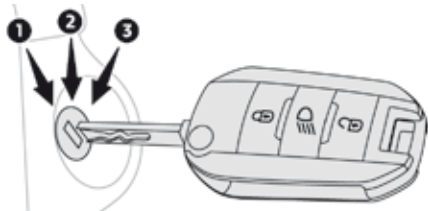

## Gearbox

### Manual

- ☞ Place the gear lever in neutral.

### Electronic

- ☞ Place the gear lever at position **N**.

### Automatic

- ☞ Place the gear lever at position **P** or **N**.

## Starting

- ☞ Insert the key into the ignition switch. The system recognises the starting code.
- ☞ Unlock the steering column by simultaneously turning the steering wheel and the key.
- ☞ Turn the key towards the dashboard to position **3 (Starting)**.
- ☞ When the engine starts, release the key.



### **i** Steering wheel

In some cases, you may have to apply some force to turn the steering (if the wheels are on lock against a kerb, for example).

## Electronic engine immobiliser

The original key contains a coded electronic chip. When the ignition is switched on, starting is only possible if the code is detected and recognised. This protection against theft locks the engine management system a few moments after the ignition is switched off and prevents starting of the engine following a break-in.

**SERVICE** In the event of a fault, you are informed by illumination of the warning lamp, an audible signal and the display of a message. In this case, your vehicle will not start; contact a PEUGEOT dealer as soon as possible.



### Advice

**i** Keep away from your vehicle, the label attached to the keys given to you on acquisition of the vehicle. It will help in finding the original code for replacement of the key.

**!** Avoid attaching heavy objects to the key or the remote control, which would weigh down on its blade in the ignition switch and could cause a malfunction. It could adversely affect the deployment of the front airbag.



## Moving off - Gearbox

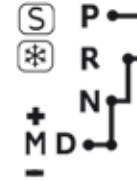
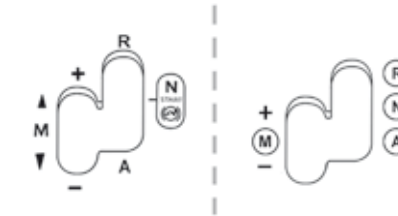
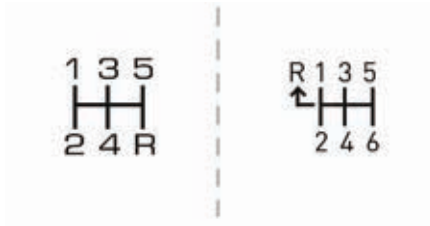

### Manual

- ☞ Start the engine.
- ☞ Press the clutch pedal fully down.
- ☞ Engage first gear.
- ☞ Release the parking brake.
- ☞ Progressively release the clutch pedal and accelerate away.



**!** Do not drive with your hand resting on the gear lever as this risks damaging the gearbox.

### Electronic

- ☞ To start the engine, place the lever at position **N**.
- ☞ Press firmly on the brake pedal.
- ☞ Start the engine.
- ☞ Select position **A**.
- ☞ Release the parking brake.
- ☞ Progressively release the brake pedal, then accelerate away.



**i** If you move off in position **M**, remember to operate the lever or a paddle to engage the gear.

### Automatic

- ☞ Apply the parking brake.
  - ☞ Select position **P** or **N**.
  - ☞ Start the engine.
- There is an audible signal, accompanied by the display of an alert message, if the gear lever is not in the right position.
- ☞ With the engine running, press the brake pedal.
  - ☞ Release the parking brake.
  - ☞ Select position **D**.
  - ☞ Progressively release the brake pedal.



The vehicle then moves off.

# Switching off

## Ignition

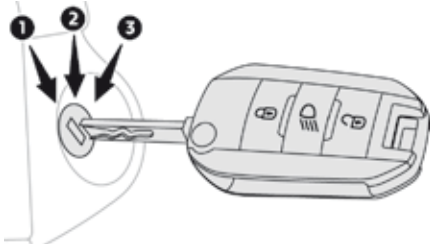

## Gearbox

### Manual

- ☞ Place the gear lever in neutral.
- ☞ Immobilise the vehicle.
- ☞ Apply the parking brake.
- ☞ Turn the key towards you to position **1 (Stop)**.
- ☞ Remove the key from the ignition switch.

### Electronic

- ☞ Place the gear lever at position **N**.
- ☞ Immobilise the vehicle.
- ☞ Apply the parking brake.
- ☞ Turn the key towards you to position **1 (Stop)**.
- ☞ Remove the key from the ignition switch.

## Automatic

- ☞ Place the gear lever at position **P** or **N**.
- ☞ Immobilise the vehicle.
- ☞ Apply the parking brake.
- ☞ Turn the key towards you to position **1 (Stop)**.
- ☞ Remove the key from the ignition switch.

### ! Coasting

As a safety measure, do not coast (free-wheeling in neutral or with the clutch pedal depressed).

- ! Switching off the engine leads to a loss of braking assistance.

### i Steering wheel

To facilitate unlocking of the steering wheel, it is recommended that you place the wheels in the straight ahead position before switching off the engine.

### i Key left in the "Ignition on" position

On opening the driver's door, an alert message is displayed, accompanied by an audible signal, to remind you that the key is still in the ignition switch at position **1 (Stop)**.

If the key has been left in the ignition switch at position **2 (Ignition on)**, the ignition will be switched off automatically after one hour. To switch the ignition back on, turn the key to position **1 (Stop)**, then back to position **2 (Ignition on)**.

## Parking brake

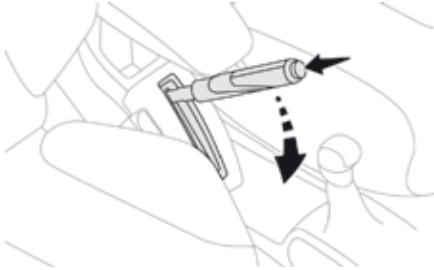

### Release

- ☞ Pull the parking brake lever up gently, press the release button then lower the lever fully.



When the vehicle is being driven, if this warning lamp and the **STOP** warning lamp come on, accompanied by an audible signal and a message in the screen, this indicates that the parking brake is still on or has not been fully released. Remember to fully lower the parking brake lever.



### Application

- ☞ Pull the lever up to immobilise your vehicle.

- ! When parking on a steep slope, direct your wheels against the kerb, apply the parking brake, engage a gear opposite to the direction the vehicle is facing and switch off the ignition. On return to the vehicle, remember that a gear had been engaged before starting the engine.

- ! If excessive travel or a loss of effectiveness of this system is noticed, the parking brake must be checked, even between two services. Checks of this safety-related system must be carried by a PEUGEOT dealer or a qualified workshop.

# Manual gearbox

## 5-speed

- ☞ Move the gear lever fully to the right to engage 5<sup>th</sup> gear.

### Engaging reverse gear



- ☞ Move the gear lever fully to the right then back.

**!** Only engage reverse gear when the vehicle is stationary and the engine is at idle.

## 6-speed

- ☞ Move the lever fully to the right to engage 5<sup>th</sup> or 6<sup>th</sup> gear.

### Engaging reverse gear

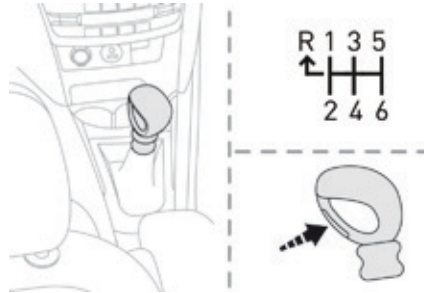

- ☞ Raise the collar below the gear lever knob, then push the lever fully to the left and then forward.

**!** Only engage reverse gear when the vehicle is stationary and the engine is at idle.

**i** As a safety precaution and to facilitate starting of the engine:

- always select neutral,
- press the clutch pedal.

**i** The gear shift indicator is displayed in the instrument panel.

# Electronic gearbox

## 5-speed

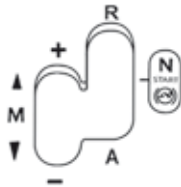

- R. Reverse.
- N. Neutral.
- A. Automated mode.
- M. Manual mode.

## 6-speed



- R. Reverse.
- N. Neutral.
- A. Automated mode.
- M. Manual mode.

**i** You can change from position **A** to **M** and from **M** to **A** at any time.

## A Automated mode

This mode allows gear changing without action by the driver.

### Moving off

Lever at position **N**.



- ☞ Press the brake pedal firmly.

- ☞ Start the engine.
- ☞ Place the lever at **A** or **R**.
- ☞ Release the brake pedal and press the accelerator pedal progressively.

If the engine does not start:

- If **N** is flashing in the instrument panel, move the lever to position **A** then to position **N**.
- If the message "**Foot on the brake**" is displayed, press firmly on the brake pedal.

The **A**, **R** or **N** position of the lever is indicated in the display.

## Stopping - Moving off on a slope

Do not use the accelerator to hold the vehicle, but apply the parking brake.

## Stopping - Parking

Place the lever at **N** and apply the parking brake.

## Manual gear changing



This **occasional** manual gear changing can be used for overtaking, for example, while remaining in automated mode.

☞ Operate the **+** or **-** steering mounted control paddle.

The gearbox engages the gear requested if the engine speed permits. **AUTO** remains displayed in the instrument panel.

After a few moments with no action on the controls, the gearbox returns to automatic management of the gears.

## M Manual mode



This mode allows manual sequential gear changing.

☞ Move the selector lever to **M**.

- +** ☞ Push the lever forward to change up.
- ☞ Pull the lever back to change down.

## Steering mounted control paddles



- ☞ Press the back of the **+** paddle to change up.
- ☞ Press the back of the **-** paddle to change down.

The gear engaged is indicated in the display.

## Creep function

Depending on the engine, the vehicle moves without pressing the accelerator.

## Assistance with low-speed manoeuvres

With the engine running at idle, parking brake released and the lever placed at **A**, **M** or **R**, the vehicle moves off when you release the brake pedal.

It stops on opening the driver's door. Closing the door, and putting your foot on the brake or accelerator pedal allows movement of the vehicle again.

## Advice

Following disconnection of the battery, you have to reinitialise the gearbox.

- ☞ Switch the ignition on.



**AUTO** and - appear in the instrument panel.

- ☞ Select position **N**.



- ☞ Press the brake pedal firmly.

- ☞ Wait around 30 seconds until **N** or a gear appears in the instrument panel.
- ☞ Release the brake pedal.

The gearbox is operational again.

## SERVICE

With the ignition on, the illumination of this warning lamp and the flashing of **AUTO**, accompanied by an audible signal and a message in the screen, indicate a gearbox fault.

Have it checked by a PEUGEOT dealer or a qualified workshop.

# Automatic gearbox



- P.** Park.
- R.** Reverse
- N.** Neutral.
- D.** Drive - AUTO driving mode.
- S.** Sport - More dynamic driving.
- \*** Snow - Driving on snow covered roads.

## Display in the instrument panel



When you select a position with the lever, the corresponding symbol is displayed in the instrument panel.

## Foot on the brake warning



Press the brake pedal when this comes on in the instrument panel.

## D Automated mode

This mode allows gear changes without action by the driver.

### Moving off

Parking brake applied.

- ☞ Start the engine.
- ☞ Lever at position **P** or **N**.



- ☞ Press firmly on the brake pedal.
- ☞ Release the parking brake.
- ☞ Place the selector at **D** or **R**.
- ☞ Release the brake pedal and press the accelerator pedal progressively.

The vehicle then moves off.



Never leave children unsupervised in the vehicles when the engine is running.





## Advice

# D

- Select position **D** for **automatic** changing of the gears.

The gearbox then operates in auto-adaptive mode, without action by the driver. It continuously selects the most suitable gear for the driving style, the relief of the road and the load in the vehicle.

For maximum acceleration, without touching the gear lever, press the accelerator pedal fully down (kick down). The gearbox changes down automatically or holds the gear engaged up to maximum engine speed.

When braking, the gearbox changes down automatically to provide effective engine braking.

When you take your foot off the accelerator pedal quickly, the gearbox does not change up, for your improved safety.

## M Manual mode

This mode allows manual sequential gear changing.

- Move the gear lever to **M**.

# +

- Push the lever forward to change up.

# -

- Pull the lever back to change down.

## Invalid value



This symbol is displayed if a gear is not properly engaged (selector between two positions).



You can change from **D** to **M** and **M** to **D** at any time.



When the engine is at idle, if position **R**, **D** or **M** is selected with the brakes released, the vehicle moves on its own without pressing the accelerator. Never leave children unsupervised inside the vehicle when the engine is running.

Apply the parking brake and select position **P** if carrying out a maintenance operation with the engine running.



Never select position **N** when the vehicle is moving. Never select positions **P** or **R** unless the vehicle is at a complete stop.



If position **N** is engaged by mistake when moving, take your foot off the accelerator pedal, then engage position **D** to accelerate. When the ambient temperature is below -23°C, the engine should be left running at idle for four minutes after starting, to ensure the correct operation and durability of the engine and gearbox.

## Sport programme

This special programme completes the automatic operation of the gearbox in certain circumstances.

**S**

- ☞ Press the "S" button once the engine is running.

The gearbox automatically operates in a way best suited to dynamic driving.

**S** appears in the instrument panel.

## Snow programme

This special programme completes the automatic operation and makes it easier to move off and make progress in conditions of poor grip.



- ☞ Press the ❄ button, once the engine has started.

The gearbox adapts its operation to driving on slippery surfaces.

❄ appears in the instrument panel.

## Return to normal automatic operation

**S**



- ☞ Press the button again at any time to quit the Sport programme and return to auto-adaptive mode.

## Switching off - Parking

Before switching off the engine.

- ☞ Move the lever to position **P** or **N**.
- ☞ Apply the parking brake.
- ☞ Immobilise the vehicle.

**i** If the lever is not in position **P**, a message appears in the screen on opening the driver's door or approximately 45 seconds after switching off the ignition.

- ☞ Place the lever at position **P**; the message disappears.

On flooded roads or when crossing a ford, drive at walking pace.

### SERVICE

With the ignition on, illumination of this warning lamp, accompanied by an audible signal and an alert message in the screen, indicates of gearbox fault.

In this case, the gearbox goes into back-up mode by staying in 3rd gear. You may then notice a pronounced jerk when changing from **P** to **R** and from **N** to **R**. This jerk does not present any risk to the gearbox.

Do not exceed 62 mph (100 km/h) while keeping to local speed limits.

Contact a PEUGEOT dealer or a qualified workshop as soon as possible.



You risk damaging the gearbox:

- ☞ if you press the brake and accelerator pedals at the same time,
- ☞ if you force the movement of the lever from position **P** to another position with a flat battery.

To reduce fuel consumption during prolonged stops with the engine running (traffic jams...), position the gear lever at **N** and apply the parking brake.

## Gear shift indicator

System which reduces fuel consumption by recommending the most appropriate gear.

Depending on the driving situation and your vehicle's equipment, the system may advise you to skip one (or more) gear(s). You can follow this instruction without engaging the intermediate gears.

The gear engagement recommendations must not be considered compulsory. This is because the configuration of the road, the traffic density and safety remain determining factors when choosing the best gear. Therefore, the driver remains responsible for deciding whether or not to follow the indications given.

This function cannot be deactivated.



The information appears in the instrument panel in the form of an arrow. It may be accompanied by a recommended gear.

- i The system adapts its gear change recommendation according to the driving conditions (slope, load, ...) and the demands of the driver (power, acceleration, braking, ...).  
The system never suggests:
  - engaging first gear,
  - engaging reverse gear.

- i With an electronic or automatic gearbox, the system is only active in manual mode.

## Hill start assist

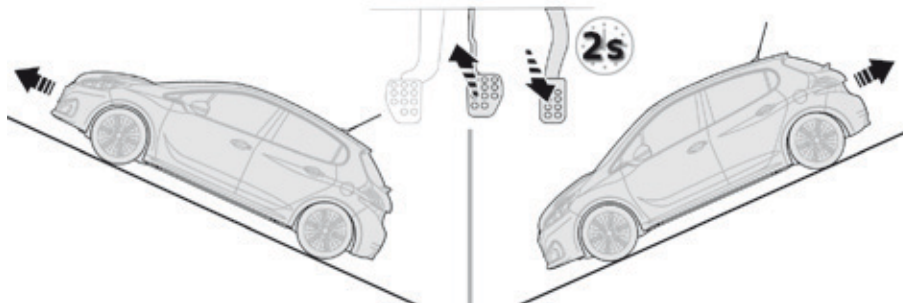

This system helps you move off on a slope, by holding your vehicle for around 2 seconds, the time to move your foot from the brake pedal to the accelerator.

**On an ascending slope with the vehicle stationary, the vehicle is held momentarily when you release the brake pedal.**

With an electronic gearbox, if you are in position **A**.

With an automatic gearbox, if you are in position **D**.

**On a descending slope, with the vehicle stationary and reverse gear engaged, the vehicle is held momentarily when you release the brake pedal.**

The hill start assist system is active when:

- your foot on the brake pedal fully immobilises the vehicle,
- when certain conditions of gradient are met,
- the driver's door is closed.

The hill start assist system cannot be deactivated.

**!** No one should leave the vehicle while it is being held in the hill start assist phase.

If you need to leave the vehicle while the engine is running, apply the parking brake manually then ensure that the parking brake warning lamp is on (not flashing) in the instrument panel.

### Operating fault

The fixed illumination of these warning lamps indicates a fault with the system.



**SERVICE**

Have the system checked by a PEUGEOT dealer or a qualified workshop.

## Stop & Start

The system puts the engine temporarily into standby - STOP mode - during stops in the traffic (red lights, traffic jams, ...). The engine restarts automatically - START mode - as soon as you want to move off. The restart takes place instantly, quickly and silently.

Perfect for urban use, the Stop & Start system reduces fuel consumption and exhaust emissions as well as the noise level when stationary.

### Operation

#### STOP mode

**ECO** The "ECO" lamp comes on in the instrument panel and the engine goes into standby.

#### With e-HDi or BlueHDi Diesel and an electronic gearbox:

- Speed below 4 mph (6 km/h).
- Gear lever in position **N**

Or

- Brake pedal pressed.

#### With BlueHDi Diesel and a manual gearbox:

- As soon as the vehicle stops.
- Gear lever in neutral and clutch pedal released.

#### With PureTech petrol and a manual, electronic or automatic gearbox:

- As soon as the vehicle stops.
- Gear lever in neutral and clutch pedal released (manual gearbox).
- Brake pedal pressed or gear lever in position **N** (electronic or automatic gearbox).

#### Special cases

STOP mode is not invoked when:

- the driver's door is open,
- the driver's seat belt is not fastened,
- the vehicle has not exceeded 6 mph (10 km/h) since the last engine start using the key,
- the engine is needed to maintain a comfortable temperature in the passenger compartment,
- demisting is selected,
- some special conditions (battery charge, engine temperature, braking assistance, ambient temperature...) where the engine is needed to assure control of a system.

**ECO** The "ECO" lamp flashes for a few seconds then goes off.

**This operation is perfectly normal.**



## Advice



### ECO

A time counter calculates the sum of the periods in STOP mode during a journey. It rests itself to zero every time the ignition is switched on with the key.

**i** For your comfort, during parking manoeuvres, STOP mode is not available for a few seconds after coming out of reverse gear. The Stop & Start system does not affect the functionality of the vehicle, such as for example, braking, ...

**i** With a manual gearbox in STOP mode, if you engage a gear without fully depressing the clutch pedal, a message is displayed asking you to fully depress the clutch pedal so that the engine can restart.

**!** Never refuel with the engine in STOP mode; you must switch off the ignition with the key.

## START mode

**ECO** The "ECO" lamp goes off and the engine restarts.

### With a manual gearbox:

- Clutch pedal depressed.

### With an electronic / automatic gearbox:

- Gear lever in position **A / D** or **M**.
- Brake pedal released.

or

- Gear lever in position **N**.
- Brake pedal released.
- Then gear lever in position **A / D** or **M**.

or

- Reverse gear engaged.

## Special cases

As a safety measure and for your comfort, START mode is invoked automatically when:

- you open the driver's door,
- you unfasten the driver's seat belt,
- some special conditions (battery charge, engine temperature, braking assistance, ambient temperature...) where the engine is needed for control of a system.

**ECO** The "ECO" warning lamp flashes for a few seconds, then goes off.

**This operation is perfectly normal.**

## Manual deactivation

In some circumstances, such as maintaining a comfortable temperature in the passenger compartment, it may be useful to deactivate Stop & Start.

The system can be deactivated at any time, once the ignition is on.

### ! Opening the bonnet

Before doing anything under the bonnet, deactivate the Stop & Start system to avoid the risk of injury related to an automatic change to START mode.



### ! Driving on flooded roads

Before driving through a flooded road, it is strongly recommended that you deactivate the Stop & Start system. For more advice on driving, particularly on flooded roads, refer to the corresponding section.



This control switches off the Stop & Start system.

- Press.
- The indicator lamp in the control remains on.
- A message is displayed.

If the vehicle is stationary in Stop mode, the engine immediately restarts.

## Manual reactivation

- Press.
- The indicator lamp in the control goes off.
- A confirmation message is displayed.

**i** If the engine is in STOP mode, it then restarts.  
The Stop & Start system is reactivated automatically every time the ignition is switched on.

## Operating fault



In the event of a fault with the system, the "ECO OFF" switch warning lamp flashes then comes on continuously.

Have it checked by a PEUGEOT dealer or a qualified workshop.

In the event of a fault in STOP mode, the vehicle may stall. All of the warning lamps come on. It is then necessary to switch off the ignition and start the engine again using the key.

**!** The Stop & Start system requires a 12 V battery of special specification and technology.

All work on this type of battery must be done by a PEUGEOT or a qualified workshop.

For more information on the 12 V battery, refer to the corresponding section.

# Speed limiter "LIMIT"

## Steering mounted controls

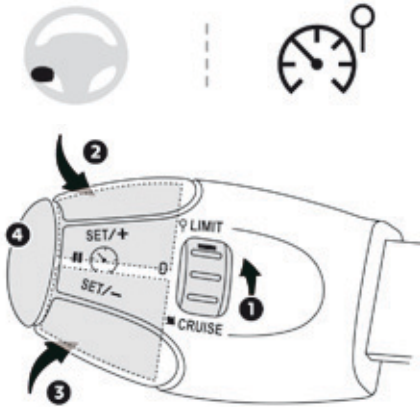

1. Speed limiter mode selection / off.
2. Increase the registered speed setting.
3. Decrease the registered speed setting.
4. Speed limiter On / Pause.

"This is the speed that the driver does not want to exceed".

The speed setting is selected with the engine running, stationary or when driving. The minimum speed setting possible is 20 mph (30 km/h).

The vehicle responds to the accelerator until resistance is felt in the pedal, which signifies that the vehicle has reached the limiter speed setting.

However, the limit speed can be exceeded by pressing the accelerator pedal beyond the point of resistance; simply release the accelerator pedal to return to a speed below the limiter setting.

**Setting and operation of the system can be done stationary with the engine running or when driving.**

## Selection



- ☞ Place the thumbwheel at the "LIMIT" position: the speed limiter mode is selected but is not switched on (PAUSE).

You do not have to switch the speed limiter on in order to set the speed.

## Registering a limit speed



This can be done without switching the limiter on, but the engine must be running.

To register a speed **higher** than the previous setting.

- Press the **SET +** button.

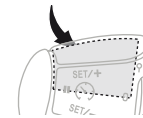

A short press increases the setting in steps of 1 mph (km/h). Pressing and holding increases the setting in steps of 5 mph (km/h).

To register a speed **lower** than the previous setting.

- Press the **SET -** button.

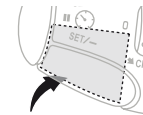

A short press decreases the setting by 1 mph (km/h).

Pressing and holding decreases the setting in steps of 5 mph (km/h).



## On / Pause



A first press on this button switches the speed limiter on, a second press pauses it (**OFF**).

## Exceeding the registered limit speed

Pressing the accelerator pedal to exceed the registered speed will not have any effect, unless you press the pedal **firmly** past the **point of resistance**.

The speed limiter is deactivated temporarily and the registered speed setting flashes, accompanied by an audible signal.

To return to normal operation of the speed limiter, reduce your speed to below the registered speed setting.

## Flashing of the speed setting



It flashes:

- after forcing the accelerator pedal past the point of resistance,
- when the limiter cannot prevent the speed of the vehicle increasing, because of the profile of the road or when going down a steep hill,
- under sharp acceleration.

## Switching off the function

- ☞ Place the thumbwheel at the **0** position or switch off the ignition to stop the system.

The last speed registered stays in memory.

## Operating fault



The registered speed is erased, then replaced by three dashes.

Have the system checked by a PEUGEOT dealer or a qualified workshop.



In no circumstances can the speed limiter replace the need to observe speed limits or the need for vigilance on the part of the driver.

Be aware of the effect of the profile of the road and sharp acceleration, maintaining control of the vehicle at all times.

To avoid any risk of interference below the pedals:

- ensure that the mat and its fixings on the floor are positioned correctly,
- do not fit one mat on top of another.

# Cruise control "CRUISE"

## Steering mounted controls

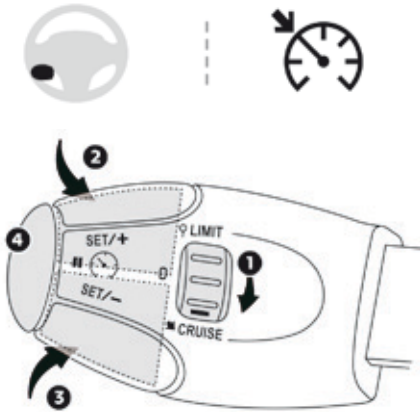

1. Cruise control mode selection / off.
2. Increase the registered speed setting.
3. Decrease the registered speed setting.
4. Cruise control Off / Resume.

"This is the speed the driver wishes to maintain".

This driving assistance system for use when the traffic is flowing, allows a speed set by the driver to be maintained, except on a steep gradient.

### With a manual gearbox

To be registered or activated, the speed of the vehicle must be above 25 mph (40 km/h) with 4th gear or higher engaged.

### With an electronic gearbox

To be registered or activated, the speed of the vehicle must be above 25 mph (40 km/h) with 2nd gear or higher engaged in manual mode, or position **A** selected.

### With an automatic gearbox

To be registered or activated, the speed of the vehicle must be above 25 mph (40 km/h) with 2nd gear or higher engaged in manual mode, or position **D** selected.

## Selection

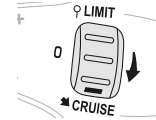

- Place the thumbwheel at the "CRUISE" position: the cruise control mode is selected but is not switched on (PAUSE).

## Registering a cruise speed setting



- Bring the vehicle up to the desired speed by pressing the accelerator.

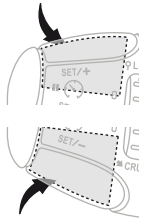

- Press the **SET -** or **SET +** button

The speed setting is registered/activated and the vehicle will maintain this speed.

## Temporarily exceeding the speed

It is possible to **accelerate** and temporarily drive at a speed higher than the registered speed setting.

The cruise speed setting value flashes. When the accelerator pedal is released, the vehicle will return to the registered speed setting.

## Pause (OFF)

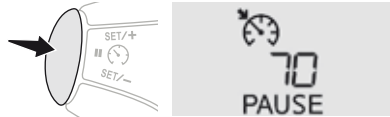

- Press this button or the brake or clutch pedal.

## Resume

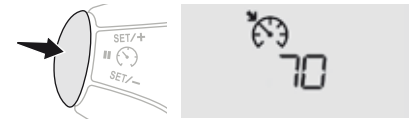

- After the cruise control has been paused, press this button.

The vehicle returns to the last registered speed. Or, you can also start the procedure for "Registering a cruise speed setting".

## Changing the registered speed setting



To register a speed **higher** than the previous setting, there are two possibilities.

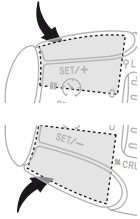

### Without using the accelerator

- Press the **SET +** button.

A short press increases the speed setting by 1 mph (km/h).  
Pressing and holding increases the setting in steps of 5 mph (km/h).

### Using the accelerator



- Accelerate beyond the registered speed to the new desired speed.

- Press the **SET +** or **SET -** button.

To register a speed **lower** than the previous setting:

- Press the **SET -** button.

A short press decreases the speed setting by 1 mph (km/h).  
Pressing and holding decreases the setting in steps of 5 mph (km/h).

## Switching off the function

- Place the thumbwheel at the "0" position: cruise control mode is deselected. The display returns to the total mileage recorder.

After switching off the ignition, all registered speed settings are lost.

## Operating fault



The registered speed setting is erased, then replaced by three dashes.  
Have it checked by a PEUGEOT dealer or a qualified workshop.

**!** Be vigilant when modifying the cruise control setting by pressing and holding, as the speed of your vehicle may increase or decrease quickly.  
Do not use the cruise control on slippery roads or in heavy traffic.  
On a steep descent, the cruise control will not be able to prevent the vehicle from exceeding the registered speed.  
The cruise control system cannot in any circumstances replace the need to observe speed limits or the need for vigilance on the part of the driver.  
To avoid any risk of jamming of the pedals:





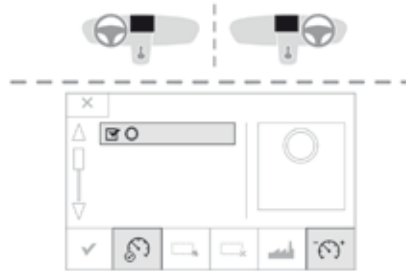

- ensure that the mat is positioned and secured to the floor correctly,
- never fit one mat on top of another.

# Speed settings



The speed values applied by the speed limiter "LIMIT" and the cruise control "CRUISE" can be saved (up to 5 different speed settings).



## With the touch screen

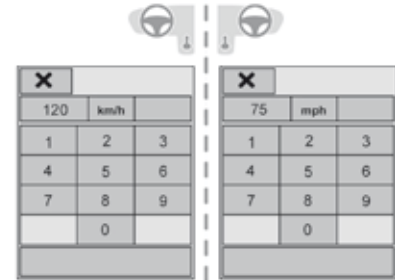

-  Go to the main menu by pressing the "MENU" button.
-  Select the "Driving" menu.
-  Select the secondary page.
-  Select "Speed settings".
-  Select the speed to be modified.
-  Press on "Modify".



-  Enter the new value.
-  Press on confirm.
-  Confirm to save the modifications and quit the menu.

 As a safety measure, the driver must only carry out these operations when stationary.

## Advice

-  Use this button to select all speeds.
-  Use this button to deselect all speeds.
-  This button restores the factory settings.

## At the steering mounted control

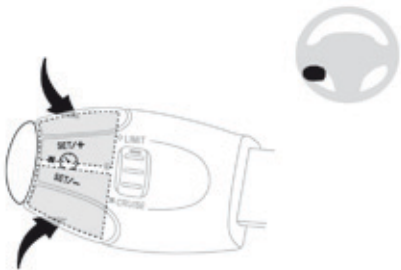

To select a saved speed:

- ☞ press and hold button "+" or "-"; the system stops at the closest saved speed,
- ☞ press and hold button "+" or "-" again to select another saved speed.

A reminder of the speed and the state of the system (on / off) is displayed in the instrument panel.

## Active City Brake



A preventive driving assistance system that, using a sensor located at the top of the windscreen, automatically applies the vehicle's brakes if driving behind a vehicle that is slowing down rapidly, stopping or is stationary.

The objective is to avoid a collision or reduce the speed of impact.

This system is designed to improve driving safety.

It remains the driver's responsibility to continuously monitor the state of the traffic and to assess the distances and relative speeds of other vehicles.

**!** The Active City Brake system can in no circumstances replace the need for vigilance on the part of the driver.



When your vehicle is too close to or approaches the vehicle ahead too quickly, the system automatically applies the brakes to avoid a collision.

If operation is triggered:

- Display of a message.
- Illumination of the brake lamps.

The automatic braking is triggered as a last resort, if the driver fails to apply the brakes sufficiently firmly or at all, or to take avoiding action.

**!** The laser beam is invisible. Never look at the laser sensor through an optical instrument (magnifying glass, microscope...): risk of eye injury.



### Conditions for operation:

- Vehicles driving in the same lane.
- Not in too sharp a bend.
- Speed of your vehicle between 3 and 18 mph (5 and 30 km/h).
- Braking assistance systems (ABS, EBD, EBA) in working order.
- Trajectory control systems (ASR, DSC) in working order and not deactivated.
- Operation of Active City Brake not triggered in the previous 10 seconds.

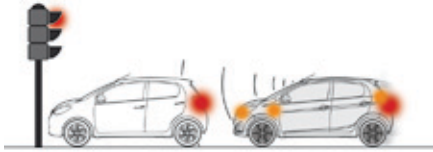

The automatic braking triggered:



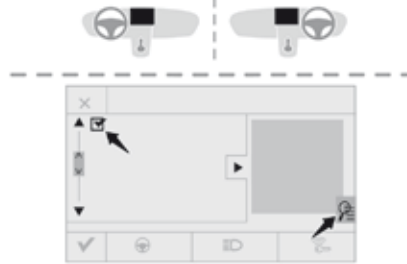

- can be even more effective if the driver presses the brake pedal more firmly,
- may stop the vehicle, holding the brakes on for 1.5 seconds when stationary to allow the driver time to take back control of the vehicle,
- may cause the engine to stall,
- may give rise to a pumping noise, due to the pressurisation of the braking system.

**i** The collision can be automatically avoided if the speed difference between your vehicle and the one ahead is not more than 9 mph (15 km/h). Above this threshold, the system will do what is possible to avoid or reduce the seriousness of the accident by lowering the speed of impact.

## Touch screen



### Activation

- MENU** Press "**MENU**" to display the "**MAIN MENU**".
-  Select "**Driving**".
-  Select "**Secondary page**".
-  Select "**Vehicle settings**".
-  Select the "**Driving assistance**" tab. Check the "**Automatic emergency braking activated**" box.
-  Confirm.

### Deactivation

Check the "**Automatic emergency braking deactivated**" box.

The last selection remains in memory when the ignition is switched off.

If the automatic emergency braking function is deactivated, following each start a temporary message will be displayed to signal this, once a speed threshold (6 mph - 10 km/h) is exceeded.

### To deactivate:

- Following an impact to the windscreen close to the sensor.
- When towing a trailer.
- When the vehicle is being towed.
- When the vehicle is about to cross a toll payment barrier.
- When the vehicle is going through an automatic car wash.



## Limits of operation

Not detected are:

- Pedestrians, animals, motorcyclists, cyclists.
- Fixed and non-reflective materials and objects (cardboard box, wall, ...).
- Vehicles not travelling in the same direction.

The system is not triggered or is interrupted if the driver:

- presses the accelerator pedal firmly,
- turns the wheel sharply (avoiding manoeuvre).

## Operating faults

Clean or clear any dirt, mist or objects (stickers, leaves, ...) from the top of the windscreen that could obstruct the laser's field of vision.

Misting of the windscreen or accumulations of snow on the bonnet could interfere with the operation of the laser. A message appears if the laser is obstructed.

Use windscreen demisting and regularly clean the area of the windscreen in front of the sensor.

Be particularly vigilant when driving in poor weather (very heavy rain, hail, fog, snow...).

This is because braking distances increase while the laser's calculation parameters remain the same.

In the following cases, you should have the system checked by a PEUGEOT dealer or a qualified workshop.

- The message "**Automatic braking system fault**" accompanied by an audible signal indicating that a fault has been detected.
- Following an impact, the system is automatically put out of service, it no longer works. The system detects the deployment of airbags.

**!** Do not attempt to remove, adjust or test the sensor.  
Only a PEUGEOT dealer or a qualified workshop is able to work on the system.

## Parking sensors

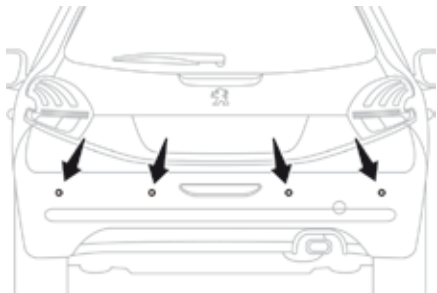

The audible (front and rear) and visual (rear) parking sensor system consists of proximity sensors, installed in the rear bumper.

The sensors detect any obstacle which enters its field of operation (person, vehicle, tree, fence, ...) behind the vehicle during the manoeuvre.

Certain objects detected at the beginning of the manoeuvre will no longer be detected at the end of the manoeuvre due to the blind spots between and below the sensors.

Examples: stake, roadworks cone or pavement post.

### Engage reverse gear



An audible signal confirms the activation of the system by engaging reverse gear.

The proximity information is indicated by an audible signal which becomes more rapid as the vehicle approaches the obstacle.

When the distance between the rear of the vehicle and the obstacle is less than approximately 30 centimetres, the audible signal becomes continuous.

### Display in the screen

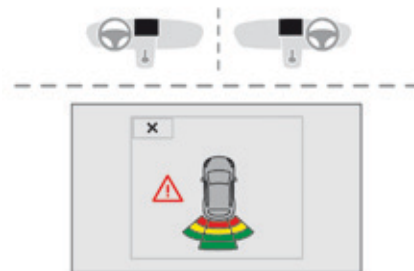

This completes the audible signal by the display of bars in the multifunction screen, which become closer and closer as the vehicle approaches the obstacle. When very close to the obstacle, the "Danger" symbol is displayed in the screen.

## Stopping the assistance

**N** Change to neutral.



## Switching off the assistance

Press; the indicator lamp comes on.  
The state of the system is stored when the vehicle is switched off.

## Resuming assistance

Press again; the indicator lamp goes off.

**SERVICE** If this warning lamp comes on when reverse gear is engaged, accompanied by a message and/or an audible signal, a fault has been detected.

Contact a PEUGEOT dealer or qualified workshop.

## Advice

In bad weather or in winter, ensure that the sensors are not covered with mud, ice or snow. The system will be deactivated automatically if a trailer is being towed or if a bicycle carrier is fitted (vehicle fitted with a towbar or bicycle carrier recommended by PEUGEOT).

**!** The parking sensor system cannot in any circumstances replace the need for vigilance on the part of the driver.

## Reversing camera

The reversing camera is activated automatically when reverse gear is engaged.

The image is displayed in the touch screen.

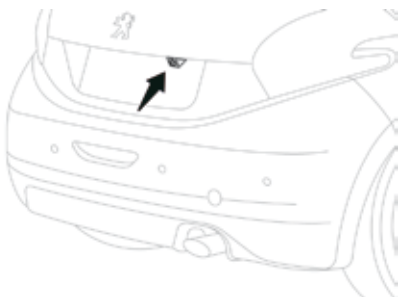

The reversing camera function may be completed with parking sensors.

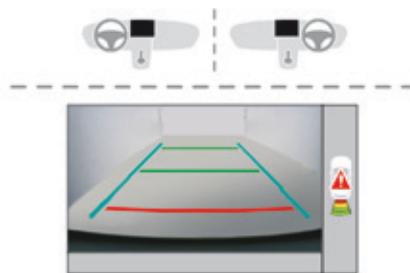

The superimposed representation of guide lines helps with the manoeuvre.

They are represented by lines marked "on the ground" and do not allow the position of the vehicle to be determined relative to tall obstacles (for example: other vehicles, ...). Some deformation of the image is normal.

The blue lines represent the general direction of the vehicle (the difference corresponds to the width of your vehicle without the mirrors).

The red lines represent a distance of about 30 cm beyond the edge of your vehicle's rear bumper.

The green lines represent distances of about 1 and 2 metres beyond the edge of your vehicle's rear bumper.

**!** The reversing camera cannot in any circumstances be a substitute for vigilance on the part of the driver.

**i** **High pressure jet washing**  
When washing your vehicle, do not direct the lance within 30 cm of the camera lens.

**i** Opening the tailgate causes the display to disappear.

**i** Clean the reversing camera regularly using a soft, dry cloth.

## Park Assist

The system detects a parking space and then provides assistance with the parallel parking manoeuvres.

It controls the steering and provides visual and audible information to the driver.

The driver manages the accelerator, brakes, gears and the clutch in the case of a manual gearbox.

- ! The Park Assist system cannot in any circumstances replace the need for vigilance on the part of the driver. The driver must remain in control of their vehicle ensuring that the space remains clear during the manoeuvre. In some circumstances, the sensors may not detect small obstacles located in their blind spots.

- ! During a manoeuvre the steering wheel turns quickly: do not hold the steering wheel, do not place your hand between the spokes of the steering wheel and take care with loose and bulky clothing, scarves, handbags... There is a risk of injury.

- i For entry into a parking space (parallel parking) the system does not detect spaces which are clearly much smaller or larger than the size of the vehicle. This "parking assistance" system is activated automatically during manoeuvres; it is therefore possible that a symbol comes on in the screen, accompanied by an audible signal, without affecting the manoeuvre.

- i Changing tyre sizes (out-size tyres, winter tyres, ...) can interfere with the correct operation of the parking assistance system.

- i The selection of the type of manoeuvre (entering or exiting a parallel parking space) prevents a change to STOP mode of Stop & Start. In STOP mode, this selection restarts the engine.

The driver can take back control of the steering at any time by grasping the wheel.



The system provides assistance in entering and exiting a parking space when parallel parking.

## Entering a parallel parking space

- When you have identified a free space, reduce the speed of the vehicle to a maximum of 12 mph (20 km/h).



- Position your vehicle before this space.



To activate the Park Assist system:

- Press this control to activate the system. The indicator lamp in the control remains off.

A message is displayed in the screen.

- Select the enter parking space manoeuvre. The indicator lamp in the control comes on.

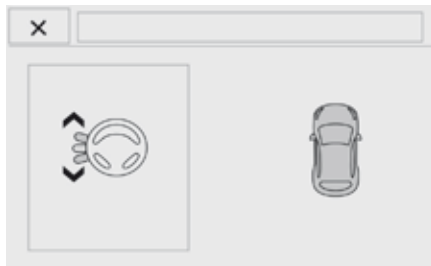

- Operate the direction indicator on the parking side.

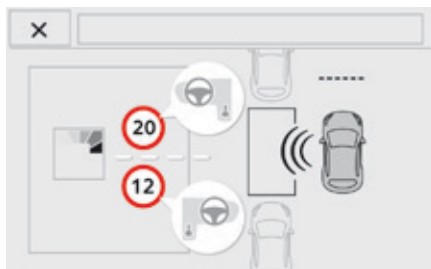

- Move forwards alongside the parking space at a speed below 12 mph (20 km/h) to measure it, keeping at a distance of between 0.5 and 1.5 metres from the row of parked vehicles.

Once measurement is complete, if the space is large enough a message indicates that parking is possible.



- Move your vehicle forward until a new message is displayed.



- Select reverse and release the steering wheel.

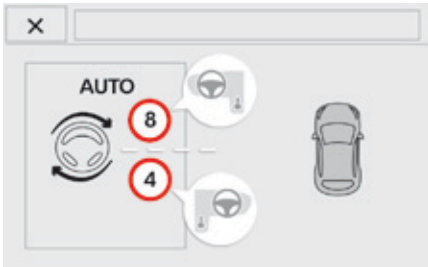

The assisted parking manoeuvre is in progress. Without exceeding 5 mph (8 km/h), continue the manoeuvres following the information given by the "parking assistance" system, until the end of manoeuvre message is displayed. The indicator lamp in the control goes off, accompanied by a audible signal.



The driver takes back control of the vehicle's steering.

## Exit from a parallel parking space

- When you want to exit from a parallel parking space, start the engine.



With the vehicle stationary, to activate the Park Assist system:

- Press this control.
- The indicator lamp in the control remains off.

A message is displayed in the screen.

- Select the exit parking space manoeuvre. The indicator lamp in the control comes on.
- Operate the direction indicator on the exit from parking side. The direction indicator warning lamp flashes in the instrument panel throughout the manoeuvre, whatever the position of the stalk.
- Select a forward or reverse gear then release the steering wheel.

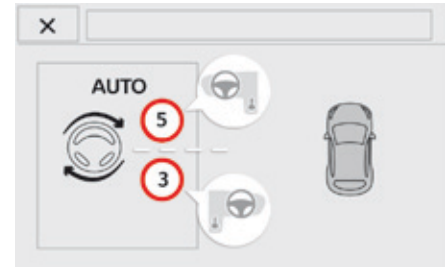

The assisted exit from parking manoeuvre is in progress. Without exceeding 5 mph (8 km/h), continue the manoeuvres following the information given by the "parking assistance" system, until the end of manoeuvre message is displayed. The manoeuvre is complete once the front wheels of the vehicle are out of the parking space. The indicator lamp in the control goes off, accompanied by a audible signal.



The driver takes back control of the vehicle's steering.

## Deactivation

The system is deactivated automatically:

- on switching off the ignition,
- if the engine stalls,
- if no manoeuvre is started within 5 minutes of selection of the type of manoeuvre,
- after a prolonged stop of the vehicle during a manoeuvre,
- if the road wheel anti-spin regulation (ASR) is triggered,
- if the speed of the vehicle exceeds the stated limit,
- when the driver interrupts movement of the steering wheel,
- if the driver presses the Park Assist control,
- if correct positioning of the vehicle is not possible (too many manoeuvres needed to insert or extract the vehicle),
- if the driver's door is open,
- if one of the front wheels encounters an obstacle.

**!** If the system is deactivated during a manoeuvre, the driver should reactivate it manually to repeat the measurement.

A message is displayed in the screen.



The driver then takes back control of the vehicle's steering.

## Switching off

The system is switched off automatically:

- when towing a trailer,
- if the driver's door is opened,
- if the speed of the vehicle is above 42 mph (70 km/h).

To switch the system off for a prolonged period, contact a PEUGEOT dealer or a qualified workshop.

### SERVICE

This warning lamp is displayed in the instrument panel and/or a message appears in the screen, accompanied by an audible signal (short beep).

The indicator lamp in the control flashes for a few seconds. If the problem occurs while using the system, the indicator lamp goes off.

### STOP



These warning lamps indicate a fault with the power steering.

Contact a PEUGEOT dealer or a qualified workshop.



If the lateral distance between your vehicle and the space is too great, the system may not be able to measure the space. Anything projecting beyond the envelope of the vehicle (long or wide load) is not taken into account by the Park Assist system during a manoeuvre.



In bad weather and in winter, ensure that the sensors are not covered by road dirt, ice or snow. In the event of a fault, have the system checked by a PEUGEOT dealer or a qualified workshop.



## Under-inflation detection

System which automatically checks the pressures of the tyres while driving.

The system monitors the pressures in the four tyres, once the vehicle is moving. It compares the information given by the four wheel speed sensors with **reference values, which must be reinitialised every time the tyre pressures are adjusted or a wheel changed.**

The system triggers an alert as soon as it detects a drop in the inflation pressure of one or more tyres.



The under-inflation detection system does not replace the need for vigilance on the part of the driver.

This system does not avoid the need to check the tyre pressures (including the spare wheel) every month as well as before a long journey.

Driving with under-inflated tyres impairs road holding, extends braking distances and causes premature tyre wear, particularly under arduous condition (high loading, high speed, long journey).



Driving with under-inflated tyres increases fuel consumption.

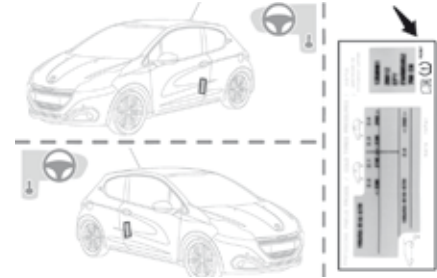

The inflation pressures defined for your vehicle can be found on the tyre pressure label. See the "Identification markings" section.

Tyre pressures should be checked when the tyres are "cold" (vehicle stopped for 1 hour or after a journey of less than 6 miles (10 km) at moderate speeds).

Otherwise (when hot), add 0.3 bar to the pressures shown on the label.

## Under-inflation alert



This is given by fixed illumination of this warning lamp, accompanied by an audible signal and, depending on equipment, the display of a message.

- ☞ Reduce speed immediately, avoid excessive steering movements and sudden braking.
- ☞ Stop the vehicle as soon as it is safe to do so.



The loss of pressure detected does not always cause visible bulging of the tyre. Do not satisfy yourself with just a visual check.

- ☞ In the event of a puncture, use the temporary puncture repair kit or the spare wheel (depending on equipment),
- or
- ☞ if you have a compressor, such as the one in the temporary puncture repair kit, check the pressures of the four tyres when cold,
- or
- ☞ if it is not possible to make this check immediately, drive carefully at reduced speed.



The alert is maintained until the system is reinitialised.



The under-inflation alert can only be relied on if the system has been reinitialised with all four tyres inflated to the correct pressures.



### Snow chains

The system does not have to be reinitialised after fitting or removing snow chains.

## Reinitialisation

It is necessary to reinitialise the system every time one or more tyre pressures are adjusted, and after changing one or more wheels.

**!** Before reinitialising the system, ensure that the pressures of the four tyres are correct for the use of the vehicle and in line with the recommendations on the tyre pressure label.

The under-inflation alert can only be relied on if the reinitialisation of the system has been done with the pressures in the four tyres correctly adjusted.

The under-inflation detection system does not give a warning if a pressure is incorrect at the time of reinitialisation.

**i** Before doing anything to the system, the pressures of the four tyres must be checked and the system reinitialised.

## Touch screen

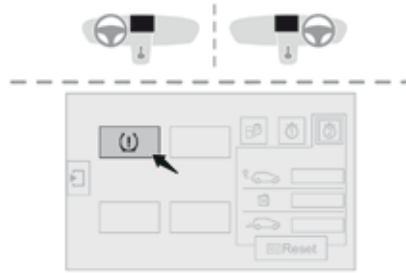

Reinitialisation of the system is done with the ignition on and the vehicle stationary.

 From the **"Driving assistance"** menu of the touch screen:

 Press **"Under-inflation initialisation"**.

☞ Confirm the instruction by pressing **"Yes"**, an audible signal and a message confirm the reinitialisation.

**!** The new pressure settings registered are considered to be reference values by the system.

## Screen A



☞ With the ignition on and the vehicle stationary, press this button for about 3 seconds then release it, an audible signal confirms the reinitialisation.

## Operating fault

The flashing and then fixed illumination of the under-inflation warning lamp accompanied by illumination of the Service warning lamp indicates a fault with the system.

In this case, under-inflation monitoring of the tyres is no longer assured.

Have the system checked by a PEUGEOT dealer or a qualified workshop.

## Fuel tank

**Fuel tank capacity: approximately 50 litres.**

### Low fuel level



When the low fuel level is reached this warning lamp comes on in the instrument panel. There remains **approximately 5 litres** of fuel in the tank. When the warning lamp flashes, there is **very little fuel left**.

You must refuel as soon as possible to avoid running out of fuel.

If you run out of fuel (Diesel), refer to the "Running out of fuel - Diesel" section.

**i** The key cannot be removed from the lock until the cap is refitted. Removing the filler cap may cause an inrush of air. This vacuum is perfectly normal and results from the sealing of the system.

**!** With Stop & Start, never refuel with the system in STOP mode; you must switch off the ignition with the key.

### Refuelling

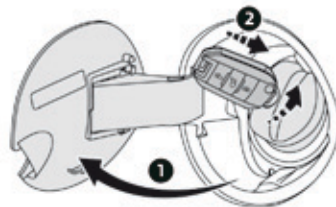

1. Open the filler flap.
2. Remove the filler cap.
3. Hook the filler cap.

A self-adhesive label on the inner face of the filler flap reminds you of the type of fuel to use depending on your engine.

Additions of fuel must be of at least 5 litres to be registered by the fuel gauge.

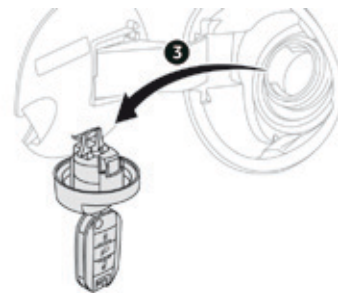

To fill the tank safely:

- ☞ **the engine must be switched off,**
- ☞ open the fuel filler flap 1,
- ☞ insert the key in the cap 2, then turn it to the left,
- ☞ remove the cap and hook it onto the clip located on the inside of the flap 3,
- ☞ fill the tank, **but do not continue after the 3rd cut-off of the pump**; this could cause malfunctions.

When you have filled the tank:

- ☞ put the cap back in place,
- ☞ turn the key to the right, then remove it from the cap,
- ☞ close the flap.

**!** If you have put in the wrong fuel for the engine of your vehicle, you must have the fuel tank drained and filled with the correct fuel before starting the engine.

## Fuel supply cut-off

Your vehicle is fitted with a safety system that cuts off the supply of fuel in the event of an impact.

## Diesel Particle filter

### SERVICE

The start of saturation of the particle filter is indicated by the fixed illumination of this warning lamp accompanied by a warning message in the screen (if a display screen is fitted).

As soon as the traffic conditions permit, regenerate the filter by driving at a speed of at least 40 mph (60 km/h) until the warning lamp goes off.

If the warning lamp stays on, this indicates a low additive level.

- i** On a new vehicle, the first particle filter regeneration operations may be accompanied by a "burnt" smell, which is normal.  
Following prolonged operation of the vehicle at very low speed or at idle, you may, in exceptional circumstances, notice the emission of water vapour at the exhaust on acceleration. This does not affect the behaviour of the vehicle or the environment.

## Diesel additive

### SERVICE

A low additive level is indicated by illumination of the service warning lamp, accompanied by an audible warning and a message in the screen (if a display screen is fitted).

### Topping-up

This additive must be topped up by a PEUGEOT dealer or a qualified workshop without delay.

## Misfuel prevention

### On vehicles with Diesel engines

Mechanical device which prevents filling the tank of a Diesel vehicle with petrol. It avoids the risk of engine damage that can result from filling with the wrong fuel.

Located in the filler neck, the misfuel prevention device appears when the filler cap is removed.

### Operation

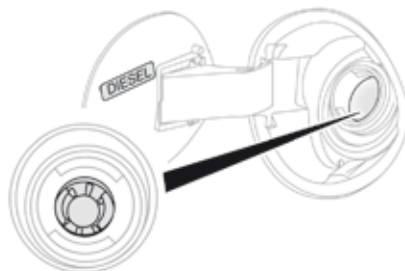

When a petrol filler nozzle is introduced into the fuel filler neck of your Diesel vehicle, it comes into contact with the flap. The system remains closed and prevents filling.

**Do not persist but introduce a Diesel type filler nozzle.**

### **i** Travelling abroad

As Diesel fuel pump nozzles may be different in other countries, the presence of the misfuel prevention device may make refuelling impossible. Not all Diesel vehicles are fitted with misfuel protection, so before travelling abroad, we recommend that you check with the PEUGEOT dealer network, whether your vehicle is suitable for the fuel pumps in the country in which you intend to travel.

- i** It remains possible to use a fuel can to fill the tank.  
In order to ensure a good flow of fuel, do not place the nozzle of the fuel can in direct contact with the flap of the misfuel prevention device and pour slowly.

## Fuel used for petrol engines

The petrol engines are compatible with E10 bio-petrol (containing 10 % ethanol), conforming to European standards EN 228 and EN 15376.

E85 type fuels (containing up to 85 % ethanol) are reserved exclusively for vehicles marketed for the use of this type of fuel (BioFlex vehicles). The quality of the ethanol must comply with European standard EN 15293.

## Fuel used for Diesel engines

The Diesel engines are compatible with biofuels available at the pumps which meet current and future European standards:

- Diesel fuel that meets standard EN 590 mixed with a biofuel that meets standard EN 14214,
- Diesel fuel that meets standard EN 16734 mixed with a biofuel that meets standard EN 14214 (possibly containing up to 10 % Fatty Acid Methyl Ester),
- Paraffinic Diesel fuel that meets standard EN 15940 mixed with a biofuel that meets standard EN 14214 (possibly containing up to 7 % Fatty Acid Methyl Ester).

The use of B20 or B30 fuel meeting standard EN 16709 is possible in your Diesel engines. However, this use, even occasional, requires strict application of the special servicing conditions referred to as "Arduous conditions". For more information, contact a PEUGEOT dealer or a qualified workshop.

The use of any other type of (bio)fuel (vegetable or animal oils, pure or diluted, domestic fuel...) is strictly prohibited (risk of damage to the engine and fuel system). Only the use of Diesel fuel additives that meet the standard B715000 is authorised.



## Snow chains

In wintry conditions, snow chains improve traction as well as the behaviour of the vehicle when braking.

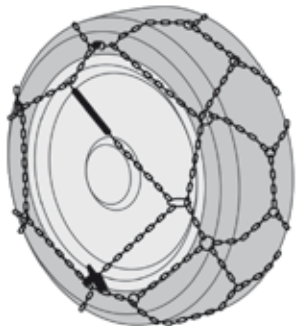

Use only the chains designed to be fitted to the type of wheel fitted to your vehicle:

Original tyre size	Maximum link size.
185/65 R15	9 mm
195/55 R16	
205/45 R17	7 mm

For more information on snow chains, contact a PEUGEOT dealer or a qualified workshop.

**i** The snow chains must be fitted only to the front wheels. They must never be fitted to "space-saver" type spare wheels.

Take account of the legislation in force in your country on the use of snow chains and the maximum running speed authorised.

### Advice on installation

- f** If you have to fit the chains during a journey, stop the vehicle on a flat surface on the side of the road.
- f** Apply the parking brake and position any wheel chocks to prevent movement of your vehicle.
- f** Fit the chains following the instructions provided by the manufacturer.
- f** Move off gently and drive for a few moments, without exceeding 30 mph (50 km/h).
- f** Stop your vehicle and check that the snow chains are correctly tightened.

**i** Avoid driving with snow chains on roads that have been cleared of snow, to avoid damaging your vehicle's tyres and the road surface. If your vehicle is fitted with alloy wheels, check that no part of the chain or its fixings is in contact with the wheel rim.

It is strongly recommended that before you leave, you practise fitting the snow chains on a level and dry surface.



## Towing a trailer



Your vehicle is primarily designed for transporting people and luggage, but it may also be used for towing a trailer.

**i** We recommend the use of genuine PEUGEOT towbars and their harnesses that have been tested and approved from the design stage of your vehicle, and that the fitting of the towbar is entrusted to a PEUGEOT dealer or a qualified workshop.

If the towbar is not fitted by a PEUGEOT dealer, it must still be fitted in accordance with the vehicle manufacturer's instructions.

**i** Driving with a trailer places greater demands on the towing vehicle and the driver must take particular care. For more advice on driving when towing, refer to the corresponding section.

**i** For more information on weights (and the towed loads which apply to your vehicle) refer to the corresponding section.

**!** You must observe the maximum trailer weight, indicated on the registration certificate or in the technical specification for your vehicle.

## When towing

### Distribution of loads

- ☞ Distribute the load in the trailer so that the heaviest items are as close as possible to the axle and the nose weight approaches the maximum permitted without exceeding it.

Air density decreases with altitude, thus reducing engine performance. Above 1 000 metres, the maximum towed load must be reduced by 10 % for every 1 000 metres of altitude.

For more information on weights (and the towed loads which apply to your vehicle) refer to the corresponding section.

### Side wind

- ☞ Take into account the increased sensitivity to side wind.

### Cooling

Towing a trailer on a slope increases the temperature of the coolant. As the fan is electrically controlled, its cooling capacity is not dependent on the engine speed.

- ☞ To lower the engine speed, reduce your speed.

The maximum towed load on a long incline depends on the gradient and the ambient temperature. In all cases, keep a check on the coolant temperature.



- ☞ If the warning lamp and the **STOP** warning lamp come on, stop the vehicle and switch off the engine as soon as possible.

### Braking

Towing a trailer increases the braking distance. To avoid overheating of the brakes, the use of engine braking is recommended.

### Tyres

- ☞ Check the tyre pressures of the towing vehicle and of the trailer, observing the recommended pressures.

### Lighting

- ☞ Check the electrical lighting and signalling on the trailer and the headlamp beam height of your vehicle.

For more information on adjusting the headlamp beam height, refer to the corresponding section.

**i** The rear parking sensors will be deactivated automatically if a genuine PEUGEOT towbar is used.

# Energy load

## Load reduction mode

System which manages the use of certain functions according to the level of charge remaining in the battery.

When the vehicle is being driven, the load reduction function temporarily deactivates certain functions, such as the air conditioning, the heated rear screen...

The deactivated functions are reactivated automatically as soon as conditions permit.

## Economy mode

System which manages the period of use of certain functions to maintain an adequate state of charge of the battery.

After switching off the engine and for a maximum cumulative period of around 30 minutes, you can continue to use functions such as the audio and telematic system, the wipers, dipped beam, courtesy lamps, ...

## Entry into the mode

Once this time has elapsed, a message advising the entry into energy economy mode appears in the screen and the active functions are put on standby.

If a telephone call is in progress at this time, the connection via the audio system's hands-free function will be maintained for around 10 minutes.

## Coming out of the mode

These functions will be automatically restored the next time the vehicle is used.

To restore the use of these functions immediately, start the engine and allow it run for at least 5 minutes.



The engine will not start if the battery is discharged.

## Accessories

A wide range of accessories and genuine parts is available from the PEUGEOT dealer network. These accessories and parts are all suitable for your vehicle and benefit from PEUGEOT's recommendation and warranty.

**!** The fitting of electrical equipment or accessories which are not recommended by PEUGEOT may result in a failure of your vehicle's electronic system and excessive electrical consumption. Contact a PEUGEOT dealer for information on the range of recommended equipment and accessories.

### Conversion kits

You can obtain an "Enterprise" kit to convert a trade vehicle to a private car and vice-versa.

### "Comfort":

door deflectors, side blinds and rear blind, cigarette lighter, boot dividers, coat hanger fixed to head restraint, front centre armrest, under shelf storage, front and rear parking sensors...

### "Transport solutions":

boot liner with dividers, luggage net, roof bars, bicycle carrier on roof bars, ski carrier, roof box...

### "Styling":

aluminium gear lever knob, spoiler, styling strips, alloy wheels, trims, chromed mirror shells, stickers, interior and exterior mirror shells, parking brake lever grips, alloy wheel caps...

### "Security":

anti-theft alarm, window engraving, wheel security bolts, child seats and booster cushions, breathalyzer, first aid kit, warning triangle, high visibility jacket, stolen vehicle tracking system, temporary puncture repair kit, snow chains, non-slip covers, front foglamps kit...

### "Protection":

mats, seat covers compatible with lateral airbags, mud flaps, side protection rubbing strips, bumper protection rubbing strips, aluminium or PVC door aperture finishers... To avoid any risk of jamming of the pedals:

- ensure that the mat is positioned and secured correctly,
- never fit one mat on top of another.

**!** Tow bar, which must be fitted by PEUGEOT dealer or a qualified workshop.

## "Multimedia":

audio systems, portable satellite navigation systems, semi-integral support for portable satellite navigation system, hands-free kit, speakers, DVD player (depending on version), connection kit for MP3 player...

### **i** Installation of radio communication transmitters

Before installing any after-market radio communication transmitter, you can contact a PEUGEOT dealer for the specification of transmitters which can be fitted (frequency, maximum power, aerial position, specific installation requirements), in line with the Vehicle Electromagnetic Compatibility Directive (2004/104/EC).

By visiting a PEUGEOT dealer, you can also obtain products for cleaning and maintenance (exterior and interior) - including ecological products in the "TECHNATURE\*" range, topping up products (screenwash...), touch-up pens and paint aerosols for the exact colour of your vehicle, refills (cartridge for the temporary puncture repair kit...), ...

**i** Depending on the legislation in force in the country, certain safety equipment may be compulsory: high visibility safety vests, warning triangles, breathalyzers, spare bulbs, spare fuses, fire extinguisher, first aid kit, mud flaps at the rear of the vehicle.

\* The "TECHNATURE" range comprises products for the care and maintenance of your vehicle, recommended and approved by PEUGEOT.

## Changing a wiper blade

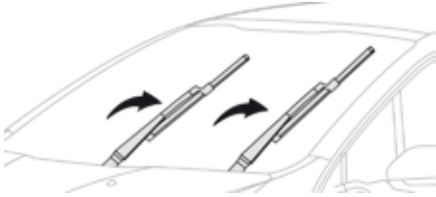

This position allows the wiper blades to be moved away from the windscreen. It is used for cleaning or replacement of the blades. It can also be useful, in winter, to release the wiper blades from the windscreen.

To move the wiper blades to the vertical position:

- ☞ Any action on the wiper stalk in the minute after switching off the ignition places the wiper blades vertically on the screen.

To return them to the park position:

- ☞ Switch on the ignition and operate the wiper stalk.

### Removing a wiper blade

- ☞ Lift the corresponding wiper arm away from the windscreen.
- ☞ Unclip and remove the wiper blade.

### Fitting the new wiper blade

- ☞ Position and clip the new wiper blade to the arm.
- ☞ Carefully lower the wiper arm.

- i** To maintain the effectiveness of the flat wiper blades, it is advisable to:
  - handle them with care,
  - clean them regularly using soapy water,
  - avoid using them to retain cardboard on the windscreen,
  - replace them at the first signs of wear.

## Fitting roof bars

When fitting transverse roof bars, take care to position them correctly on the retaining pins located in the door apertures.

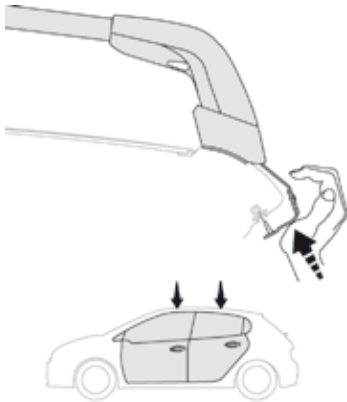

**!** Use accessories recommended by PEUGEOT observing the manufacturer's recommendations and fitting instructions so as to avoid the risk of damaging the body (deformation, scratches, ...).

**i** Do not exceed the maximum authorised load, shown in the instructions for the roof bars.

If the height exceeds 40 cm, adapt the speed of the vehicle to the profile of the road to avoid damaging the roof bars and the fixings on the roof.

Be sure to refer to national legislation in order to comply with the regulations for transporting objects which are longer than the vehicle.



## PEUGEOT & TOTAL, A PARTNERSHIP TO DELIVER BETTER PERFORMANCE!

2015 was marked by PEUGEOT's return to Rally-Raid, one of the most difficult motorsport disciplines in the world. To obtain the best performance in these trials, PEUGEOT Sport chose TOTAL QUARTZ for the PEUGEOT 2008 DKR, a lubricant of high technology which protects the engine in the most severe conditions.

### **TOTAL QUARTZ protects your engine against the effects of time.**

TOTAL QUARTZ Ineo First is a high performance lubricant, the result of work done together by PEUGEOT and TOTAL R&D. Specially formulated for the engines in PEUGEOT vehicles, its innovative technology significantly reduces CO<sub>2</sub> emissions and keeps your engine clean.

PEUGEOT RECOMMENDS TOTAL



OFFICIAL PARTNERS



# Bonnet

- !** Before doing anything under the bonnet, switch off the Stop & Start system to avoid any risk of injury resulting from an automatic change to START mode.

## Opening

- A. Interior release lever.
- B. Exterior safety catch.
- C. Bonnet stay.



- ☞ Open the left hand front door.
- ☞ Pull the release lever **A**, located at the bottom of the door aperture, towards you.

- i** The location of the interior release lever prevents opening of the bonnet when the left hand front door is closed.

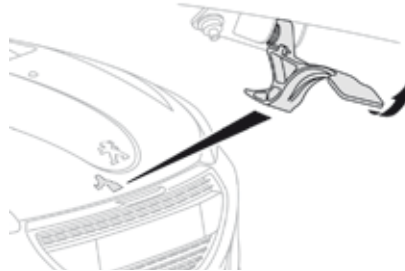

- ☞ Lift the safety catch **B** and raise the bonnet.

- !** Do not open the bonnet under very windy conditions. When the engine is hot, handle the exterior safety catch and the stay with care (risk of burns).

- !** Because of the presence of electrical equipment under the bonnet, it is recommended that exposure to water (rain, washing, ...) be limited.

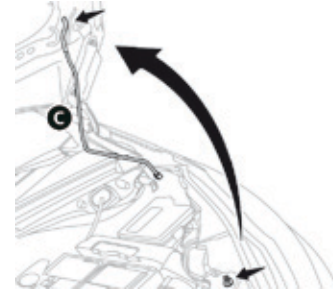

- ☞ Unclip the stay **C** from its housing and place it in the support slot to hold the bonnet open.

## Closing

- ☞ Take the stay **C** out of its support slot.
- ☞ Clip the stay back into its housing.



- ☞ Lower the bonnet and release it at the end of its travel.
- ☞ Pull the bonnet to check that it has latched correctly.

## Petrol

The various caps and covers allow access for checking the levels of the various fluids and for replacing certain components.

1. Screenwash reservoir.
2. Coolant header tank.
3. Brake fluid reservoir.
4. Battery / Fuses.
5. Fusebox.
6. Air filter.
7. Engine oil dipstick.
8. Engine oil filler cap.

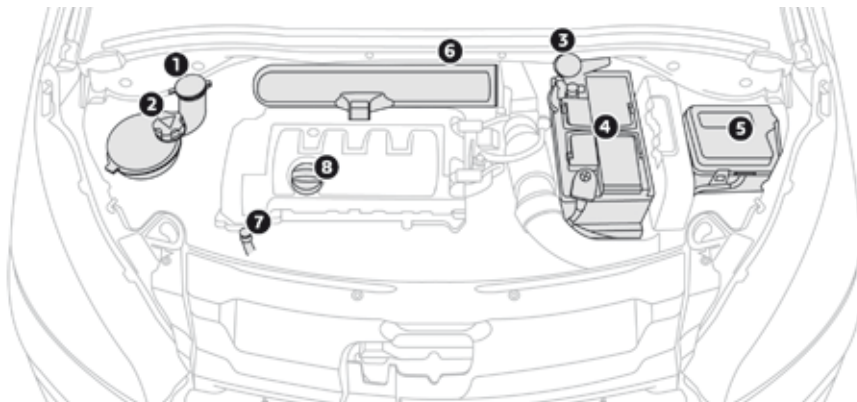

## Checking levels

Check the levels regularly, in line with the manufacturer's service schedule. Top them up if necessary, unless otherwise indicated. If a level drops significantly, have the corresponding system checked by a PEUGEOT dealer or a qualified workshop.

**!** Take care when working under the bonnet, as certain areas of the engine may be extremely hot (risk of burns) and the cooling fan could start at any time (even with the ignition off).

## Diesel

The various caps and covers allow access for checking the levels of the various fluids, for replacing certain components and for priming the fuel system.

1. Screenwash reservoir.
  2. Coolant header tank.
  3. Brake fluid reservoir.
  4. Battery / Fuses.
  5. Fusebox.
  6. Air filter.
  7. Engine oil dipstick.
  8. Engine oil filler cap.
  9. Priming pump (depending on engine).
- The AdBlue® additive tank filler is located in the boot below the spare wheel.

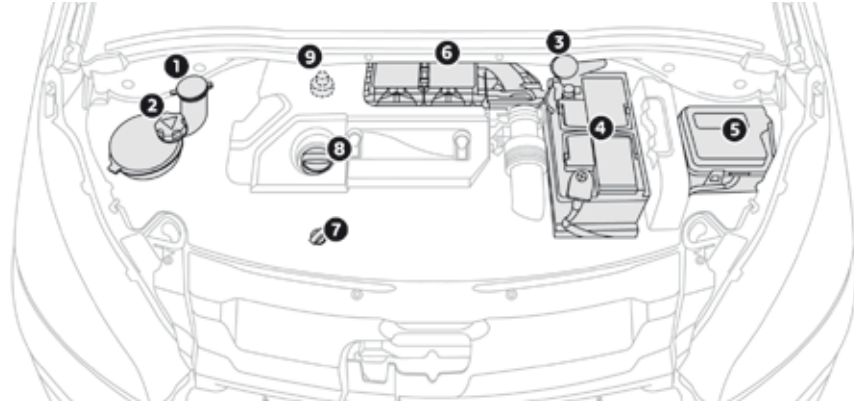

## Checking levels

Check the levels regularly, in line with the manufacturer's service schedule. Top them up if necessary, unless otherwise indicated.

If a level drops significantly, have the corresponding system checked by a PEUGEOT dealer or a qualified workshop.

**!** Take care when working under the bonnet, as certain areas of the engine may be extremely hot (risk of burns) and the cooling fan could start at any time (even with the ignition off).

## Checking levels

Check all of these levels regularly, in line with the manufacturer's service schedule. Top them up if necessary, unless otherwise indicated.

If a level drops significantly, have the corresponding system checked by a PEUGEOT dealer or a qualified workshop.

**!** Take care when working under the bonnet, as certain areas of the engine may be extremely hot (risk of burns) and the cooling fan could start at any time (even with the ignition off).

### Brake fluid

#### Level



The brake fluid level should be close to the "MAX" mark. If it is not, check the brake pad wear.

### Changing the fluid

Refer to the manufacturer's service schedule for details of the interval for this operation.

### Fluid specification

The brake fluid must conform to the manufacturer's recommendations.

### Oil level



The check is carried out either when the ignition is switched on using the oil level indicator in the instrument panel (depending on version), or using the dipstick.

It will only be correct if the vehicle is on level ground and the engine has been off for more than 30 minutes.

**i** It is normal to top up the oil level between two services (or oil changes). PEUGEOT recommends that you check the level, and top up if necessary, every 3 000 miles (5 000 km).

### Engine oil change

Refer to the manufacturer's service schedule for details of the interval for this operation. In order to maintain the reliability of the engine and emission control system, never use additives in the engine oil.

### Oil specification

The oil must be the correct grade for your engine and conform to the manufacturer's recommendations.

## Oil level

### Dipstick

For more information on the underbonnet and the engine oil dipstick, refer to the corresponding section.

There are 2 marks on the dipstick:



- **A** = max; never exceed this level,
- **B** = min; top up the level via the oil filler cap, using the grade of oil suited to your engine.

### Checking

- ☞ Open the bonnet and secure it with the stay.
- ☞ Pull the dipstick out and wipe it with a clean cloth.
- ☞ Return the dipstick to its tube and then pull it out again to check the level against the mark.
- ☞ Return the dipstick to its tube.

### Low oil level

- ☞ Identify the engine oil filler cap.
- ☞ Open the filler cap.
- ☞ Add engine oil with exceeding mark **A**.
- ☞ Fit the filler cap.



### Advice



Take care when working under the bonnet, as some parts of the engine can be very hot (risk of burns) and the cooling fan can start at any time (even with the ignition switched off).

If a level is found to be very low, have the corresponding system checked by a PEUGEOT dealer or a qualified workshop.

A check of the engine oil level is only valid if the vehicle is on level ground and the engine has been off for at least 30 minutes.

Oil grade: the oil used must meet the specification given in the manufacturer's servicing and warranty booklet.

## Electronic oil level indicator

The check is done for a few seconds after switching on the ignition, with a message in the display or screen (depending on version). It is only valid if the vehicle is on level ground and the engine has been off for at least 30 minutes.

**i** It is normal to top-up the engine oil level between services (or oil changes). PEUGEOT recommends that you check the oil level and top-up if necessary, every 3 000 miles (5 000 km).

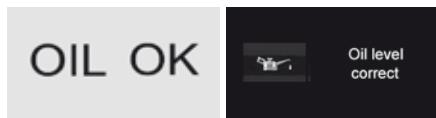

### Level correct

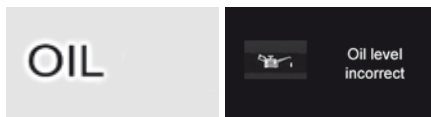

### Level incorrect

This is indicated by the flashing of "OIL" or by the display of a dedicated message in the instrument panel. If the low oil level is confirmed by a check using the dipstick, the level must be topped up to avoid damage to the engine.

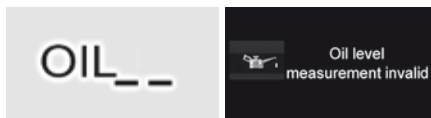

### Fault

This is indicated by the flashing of "OIL\_\_" or by the display of a dedicated message in the instrument panel. Contact a PEUGEOT dealer or a qualified workshop.

## Used products

**!** Avoid prolonged contact of used oil or fluids with the skin. Most of these fluids are harmful to health or indeed very corrosive.

**☘** Do not discard used oil or fluids into sewers or onto the ground. Take used oil to a PEUGEOT dealer or a qualified workshop (France) or to an authorised waste disposal site.

## Checks

Unless otherwise indicated, check these components in accordance with the manufacturer's service schedule and according to your engine. Otherwise, have them checked by a PEUGEOT dealer or a qualified workshop.

### Brake pads



Brake wear depends on the style of driving, particularly in the case of vehicles used in town, over short distances. It may be necessary to have the condition of the brakes checked, even between vehicle services.

Unless there is a leak in the circuit, a drop in the brake fluid level indicates that the brake pads are worn.

### Brake disc wear



For information on checking brake disc wear, contact a PEUGEOT dealer or a qualified workshop.



Only use products recommended by PEUGEOT or products of equivalent quality and specification. In order to optimise the operation of units as important as those in the braking system, PEUGEOT selects and offers very specific products. After washing the vehicle, dampness, or in wintry conditions, ice can form on the brake discs and pads: braking efficiency may be reduced. Make light brake applications to dry and defrost the brakes.

### Oil filter



Replace the oil filter each time the engine oil is changed. Refer to the manufacturer's service schedule for details of the replacement interval for this component.

### Air filter



Refer to the manufacturer's service schedule for details of the replacement intervals for this component.

Depending on the environment (e.g. dusty atmosphere) and the use of the vehicle (e.g. city driving), **replace it twice as often if necessary.**

A dirty air filter may restrict engine performance.

## BlueHDi and AdBlue® additive SCR technology



The objective of BlueHDi is to reduce by up to 90% the emissions of NOx (nitrous oxides) in the air, using a system that converts NOx into water vapour and nitrogen in a dedicated catalytic converter: SCR (Selective Catalytic Reduction).

This objective meets the "Euro 6" emissions standard adopted by the European Union aimed at limiting the emissions of pollutants from internal combustion engines.

The SCR technology used on BlueHDi engines involves the injection of AdBlue® fluid into the exhaust system.

### AdBlue®



AdBlue® is the brand name of the solution needed for operation of the SCR system.

BlueHDi vehicles have a specific AdBlue® additive tank with a **capacity of 17 litres**. Filling of the AdBlue® tank can be done using 5 or 10 litre containers or 1.89 litre bottles.



Check that the product is within its use-by date. Read the instructions on the label.

If you want to fill the AdBlue® tank yourself, ensure that you have a suitable filler pipe, which may or may not be supplied with the additive container.

This operation can also be carried out by a PEUGEOT dealer or a qualified workshop.



## Advice

While the quantity of AdBlue® in the additive tank is sufficient, no information is displayed. On the other hand, once the additive level drops to the quantity needed for a range of 1 500 miles (2 400 km) driving, you are warned by different temporary signals (warning lamp, message, audible signal).

When the AdBlue® tank is empty, restarting becomes impossible.



**!** It is strongly recommended that you do not wait for the successive alerts before topping-up the AdBlue® tank, but do this as soon as possible.

## Driving range



Press this button to display the information.

With the touch screen:

-  - select the "Driving assistance" menu,
-  - select "Diagnostic",
- CHECK** - select CHECK.

If the range is greater than 3 100 miles (5 000 km), a range value is not given.

## Range indicators



Different levels of alert are triggered according to the remaining driving range threshold. You will be informed as each mileage threshold is reached and the alerts will change from temporary to permanent.

- The 1<sup>st</sup> alert is triggered at a remaining driving range of 1 500 miles (2 400 km).
- The 2<sup>nd</sup> alert is triggered at a remaining driving range of 375 miles (600 km).

Up to 0 miles, at which point it will be impossible to restart the engine after a stop.

### Remaining range between 350 and 1500 miles (600 and 2 400 km)

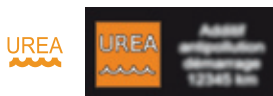

When switching on the ignition, this warning lamp comes on, accompanied by an audible signal and the display of a message (e.g.: "Top up emissions additive: Starting prevented in 900 miles") indicating the remaining range expressed in miles or kilometres.

When driving, the message is displayed every 200 miles (300 km) until the additive tank has been topped-up.

Go to a PEUGEOT dealer or a qualified workshop to have the AdBlue® tank topped-up. You can also top-up the tank yourself.

For more information on topping-up the AdBlue® additive, refer to the corresponding section.

### Remaining range between 0 and 350 miles (0 and 600 km)

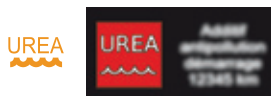

When switching on the ignition, this warning lamp flashes, accompanied by an audible signal and the display of a message (e.g. "Top up emissions additive: Starting prevented in 350 miles") indicating the remaining range expressed in miles or kilometres.

When driving, the message is displayed every 30 seconds until the additive tank has been topped-up.

Go to a PEUGEOT dealer or a qualified workshop to have the AdBlue® tank topped-up. You can also top-up the tank yourself.

Otherwise you will not be able to restart your engine.

### Breakdown related to a lack of AdBlue® additive



When switching on the ignition, this warning lamp flashes, accompanied by an audible signal and the display of the message "Top up emissions additive: Starting prevented". The AdBlue® tank is empty: the system required by regulations prevents engine starting.

**!** To be able to start the engine, we recommend that you call on a PEUGEOT dealer or a qualified workshop for the top-up required. If you carry out the top-up yourself, it is essential to add at least 3.8 litres of AdBlue® to the tank.

For more information on topping-up the AdBlue® additive, refer to the corresponding section.

## In the event of a fault with the SCR emissions control system

**!** A system that prevents engine starting is activated automatically from 650 miles (1 100 km) after confirmation of a fault with the SCR emissions control system. Have the system checked by a PEUGEOT dealer or a qualified workshop as soon as possible.

### In the event of the detection of a fault



These warning lamps come on, accompanied by an audible signal and the display of the message "Emissions fault".

The alert is triggered when driving when the fault is detected for the first time, then when switching on the ignition for subsequent journeys, while the fault persists.

**i** If it is a temporary fault, the alert disappears during the next journey, after self-diagnosis of the SCR system.

### During an authorised driving phase (between 650 miles and 0 miles) (1 100 km and 0 km)



If a fault with the SCR system is confirmed (after 30 miles (50 km) covered with the permanent display of the message signalling a fault), these warning lamps come on, accompanied by an audible signal and the display of a message (e.g.: "Emissions fault: Starting prevented in 150 miles") indicating the remaining range expressed in miles or kilometres. While driving, the message is displayed every 30 seconds while the fault with the SCR system persists. The alert is repeated when switching on the ignition.

You should go to a PEUGEOT dealer or a qualified workshop as soon as possible. Otherwise, you will not be able to restart your engine.

### Starting prevented



Every time the ignition is switched on, these warning lamps come on, accompanied by an audible signal and the display of the message "Emissions fault: Starting prevented".

**!** You have exceeded the authorised driving limit: the starting prevention system inhibits engine starting.

To be able to start the engine, you must call on a PEUGEOT dealer or a qualified workshop.

## Topping-up



### Precautions to take

Use only AdBlue® additive that meets the ISO 22241 standard.

The AdBlue® additive is an urea-based solution.

This liquid is non-flammable, colourless and odourless.

To be kept in a cool area.

In the event of an overflow, wipe around the filler mouth using a damp cloth.

- ! If any AdBlue® fluid is split or splashed on to you, wash immediately with cold water or wipe yourself with a clean damp cloth.
- If the additive has crystallised, clean it off using a sponge and hot water.

After filling the additive tank, observe the following procedure:

- Switch on the ignition without starting.
- Wait 10 seconds before starting the engine.



Never dispose of empty AdBlue® containers and bottles in the household waste.  
Place them in a special container provided for this purpose or take them to your dealer.

## Parking

Ensure that the vehicle is parked on a flat and level surface.

- ! In wintry conditions, ensure that the temperature of the vehicle is above -11°C. Otherwise, by freezing, the AdBlue® cannot be poured into its tank. Park your vehicle in a warmer area for a few hours to allow the top-up to be carried out.

- 🔑 Switch off the ignition and remove the key.

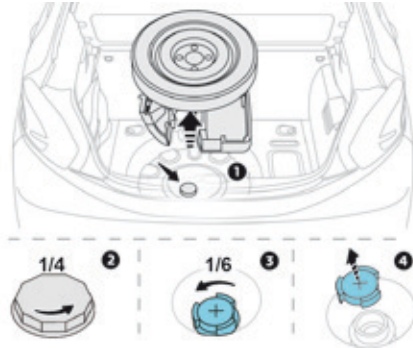

## Access

- ☞ For access to the AdBlue® tank, raise the boot carpet then, depending on equipment, lift out the spare wheel and/or the storage box.

## Opening

- ☞ Without pressing, turn the black cap a quarter turn anti-clockwise and lift it off.
- ☞ Turn the blue cap a 6<sup>th</sup> of a turn anti-clockwise.
- ☞ Lift off the cap.

## Filling

- ☞ Pour the contents of the bottle into your vehicle's AdBlue® tank.

**!** **Important:** if your vehicle's AdBlue® tank is completely empty - which is confirmed by the alert messages and the impossibility of starting the engine, you must add at least 3.8 litres (so two 1.89 litre bottles).

- ☞ Wipe away any spillage around the tank filler using a damp cloth.

**!** If any additive is split or splashed, wash immediately with cold water or wipe with a damp cloth.  
If the additive has crystallised, clean it off using a sponge and hot water.

## Closing

- ☞ Refit the blue cap to the tank and turn it a 6<sup>th</sup> of a turn clockwise, to its stop.
- ☞ Refit the black cap and turn it a quarter of a turn clockwise without pressing. Ensure that the indicator on the cap lines up with the indicator on the support.
- ☞ Depending on equipment, return the spare wheel and/or the storage box to the bottom of the boot.
- ☞ Refit the boot carpet and close the tailgate.

## Advice

**!** Important: **in the event of a top-up after a breakdown because of a lack of additive**, signalled by the message "Top up emissions additive: Starting prevented", you must wait around 5 minutes before switching on the ignition, **without opening the driver's door, locking the vehicle or introducing the key into the ignition switch.** Switch on the ignition, then, after 10 seconds, start the engine.

**!** Keep AdBlue® out of the reach of children, in its original container. Never transfer AdBlue® to another container: it would lose its purity. Never dilute the additive with water. Never pour the additive into the Diesel fuel tank.

**!** Never store containers or bottles of AdBlue® in your vehicle.

## Recommendations on storage

### **!** Freezing of the AdBlue® additive

AdBlue® freezes at about -11°C (12.2° F) and deteriorates above 25°C (77°F). It is recommended that containers and bottles be stored in a cool area and protected from direct sunlight. Under these conditions, the additive can be kept for at least a year. Additive that has been frozen can be used once it has thawed out in ambient air.

**i** The SCR system includes an AdBlue® tank heater that ensures operation of the vehicle in normal conditions. In exceptional situations, such as when the vehicle is kept at temperatures below -15°C (5°F) for a long period, there may be an emission fault alert related to freezing of the AdBlue® additive. Park the vehicle in an area at a more moderate temperature for a few hours until the additive becomes a liquid again. The emissions warning lamp does not go off immediately, but does so after a few miles of driving.

## Straight cut matt paint



The following recommendations should be taken into account in the care and maintenance of the matt paint. They also appear in the servicing and warranty booklet for the vehicle.

- Never clean the vehicle without water.
- Never clean your vehicle in an automatic roller-brush car wash.
- Never polish the body or the alloy wheels. This makes the paint bright.

- Do not use paint restorers, abrasive or polishing products or paint preservers (wax polish, for example) on the paintwork. These products are only suitable for bright finishes. Using them on vehicles finished with matt paint seriously damages the surface finish of the vehicle, resulting in particular in the appearance of irreversible bright or stained areas.
- Never use a high pressure jet washer fitted with a brush as this may scratch the paint surface.
- Never select a wash programme with a final hot wax cycle.

## Textured paint

The textured paint reacts to light with variations of appearance and finish that emphasise the car's lines and form. This paint contains particles that remain visible and create a unique satin effect with relief. Its lightly granulated texture gives it a surprising feel.

### Maintenance:

Observe the following recommendations to avoid damaging the paint finish:

- Choose a high pressure wash, or at least a high water delivery; roller brush washing is compatible.
- Gently wipe the body with a clean microfibre cloth.
- Carefully wipe off any fuel spilt on the body using a soft cloth, then allow to dry.
- Clean off minor marks (for example, finger marks), using the product in the "TECHNATURE" range intended for removing insects.

On the other hand:

- Do not use a wash programme that includes a final hot wax cycle.
- Do not use waterless cleaning.
- Never polish the vehicle.
- Do not use paint restorers, abrasive or polishing products, or bright paint preservers (wax polish, for example).

It is always preferable to have paint repairs carried out by a PEUGEOT dealer or a qualified workshop.

## Triangle

- ! Before leaving your vehicle to set up and install the triangle, switch on the hazard warning lamps and put on your high visibility vest.

### Placing the triangle in the road

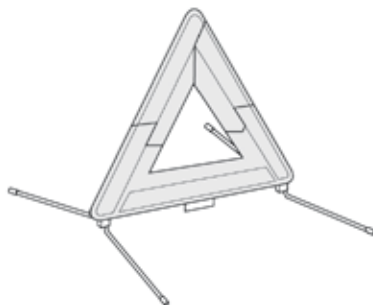

Refer to the manufacturer's instructions on using the triangle.

- ☞ Place the triangle behind the vehicle, as required by the legislation in force in your country.

- i The triangle is available as an accessory; contact a PEUGEOT dealer or a qualified workshop.



## Temporary puncture repair kit

The temporary puncture repair kit consists of a compressor and a sealant cartridge allowing the **temporary repair** of a tyre so that you can drive to the nearest garage.

It is designed to repair most punctures which could affect the tyre, located on the tyre tread or shoulder.

You can also use the compressor, without injection of sealant, to check and if necessary adjust the pressures of your tyres.

### Access to the kit

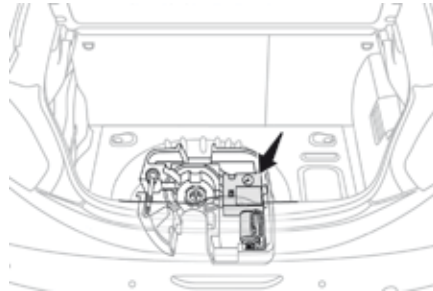

This kit is installed in the storage box, under the boot floor.

**i** The vehicle's electric system allows the connection of the compressor for long enough to inflate a tyre after a puncture repair.

### Composition of the kit

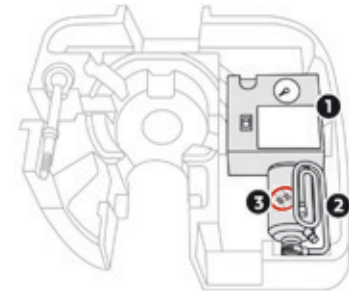

1. 12 V compressor, with integral pressure gauge.
2. Sealant cartridge, with integral hose.
3. Speed limit sticker.

**i** The speed limit sticker must be secured to the interior of the vehicle in the driver's field of vision, to remind you that a wheel is in temporary use.

**!** Do not exceed a speed of 50 mph (80 km/h) when driving with a tyre repaired using this type of kit.

## Repair



- ☞ Switch off the ignition.
- ☞ Secure the speed limit sticker inside the vehicle.

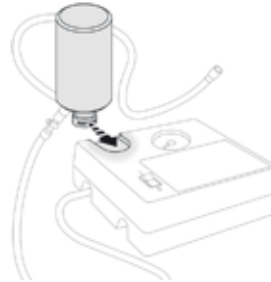

- ☞ Uncoil the pipe stowed under the compressor.
- ☞ Connect the pipe from the compressor to the sealant cartridge.
- ☞ Turn the sealant cartridge and secure it in the cut-out provided on the compressor.

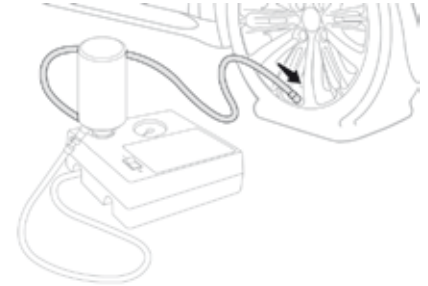

- ☞ Remove the valve cap from the tyre to be repaired, and place it in a clean area.
- ☞ Connect the hose from the sealant cartridge to the valve of the tyre to be repaired and tighten firmly.

**i** Avoid removing any foreign bodies which have penetrated into the tyre.

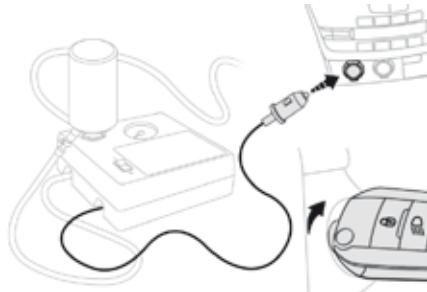

- ☞ Check that the compressor switch is at the "O" position.
- ☞ Uncoil fully the electric cable, stowed under the compressor.
- ☞ Connect the compressor's plug to the vehicle's 12 V socket.
- ☞ Switch on the ignition.

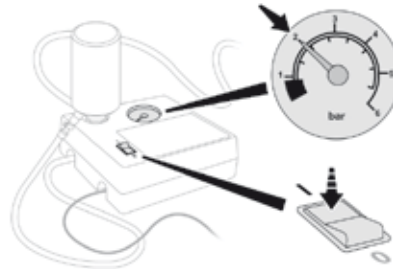

- ☞ Start the compressor by placing the switch at the "I" position and leave it running until the tyre pressure reaches 2.0 bar.  
The sealant product is injected into the tyre under pressure; do not disconnect the pipe from the valve during this operation (risk of splashing and stains).

**i** If after around 5 to 7 minutes the pressure is not attained, this indicates that the tyre is not repairable; contact a PEUGEOT dealer or a qualified workshop for assistance.

**!** Take care, the sealant product is harmful if swallowed and causes irritation to the eyes. Keep this product out of the reach of children. The use-by date is marked on the cartridge. After use, do not discard the cartridge by the roadside, take it to a PEUGEOT dealer or an authorised waste disposal site. Don't forget to obtain a new sealant cartridge, available from a PEUGEOT dealer or a qualified workshop.

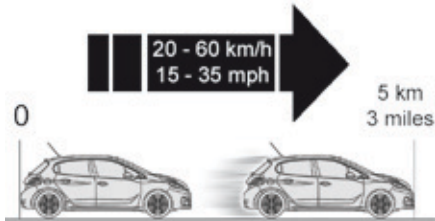

- ☞ Place the switch in the "O" position.
- ☞ Remove the kit.
- ☞ Drive immediately for approximately 3 miles (5 kilometres), at reduced speed (between 15 and 35 mph (20 and 60 km/h)), to plug the puncture.
- ☞ Stop to check the repair and the tyre pressure using the kit.

## Checking and inflating

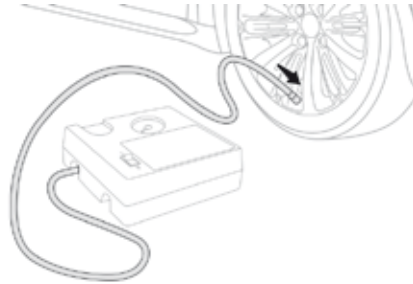

To check and if necessary adjust the tyre pressures:

- ☞ Remove the valve cap from the tyre and place it in a clean area.
- ☞ Uncoil the pipe stowed under the compressor.
- ☞ Screw the pipe onto the valve and tighten firmly.

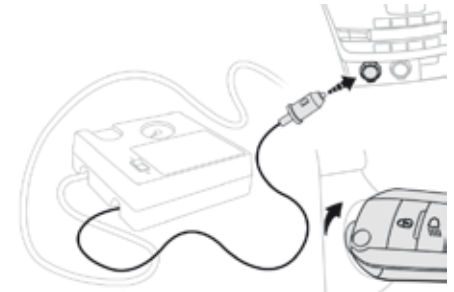

- ☞ Check that the compressor switch is at the "O" position.
- ☞ Uncoil fully the electric cable, stowed under the compressor.
- ☞ Connect the compressor's plug to the vehicle's 12 V socket.
- ☞ Switch on the ignition.

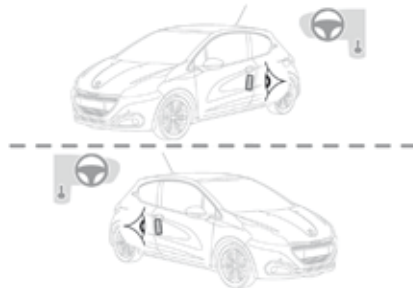

- ☞ Start the compressor by placing the switch at the "I" position and adjust the pressure to the value shown on the vehicle's tyre pressure label.  
To deflate: press the black button on the compressor pipe, at the valve connector.
- ☞ Once the correct pressure is reached, put the switch to the "O" position.
- ☞ Remove the kit then stow it.

**!** After using the kit, refer to the corresponding sections to check the tyre pressures and reinitialise the under-inflation detection system.

## Spare wheel

Procedure for changing a wheel for the spare wheel using the tools provided with the vehicle.

### Access to the tools



The tools are installed in the boot under the floor.

To gain access to them:

- 🔧 open the boot,
- 🔧 lift the floor and remove it,
- 🔧 remove the carrier box containing the tools.

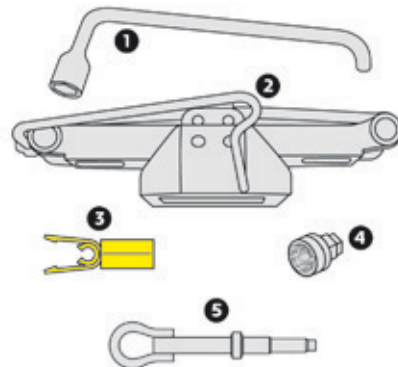

### List of tools\*

All of these tools are specific to your vehicle and can vary according to the level of equipment. Do not use them for other purposes.

1. Wheelbrace.  
For removing the wheel trim and removing the wheel bolts.
2. Jack with integral handle.  
For raising the vehicle.
3. "Bolt cover" tool.  
For removing the bolt protectors (covers) on alloy wheels.

4. Socket for the security bolts.  
For adapting the wheelbrace to the special "security" bolts.
5. Towing eye.  
See "Towing the vehicle".

\* Depending on country of sale.

### **i** Wheel with trim

**When refitting the wheel**, refit the trim starting by placing its notch facing the valve and press around its edge with the palm of your hand.

## Access to the spare wheel

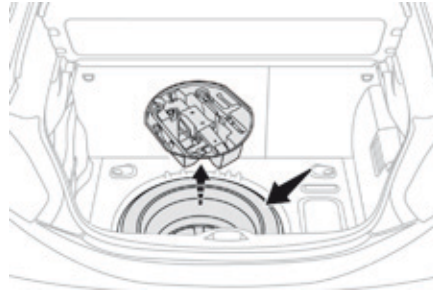

The spare wheel is installed in the boot under the floor.

According to country, the spare wheel may be steel, alloy or of the "space-saver" type.

To gain access to it, refer to the paragraph "Access to the tools" on the previous page.

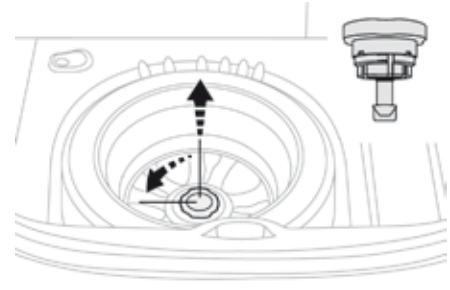

## Taking out the wheel

- ☞ Unscrew the yellow central bolt.
- ☞ Raise the spare wheel towards you from the rear.
- ☞ Take the wheel out of the boot.

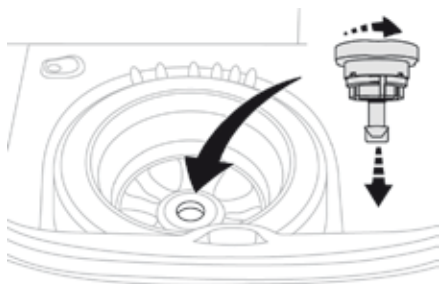

### Putting the wheel back in place

- ☞ Put the wheel back in its housing.
- ☞ Unscrew the yellow central bolt by a few turns then put it in place in the centre of the wheel.
- ☞ Tighten fully until the central bolt clicks to retain the wheel correctly.

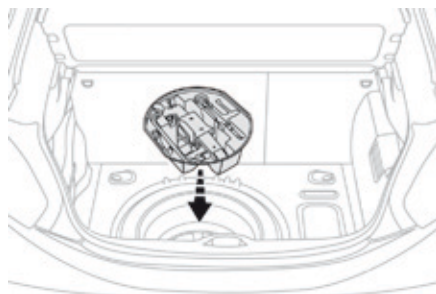

- ☞ Put the box back in the centre of the wheel and clip it in place.



## Removing a wheel

### i Parking the vehicle

Immobilise the vehicle where it does not block traffic: the ground must be level, stable and not slippery.

Apply the parking brake.

Switch off the ignition.

With a manual gearbox, engage first gear to block the wheels.

With an electronic gearbox, place the lever in position **R** to block the wheels.

With an automatic gearbox, place the lever in position **P** to block the wheels.

Check that the parking brake warning lamps in the instrument panel come on.

The occupants must get out of the vehicle and wait where they are safe.

Never go underneath a vehicle raised using a jack; use an axle stand.

### List of operations

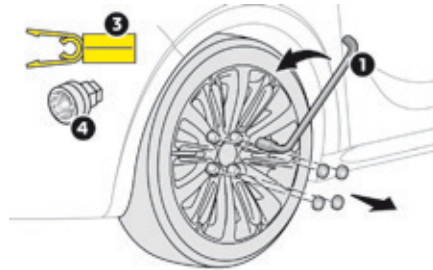

- ☞ Remove the bolt cover from each of the bolts using the tool **3** (according to equipment).
- ☞ Fit the security socket **4** on the wheelbrace **1** to slacken the security bolt (if fitted).
- ☞ Slacken the other bolts using the wheelbrace **1** only.



Never use:

- the jack for any other purpose than raising the vehicle,
- a jack other than the one provided by the manufacturer.

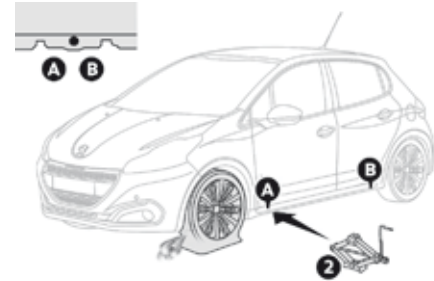

- ☞ Place the foot of the jack **2** on the ground and ensure that it is directly below the front **A** or rear **B** jacking point provided on the underbody, whichever is closest to the wheel to be changed.

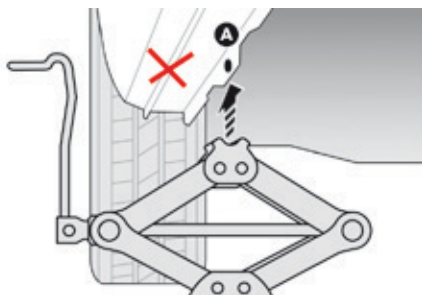

- ☞ Extend the jack **2** until it comes into contact with the jacking point **A** or **B** used; the contact area **A** or **B** on the vehicle must be correctly inserted into the central part of the head of the jack.

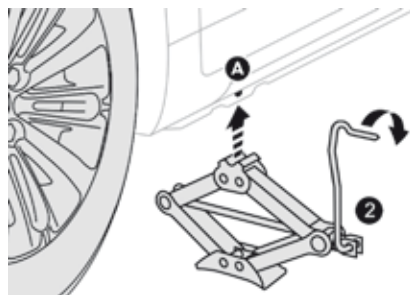

- ☞ Raise the vehicle until there is sufficient space between the wheel and the ground to admit the spare (not punctured) wheel easily.

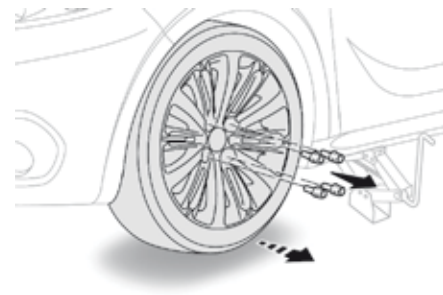

- ☞ Remove the bolts and store them in a clean place.
- ☞ Remove the wheel.

**!** Ensure that the jack is stable on a surface that is not slippery or loose and positioned only at the jacking point **A** or **B** under the vehicle, ensuring that the contact area on the vehicle is well centred on the head of the jack. Otherwise there is a risk of damage to the vehicle and/or of the jack dropping or slipping - Risk of injury!

## Fitting a wheel

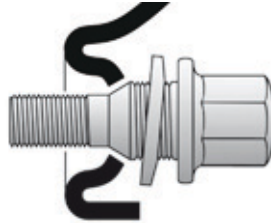

### **i** Fitting the spare wheel

If your vehicle is fitted with alloy wheels, when tightening the bolts on fitting, it is normal to notice that the washers do not come into contact with the spare wheel. The wheel is secured by the conical shoulder of each bolt (see drawing). When refitting the alloy wheel, ensure that the wheel bolt washers are clean and in good condition.

### **i** After changing a wheel

To store the punctured wheel in the boot correctly, first remove the central cover.

If your vehicle has a "standard" 15-inch spare wheel, do not exceed 50 mph (80 km/h).

If your vehicle is fitted with 16 or 17-inch wheels, use the "space-saver" type spare wheel and do not exceed 50 mph (80 km/h).

Have the tightening of the bolts and the pressure of the spare wheel checked by a PEUGEOT dealer or a qualified workshop without delay.

Have the punctured tyre repaired and the wheel refitted to the vehicle as soon as possible.

## List of operations

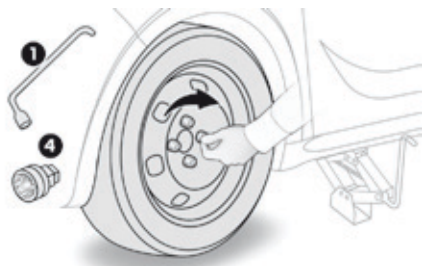

- ☞ Put the wheel in place on the hub.
- ☞ Screw in the bolts fully by hand.
- ☞ Pre-tighten the security bolt using the wheelbrace 1 fitted with the security socket 4 (if your vehicle has them).
- ☞ Pre-tighten the other bolts using the wheelbrace 1 only.

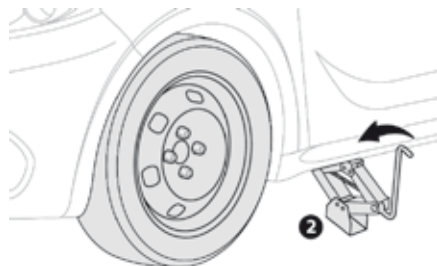

- ☞ Lower the vehicle fully.
- ☞ Fold the jack 2 and detach it.

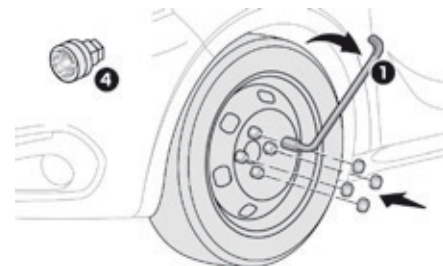

- ☞ Tighten the security bolt using the wheelbrace 1 fitted with the security socket 4 (if your vehicle has them).
- ☞ Tighten the other bolts using the wheelbrace 1 only.
- ☞ Refit the bolt covers on each of the bolts (according to equipment).
- ☞ Store the tools in the box.

## Changing a bulb

- !** The headlamps have polycarbonate lenses with a protective coating:
- ☞ **do not clean them using a dry or abrasive cloth, nor with a detergent or solvent product,**
  - ☞ use a sponge and soapy water or a pH neutral product,
  - ☞ when using a high pressure washer on persistent marks, do not keep the lance directed towards the lamps or their edges for too long, so as not to damage their protective coating and seals.

- i** Changing a bulb should only be done after the headlamp has been switched off for several minutes (risk of serious burns).
- ☞ Do not touch the bulb directly with your fingers, use a lint-free cloth.
- It is imperative to use only anti-ultraviolet (UV) type bulbs to avoid damaging the headlamp. Always replace a failed bulb with a new bulb with the same type and specification.

### Front lamps

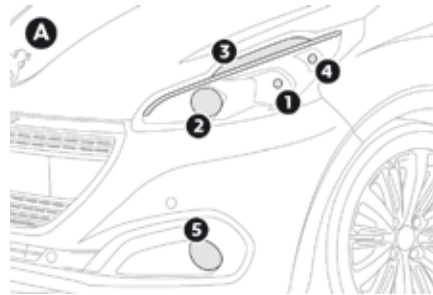

#### A. Model with light guide

1. Main beam headlamps (H7-55W).
2. Dipped beam headlamps (H7-55W).
3. Daytime running lamps / sidelamps (light emitting diodes - LEDs).
4. Direction indicators (PWY-24W).
5. Front foglamps (directional according to version) (H11-55W).

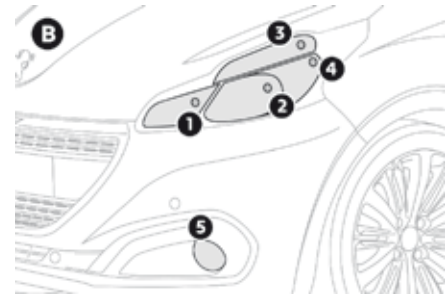

#### B. Model without light guide

1. Main beam headlamps (H7-55W).
2. Dipped beam headlamps (H7-55W).
3. Daytime running lamps / sidelamps (W5-5W).
4. Direction indicators (PWY-24W).
5. Front foglamps (directional according to version) (H11-55W).

- i** In some weather conditions (e.g. low temperature or humidity), the presence of misting on the internal surface of the glass of the headlamps and rear lamps is normal; it disappears after the lamps have been on for a few minutes.

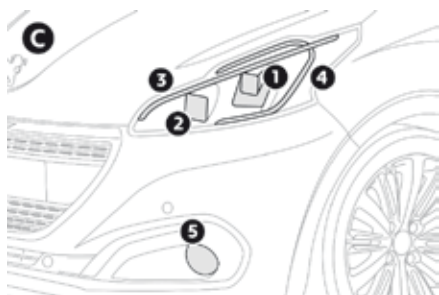

### C. GTi model

1. Main beam headlamps (H7-55W).
2. Dipped beam headlamps (H7-55W).
3. Daytime running lamps / sidelamps (light-emitting diodes - LEDs).
4. Direction indicators (light-emitting diodes - LEDs).
5. Front foglamps (directional according to version) (H11-55W).

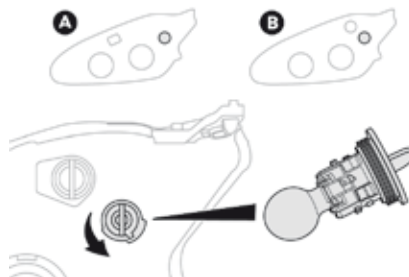

### Changing direction indicator bulbs

**i** Rapid flashing of the direction indicator warning lamp (right or left) indicates the failure of a bulb on that side.

- ☞ Turn the bulb holder a quarter of a turn and extract it.
- ☞ Pull out the bulb and change it.

To reassemble, carry out these operations in reverse order.

**i** Amber coloured bulbs, such as the direction indicators, must be replaced with bulbs of identical specifications and colour. When refitting, close the protective cover carefully to preserve the sealing of the headlamp.

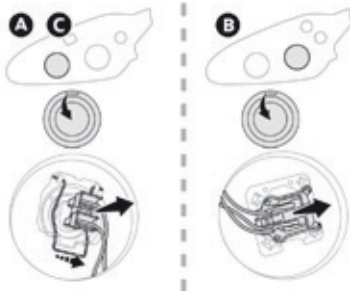

### Changing dipped beam headlamp bulbs

- ☞ Remove the protective cover by pulling on the tab.
- ☞ Disconnect the bulb connector.
- ☞ Spread the spring to release the bulb (model A).
- ☞ Extract the bulb and change it.

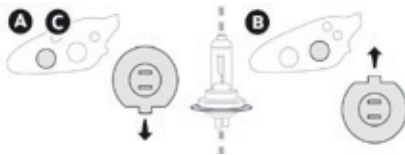

To reassemble, carry out these operations in reverse order, positioning the alignment lug at the bottom (model A) or at the top (model B).

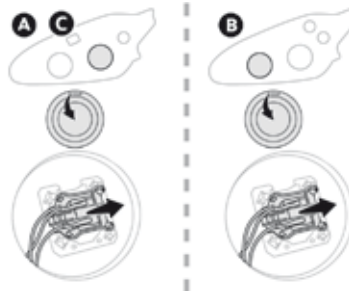

### Changing main beam headlamp bulbs

- ☞ Disconnect the main headlamp connector.
- ☞ Remove the protective cover by pulling on the tab.
- ☞ Disconnect the bulb connector.
- ☞ Pull out the bulb and replace it.

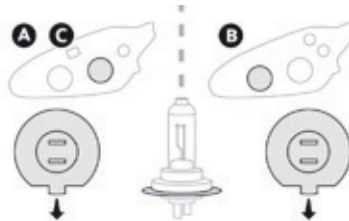

To reassemble, carry out these operations in reverse order, positioning the alignment lug at the bottom.

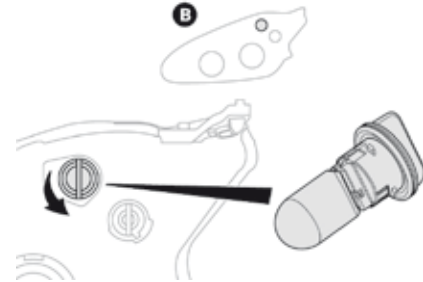

### Changing daytime running lamp / sidelamp bulbs

- ☞ Turn the bulb holder a quarter turn and pull it out.
  - ☞ Pull out the bulb and replace it.
- To reassemble, carry out these operations in reverse order.

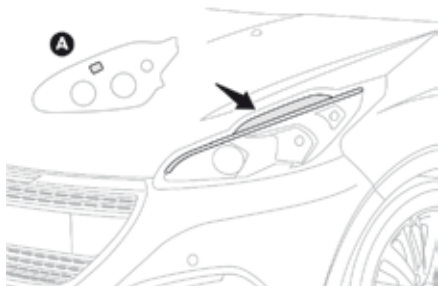

### Changing the daytime running lamps / sidelamps (light-emitting diodes - LEDs)

For the replacement of this type of LED lamp, contact a PEUGEOT dealer or a qualified workshop.

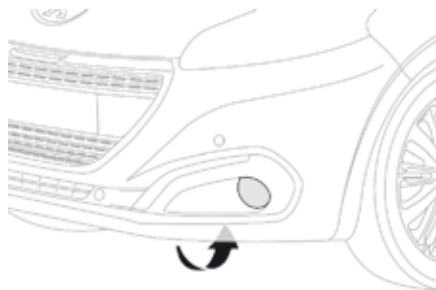

### Changing front foglamp / directional lamps

- ☞ Access to the front foglamp is through the orifice below the bumper.
- ☞ Disconnect the bulb holder connector by pressing on the top of the tongue.
- ☞ Extract the bulb holder by pressing on the two clips (top and bottom).
- ☞ Replace the module.

**i** To reassemble, carry out these operations in reverse order.  
To obtain this module, contact a PEUGEOT dealer or a qualified workshop.  
You can also contact a PEUGEOT dealer or a qualified workshop for this replacement.



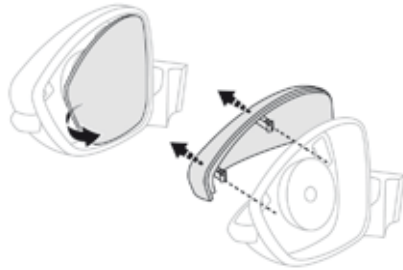

### Changing integrated direction indicator side repeater bulbs

- ☞ Insert a flat screwdriver between the mirror glass and its base.
- ☞ Use the screwdriver as a lever to extract the mirror glass.
- ☞ Unclip the mirror shell by pressing on the two retaining clips.

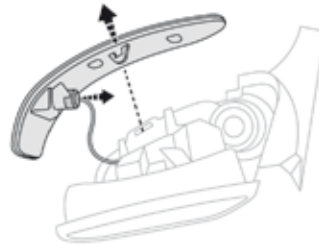

- ☞ Press the central tongue and remove the side repeater.
- ☞ Pull the bulb holder out and replace the failed bulb.

**i** To reassemble, carry out these operations in reverse order. You should contact a PEUGEOT dealer or a qualified workshop for the replacement of these bulbs.

### Rear lamps

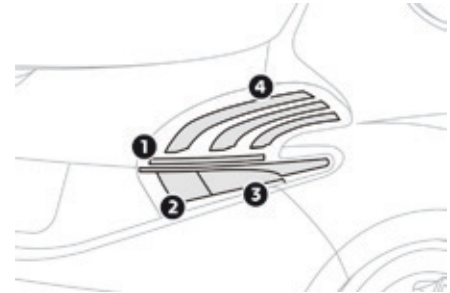

1. Brake lamps (light-emitting diodes - LEDs).
2. Reversing lamps (P21W).
3. Direction indicators (PY21W amber).
4. Sidelamps (light-emitting diodes - LEDs).

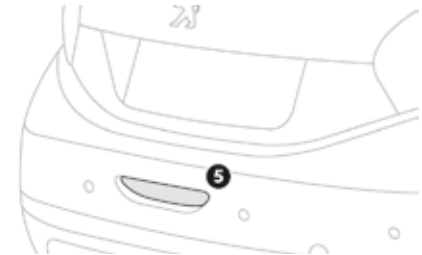

5. Foglamp (P21W).

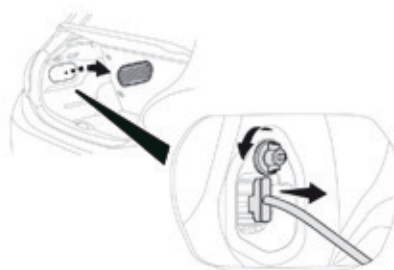

## Light-emitting diodes - LEDs

**i** For replacement, contact a PEUGEOT dealer or qualified workshop.

## Changing reversing lamp and direction indicator bulbs

These two bulbs are changed from inside the boot:

- ☞ Open the boot.
- ☞ Remove the access grille from the corresponding side trim panel.
- ☞ Slacken and remove the nut.
- ☞ Disconnect the lamp unit connector.
- ☞ Unclip the lamp unit carefully extract it pulling in line towards the outside.

- ☞ Press the four tabs and remove the bulb holder.
- ☞ Turn the bulb a quarter of a turn and change it.

To reassemble, carry out these operations in reverse order.

Take care to engage the lamp unit in its guides, while keeping it in line with the vehicle. Tighten sufficiently to ensure sealing, but without damaging the lamp.

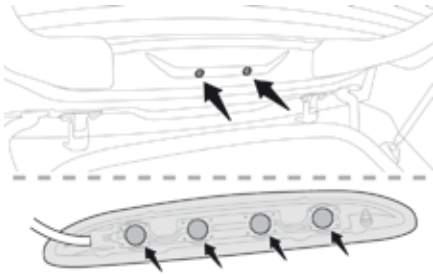

### Changing the third brake lamp bulbs

- ☞ Unscrew the fixing pins on each side of the lamp, without removing them completely.
- ☞ Push on the screws to unclip the lamp.
- ☞ Disconnect the lamp connector.
- ☞ Remove the lamp from the outside.
- ☞ Turn the bulb holder which corresponds to the faulty bulb one quarter of a turn and remove it.
- ☞ Pull the bulb and change it.

To refit, carry out these operations in reverse order.

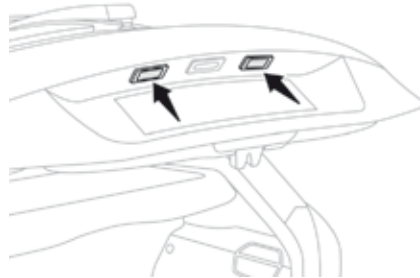

### Number plate lamps

To facilitate the removal of the lamp, carry out this operation with the tailgate half open.

- ☞ Insert a thin screwdriver into the lens cutout.
- ☞ Push it outwards.
- ☞ Remove the lens.
- ☞ Change the faulty bulb.

To refit, press on the lens to clip it in place.

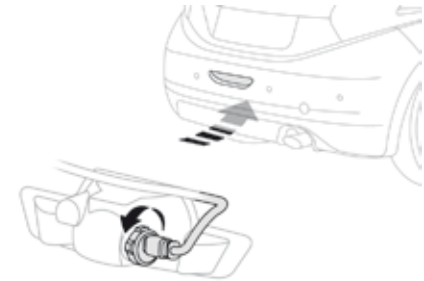

### Changing a foglamp bulb

Access is by passing a hand under the bumper.

- ☞ Turn the bulb holder a quarter of a turn and pull it out.
- ☞ Disconnect the connector on the bulb holder.
- ☞ Pull the bulb out and change it.

To refit, carry out these operations in reverse order.

You can also contact a PEUGEOT dealer or a qualified workshop for the replacement of these bulbs.

## Fuses

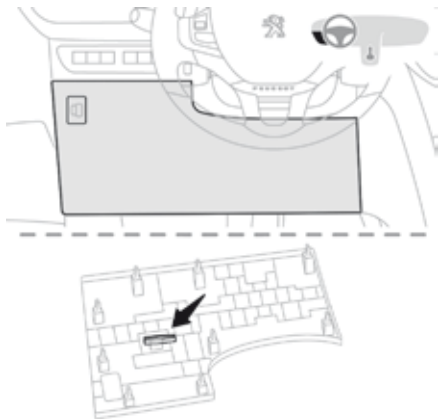

### Access to tools

The extraction tweezers is fitted to the back of the dashboard or glove box fusebox cover.

For the dashboard:

- ☞ Unclip the cover by pulling at the top left, then right.
- ☞ Disengage the cover completely and turn it over.
- ☞ Remove the carrier on which the tweezers is fitted.

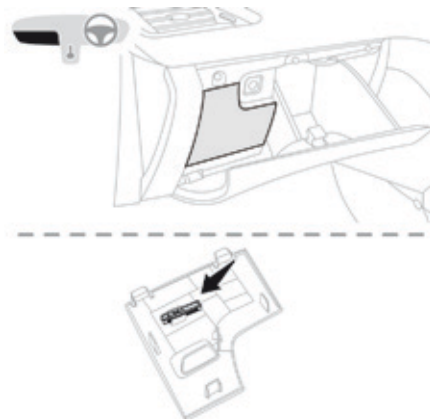

For the glove box:

- ☞ Open the glove box lid.
- ☞ Unclip the fusebox cover by pulling at top right.
- ☞ Disengage the cover fully and turn it over.
- ☞ Remove the back of the carrier on which the tweezers is fitted.

Before changing a fuse:

- ☞ the vehicle must be immobilised with the ignition off,
- ☞ all electrical consumers must be switched off,
- ☞ identify the failed fuse using the tables and layout drawings in the following pages.



Good

Failed



Tweezer

To replace a fuse, you must:

- ☞ use the special tweezers to extract the fuse from its housing and check the condition of its filament.
- ☞ always replace the failed fuse with a fuse of the same rating (same colour); using a different rating could cause faults (risk of fire).

If the fuse fails again soon after replacement, have the vehicle's electrical system checked by a PEUGEOT dealer or a qualified workshop.

**i** Professional repairers: for full information on the fuses and relays, consult the wiring information and diagrams available at a PEUGEOT dealer.

**!** The replacement of a fuse not shown in the tables below may cause a serious malfunction of your vehicle. Contact a PEUGEOT dealer or a qualified workshop.

## **i** Installing electrical accessories

Your vehicle's electrical system is designed to operate with standard or optional equipment. Before installing other electrical equipment or accessories on your vehicle, contact a PEUGEOT dealer or a qualified workshop.

**!** PEUGEOT will not accept responsibility for the cost incurred in repairing your vehicle or for rectifying malfunctions resulting from the installation of accessories not supplied and not recommended by PEUGEOT and not installed in accordance with its instructions, in particular when the combined consumption of all of the additional equipment connected exceeds 10 milliamperes.

## On the left

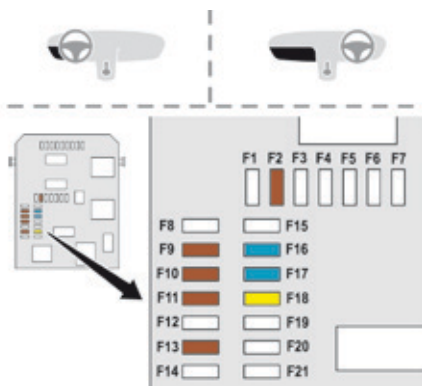

Fuse N°	Rating	Functions
F2	5 A	Door mirrors, headlamps, diagnostic socket.
F9	5 A	Alarm.
F10	5 A	Independent telematic unit, trailer interface.
F11	5 A	Electrochrome rear view mirror, additional heating.
F13	5 A	Hi-Fi amplifier, parking sensors
F16	15 A	Front 12 V socket.
F17	15 A	Audio system, audio system (accessory).
F18	20 A	Touch screen.

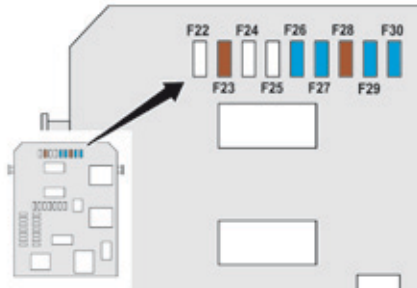

Fuse N°	Rating	Functions
F23	5 A	Vanity mirror, map reading lamps.
F26	15 A	Horn.
F27	15 A	Screenwash pump.
F28	5 A	Anti-theft.
F29	15 A	Air conditioning compressor.
F30	15 A	Rear wiper.

## On the right

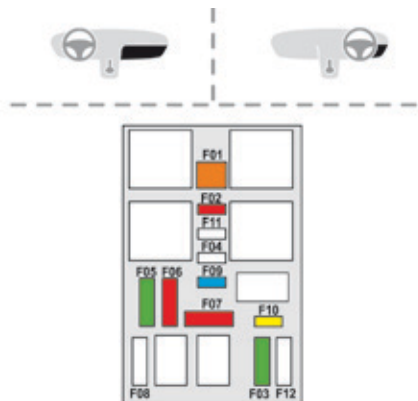

Fuse N°	Rating	Functions
F01	40 A	Heated rear window.
F02	10 A	Heated door mirrors.
F03	30 A	Front one-touch windows.
F04	-	Not used.
F05	30 A	Rear one-touch windows.
F06	10 A	Folding door mirrors.
F07	10 A	Folding door mirrors.
F08	-	Not used.
F09	15 A	Front heated seats.
F10	20 A	Hi-Fi amplifier.
F11	-	Not used.
F12	-	Not used.



## Engine compartment

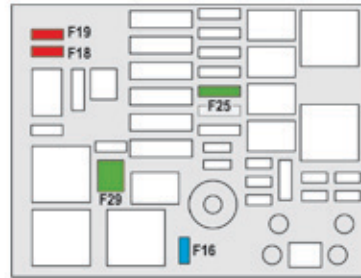

The fusebox is placed in the engine compartment near the battery (left-hand side).

### Access to the fuses

- ☞ Unclip the cover.
- ☞ Change the fuse (see corresponding paragraph).
- ☞ When you have finished, close the cover carefully to ensure correct sealing of the fusebox.

Fuse N°	Rating	Functions
F16	15 A	Front foglamps.
F18	10 A	Right hand main beam headlamp.
F19	10 A	Left hand main beam headlamp.
F25	30 A	Headlamp wash relay (accessory).
F29	40 A	Front wiper motor.

## 12 V battery

Procedure for starting the engine using another battery or charging a discharged battery.

### General points

#### Lead-acid starter batteries



Batteries contain harmful substances such as sulphuric acid and lead. They must be disposed of in accordance with regulations and must not, in any circumstances, be discarded with household waste. Take used remote control batteries and vehicle batteries to a special collection point.



Versions equipped with Stop & Start are fitted with a 12 V lead-acid battery of specific technology and specification. Its replacement should be carried out only by a PEUGEOT dealer or a qualified workshop.



Protect your eyes and face before handling the battery. All operations on the battery must be carried out in a well ventilated area and away from naked flames and sources of sparks, so as to avoid the risk of explosion or fire. Wash your hands afterwards.



If your vehicle has an electronic gearbox, do not try to start the engine by pushing the vehicle.



If your vehicle has an automatic gearbox, do not try to start the engine by pushing the vehicle.

### Access to the battery

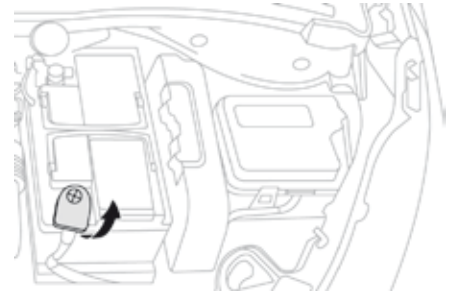

The battery is located under the bonnet.

To gain access to it:

- ☞ open the bonnet using the interior release lever, then the exterior safety catch,
- ☞ secure the bonnet stay,
- ☞ remove the plastic cover on the (+) terminal.

The (-) terminal of the battery is not accessible. A remote earth point is located on the engine.

## Starting using another battery

When your vehicle's battery is discharged, the engine can be started using a slave battery (external or on another vehicle) and jump lead cables or a battery booster.

**!** Never try to start the engine by connecting a battery charger. Never use a 24 V or higher battery booster.

First check that the slave battery has a nominal voltage of 12 V and a capacity at least equal to that of the discharged battery.

The two vehicles must not be in contact with each other.

Switch off the electrical consumers on both vehicles (audio system, wipers, lighting, ...).

Ensure that the jump lead cables do not pass close to moving parts of the engine (cooling fan, belts, ...).

Do not disconnect the (+) terminal when the engine is running.

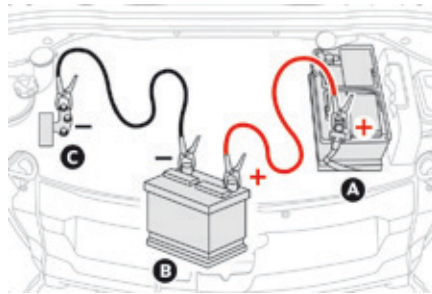

- ☞ Raise the plastic cover on the (+) terminal, if your vehicle has one.
- ☞ Connect the red cable to the positive terminal (+) of the flat battery **A** (at the metal elbow) then to the positive terminal (+) of the slave battery **B** or the booster.
- ☞ Connect one end of the green or black cable to the negative terminal (-) of the slave battery **B** or the booster (or earth point on the other vehicle).
- ☞ Connect the other end of the green or black cable to the earth point **C** on the broken down vehicle.

- ☞ Start the engine of the vehicle with the good battery and leave it running for a few minutes.
- ☞ Operate the starter on the broken down vehicle and let the engine run. If the engine does not start straight away, switch off the ignition and wait a few moments before trying again.
- ☞ Wait until the engine returns to idle then disconnect the jump lead cables in the reverse order.
- ☞ Refit the plastic cover to the (+) terminal, if your vehicle has one.
- ☞ Allow the engine to run for at least 30 minutes, by driving or with the vehicle stationary, so that the battery reaches an adequate state of charge.

**i** Some functions, including Stop & Start, are not available if the battery is not sufficiently charged.

## Charging the battery using a battery charger

For optimum service life of the battery, it is essential to maintain an adequate state of charge.

In some circumstances it may be necessary to charge the battery:

- if you use your vehicle essentially for short journeys,
- if the vehicle is to be taken off the road for several weeks.

Contact a PEUGEOT dealer or a qualified workshop.

**!** If you envisage charging your vehicle's battery yourself, use only a charger compatible with lead-acid batteries of a nominal voltage of 12 V.

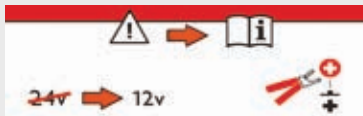

If this label is present, it is essential to use only a 12 V charger, to avoid causing irreversible damage to the electrical components related to the Stop & Start system.

**!** Follow the instructions for use provided by the manufacturer of the charger. Never reverse polarities.

**i** It is not necessary to disconnect the battery.

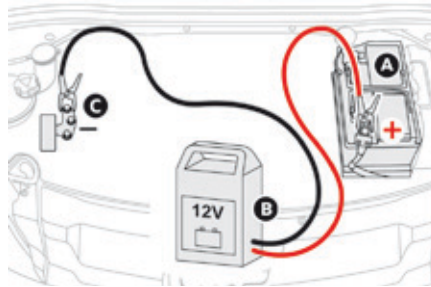

- ☞ Switch off the ignition.
- ☞ Switch off all electrical consumers (audio system, lighting, wipers, ...).
- ☞ Switch off the charger **B** before connecting the cables to the battery, so as to avoid any dangerous sparks.
- ☞ Ensure that the charger cables are in good condition.

- ☞ Raise the plastic cover, if your vehicle has one, on the (+) terminal.
- ☞ Connect the charger **B** cables as follows:
  - the positive (+) red cable to the (+) terminal of the battery **A**,
  - the negative (-) black cable to the earth point **C** on the vehicle.
- ☞ At the end of the charging operation, switch off the charger **B** before disconnecting the cables from the battery **A**.

**!** Never try to charge a frozen battery. If the battery has been frozen, have it checked by a PEUGEOT dealer or a qualified workshop, who will check that the internal components have not been damaged and the casing is not cracked, which could cause a leak of toxic and corrosive acid.

## Disconnecting the battery

It is recommended that the battery be disconnected if the vehicle is not to be used for a very long period, so as to maintain an adequate state of charge for starting the engine.

Before disconnecting the battery:

- ☞ close all openings (doors, boot, windows, roof),
- ☞ switch off all electrical consumers (audio system, wipers, lighting...),
- ☞ switch off the ignition and then wait four minutes.

At the battery, simply detach the (+) terminal.

## Quick-release terminal

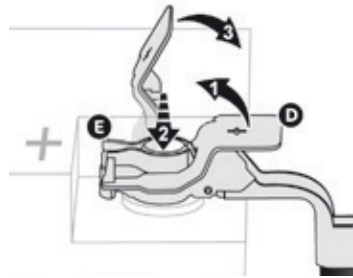

## Disconnecting the (+) cable

- ☞ Raise the lever **D** fully to release the cable terminal clamp **E**.

## Reconnecting the (+) cable

- ☞ Position the open clamp **E** of the cable on the positive post (+) of the battery.
- ☞ Press vertically on the clamp **E** to position it correctly on the battery.
- ☞ Lock the clamp by spreading the positioning lug and then lowering the lever **D**.



Do not apply excessive force on the tab as locking will not be possible if the clamp is not positioned correctly; start the procedure again.

## Following reconnection of the battery

Following reconnection of the battery, switch on the ignition and wait 1 minute before starting to permit initialisation of the electronic systems. However, if problems remain following this operation, contact a PEUGEOT dealer or a qualified workshop.

Referring to the corresponding section, you must yourself reinitialise (depending on version):

- the remote control key,
- ...



The Stop & Start system may not be operational during the trip following the first engine start.

In this case, the system will only be available again after a continuous period of immobilisation of the vehicle, a period which depends on the ambient temperature and the state of charge of the battery (up to about 8 hours).

## Towing

Procedure for having your vehicle towed or for towing another vehicle using a removable towing eye.

### Access to the tools

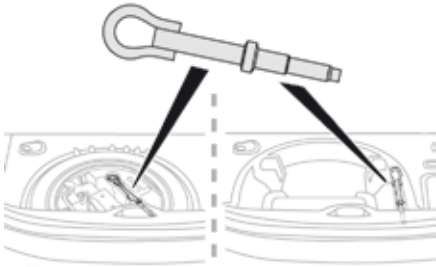

The towing eye is installed in the boot under the floor.

To gain access to it:

- ☞ open the boot,
- ☞ lift the floor and remove it,
- ☞ remove the towing eye from the holder.

### ! General recommendations

Observe the legislation in force in your country.

Ensure that the weight of the towing vehicle is higher than that of the towed vehicle.

The driver must remain at the wheel of the towed vehicle and must have a valid driving licence.

When towing a vehicle with all four wheels on the ground, always use an approved towing arm; rope and straps are prohibited. The towing vehicle must move off gently.

When towing a vehicle with the engine off, there is no longer any power assistance for braking or steering.

In the following cases, you must always call on a professional recovery service:

- vehicle broken down on a motorway or fast road,
- four-wheel drive vehicle,
- when it is not possible to put the gearbox into neutral, unlock the steering, or release the parking brake,
- towing with only two wheels on the ground,
- where there is no approved towing arm available...



## Being towed

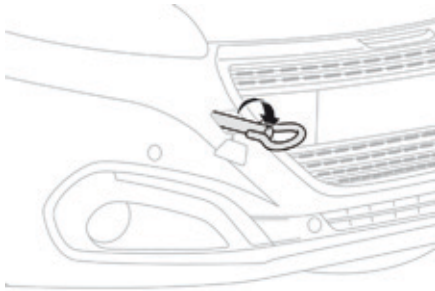

- ☞ In the front bumper, unclip the cover by pressing at bottom right.
- ☞ Screw the towing eye in fully.
- ☞ Install the towing arm.
- ☞ With a manual gearbox, place the gear lever in neutral.

- i** ☞ With an electronic gearbox, place the gear lever in position **N**.
  - ☞ With an automatic gearbox, place the gear lever in position **N**.
- Failure to observe this instruction could result in damage to certain components (braking, transmission...) and the absence of braking assistance the next time the engine is started.
- ☞ Unlock the steering by turning the key in the ignition one notch and release the parking brake.

- ☞ Switch on the hazard warning lamps on both vehicles.
- ☞ Move off gently, drive slowly and for a short distance only.

## Towing another vehicle

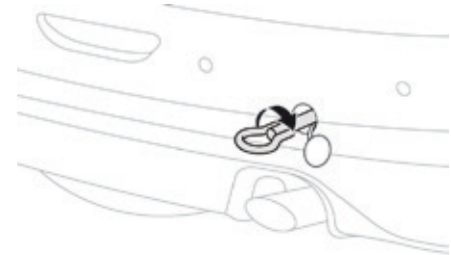

- ☞ On the rear bumper, unclip the cover by pressing at the bottom.
- ☞ Screw the towing eye in fully.
- ☞ Install the towing arm.
- ☞ Switch on the hazard warning lamps on both vehicles.
- ☞ Move off gently, drive slowly and for a short distance.

## Running out of fuel (Diesel)

On vehicles fitted with Diesel engines, the fuel system must be primed if you run out of fuel. For all versions other than BlueHDi, refer to the corresponding engine compartment view.

**i** For more information on the Diesel misfuel prevention device, refer to the corresponding section.

**!** If the engine does not start first time, don't keep trying but start the procedure again from the beginning.

### BlueHDi engine

- ☞ Add at least 5 litres of Diesel to the fuel tank.
- ☞ Switch on the ignition (without starting the engine).
- ☞ Wait around 6 seconds and switch off the ignition.
- ☞ Repeat the operation 10 times.
- ☞ Operate the starter to run the engine.

### 1.6 HDi engine

#### (except BlueHDi)

- ☞ Add at least 5 litres of Diesel to the fuel tank.
- ☞ Open the bonnet.
- ☞ If necessary, unclip the styling cover for access to the priming pump.
- ☞ Squeeze and release the priming pump repeatedly until resistance is felt (there may be resistance at the first press).
- ☞ Operate the starter to start the engine (if the engine does not start at the first attempt, wait around 15 seconds before trying again).
- ☞ If the engine does not start after a few attempts, operate the priming pump again then start the engine.
- ☞ Refit the styling cover and clip it in place.
- ☞ Close the bonnet.

### Other engines

- ☞ Add at least 5 litres of Diesel to the fuel tank.
- ☞ Open the bonnet.
- ☞ If necessary, unclip the styling cover for access to the priming pump.
- ☞ Squeeze and release the priming pump repeatedly until resistance is felt (there may be resistance at the first press).
- ☞ Operate the starter to start the engine (if the engine does not start at the first attempt, wait around 15 seconds before trying again).
- ☞ If the engine does not start after a few attempts, operate the priming pump again then start the engine.
- ☞ Refit the styling cover and clip it in place.
- ☞ Close the bonnet.



## General information

### Engine characteristics

The engine characteristics (capacity, maximum power, maximum power speed, fuel, CO<sub>2</sub> emissions...) for your vehicle are given in the registration document, as well as in sales brochures.

These characteristics correspond to the values type-approved on a test bed, under conditions defined in European legislation (Directive 1999/99/EC).

For more information, contact a PEUGEOT dealer or a qualified workshop.

### Weights and towed loads

The maximum weights and towed loads for your vehicle are given in the registration document, as well as in sales brochures.

These values are also present on the manufacturer's plate or label.

For more information on these identification markings, refer to the corresponding section.

For further information, contact a PEUGEOT dealer or a qualified workshop.

The kerb weight is equal to the unladen weight + driver (75 kg).

The gross train weight and towed load values indicated apply up to a maximum altitude of 1 000 metres; the towed load mentioned must be reduced by 10 % for every additional 1 000 metres.

The weight of the braked trailer can be increased, within the GTW limit, on condition that the GVW of the towing vehicle is reduced by the same amount.

The recommended nose weight is the vertical load on the towball (removable with or without tools).

**GVW:** gross vehicle weight, the maximum authorised vehicle weight.

**GTW:** gross train weight, the maximum authorised weight of vehicle plus trailer.

**i** High ambient temperatures may result in a reduction in the performance of the vehicle to protect the engine; when the ambient temperature is higher than 37 °C, limit the towed weight.

**!** Towing with a lightly loaded vehicle can adversely affect roadholding. Braking distances are increased when towing a trailer. Never exceed 60 mph (100 km/h) when towing (comply with the legislation in force in your country).

## Petrol engines

Engine	Engine type code	Gearbox	Engine oil capacity with filter replacement (in litres)	Unbraked trailer (kg)	Recommended nose weight (kg)
<b>1.0 PureTech 68</b>	CE5 / KR5 (EB0 / EB0F)	Manual (5-speed)	3.31	450 - 450 (VASP-LCV)	30 - 30 (VASP) - 46 (LCV)
<b>1.2 PureTech 68</b>	QA5 (EB2FB)	Manual (5-speed)	3.31	-	-
<b>1.2 PureTech 82</b>	CG5 / KQ5 (EB2 / EB2F)	Manual (5-speed)	3.31	520 - 520 (VASP - LCV)	46
	CGP (EB2 MAPS)	ETG5 electronic (5-speed)	3.31	520	46
<b>1.2 PureTech 82 S&amp;S</b>	KQV (EB2F)	ETG5 electronic (5-speed)	3.31	500	33
<b>1.2 PureTech 110 S&amp;S</b>	CQJ / CZJ (EB2DT / EB2DTM)	Manual (5-speed)	3.56	570 / 450	46
	CQQ / CZQ (EB2DT / EB2DTM)	EAT6 automatic (6-speed)	3.56	570 / 450	46
<b>1.6 VTi 120</b>	CA5 (EP6C)	Manual (5-speed)	4.2	580	46
	CAL (EP6C)	Automatic (4-speed)	4.2	580	46
<b>1.6 THP 165 S&amp;S</b>	KHK (EP6FDT)	Manual (6-speed)	4.2	580	46
<b>1.6 THP 208 S&amp;S</b>	KJK (EP6FDTX)	Manual (6-speed)	4.2	580	46

**VASP** : Special purpose vehicle (Véhicule Automoteur SPécialisé - France)

**LCV**: Light Commercial Vehicle

## Diesel engines

Engine	Engine type code	Gearbox	Engine oil capacity with filter replacement (litres)	Unbraked trailer (kg)	Recommended nose weight (kg)
1.6 HDi 75	BX5 (DV6EM)	Manual (5-speed)	3.83	570	46
1.6 BlueHDi 75	KM5 (DV6FE)	Manual (5-speed)	3.83	570 - 570 (VASP-LCV)	46 - 46 (LCV) - 30 (VASP)
1.6 BlueHDi 75 S&S	KMJ (DV6FE)	Manual (5-speed)	3.83	410 - 410 (VASP)	46
1.6 HDi 92	BW5 / BF5 (DV6DM / DV6D)	Manual (5-speed)	3.83	570 - 570 (VASP-LCV)	46
1.6 e-HDi 92 S&S	BFS (DV6D)	ETG6 electronic (6-speed)	3.83	570	46
1.6 BlueHDi 100	KE5 (DV6FD)	Manual (5-speed)	3.83	570 - 570 (VASP-LCV)	46
1.6 BlueHDi 100 S&S	KEJ (DV6FD)	Manual (5-speed)	3.83	520 - 570 (LCV)	46
	KES (DV6FD)	ETG6 electronic (6-speed)	3.83	570	46
1.6 BlueHDi 115 S&S	LAK (DV6FCD)	Manual (6-speed)	3.83	570	46
1.6 BlueHDi 120 S&S	KDK (DV6FC)	Manual (6-speed)	3.83	570	46

VASP : Special purpose vehicle (Véhicule Automoteur SPécialisé - France)

LCV : Light Commercial Vehicle

## Dimensions (in mm)

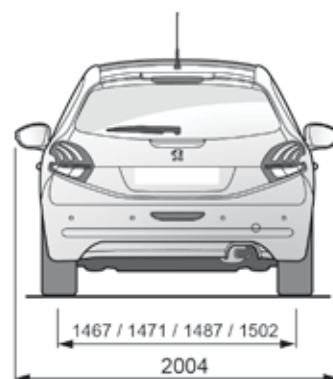
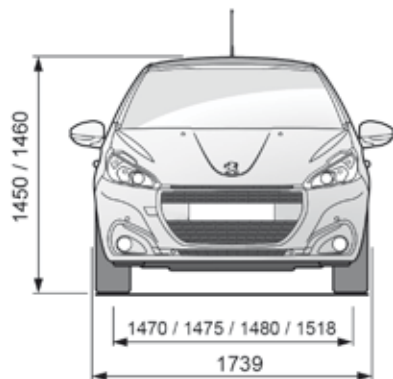

**5-door**

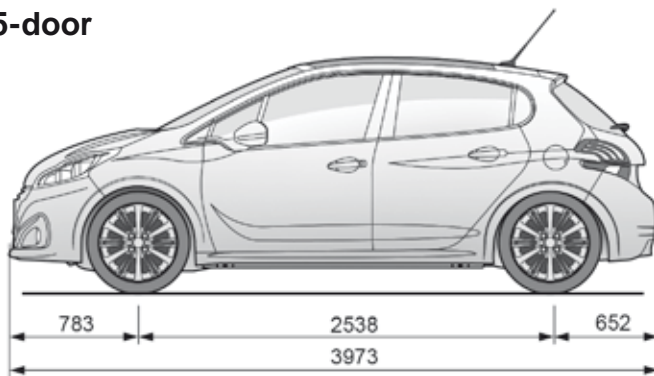

**3-door**

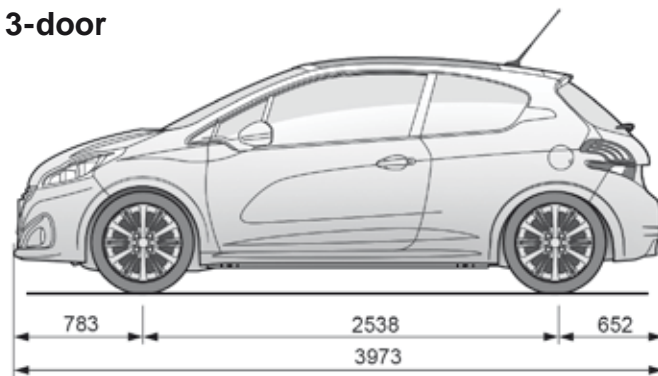



## Affaire version

Number of seats: 2.

Boot volume: 1.062 m<sup>3</sup>

Load floor length: 1.335 m.

Load width between wheel arches: 1.042 m.

Load width at centre: 1.061 m.

Load height at centre: 0.857 m.

## Identification markings

Various visible markings for the identification of your vehicle.

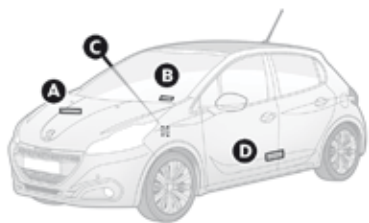
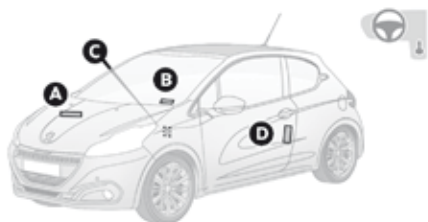

**A. Vehicle Identification Number (VIN) under the bonnet.**

This number is engraved on the bodywork near the damper support.

**B. Vehicle Identification Number (VIN) at the bottom of the windscreen aperture.**

This number is indicated on a self-adhesive label which is visible through the windscreen.

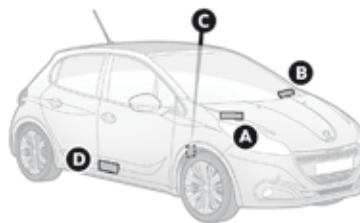
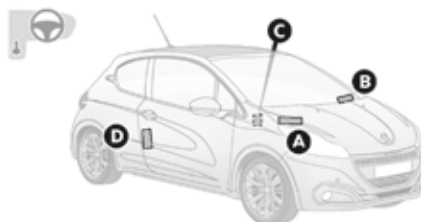

**C. Manufacturer's label.**

The VIN is indicated on a self-destroying label affixed to the middle pillar, on the passenger's side.

**D. Tyre/paint label.**

This label is fitted to the middle pillar, on the driver's side.

It bears the following information:

- the tyre inflation pressures with and without load,
- the tyre sizes,
- the inflation pressure of the spare wheel,
- the paint colour code.

**i** The tyre pressures must be checked when the tyres are cold, at least once a month.

**☘** Low tyre pressures increase fuel consumption.



# 9

# Emergency call

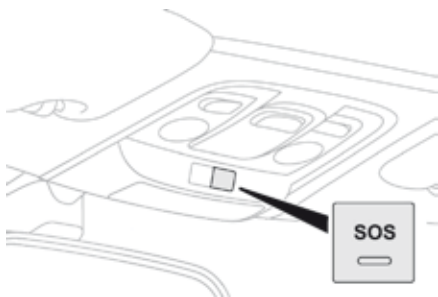

\* Depending on the geographical cover of "PEUGEOT Connect SOS", "PEUGEOT Connect Assistance" and the official national language selected by the owner of the vehicle.

The list of countries covered and PEUGEOT CONNECT services is available from dealers or at [www.peugeot.co.uk](http://www.peugeot.co.uk).

## PEUGEOT Connect SOS

### Test of operation of the system:

#### SOS



The green indicator lamp comes on for 3 seconds when the ignition is switched on, signifying that a call can be made.

#### SOS



Contact a PEUGEOT dealer if the orange indicator lamp comes on:

- flashing, then off: the system has a fault.
- on fixed: the back-up battery must be replaced.

In either case, the emergency and assistance calls service may not work.

Contact a PEUGEOT dealer as soon as possible.



The fault with the system does not prevent the vehicle being driven.

### Operation: "Emergency call".

Pressing this button for more than 2 seconds starts a call to the PEUGEOT Connect SOS centre.

- The green indicator lamp flashes.
- A voice message confirms that the call is being dealt with.

The green indicator lamp on fixed indicates that communication has been established. It goes off at the end of the communication.

The "PEUGEOT Connect SOS" centre immediately locates your vehicle, communicates in your language\*, and depending on the circumstances, makes a call to the appropriate public emergency services\*.

### Conditions for use:

- In countries where the service is not available, or when the locating service has been expressly declined, the call is sent directly to the emergency services (112) without the vehicle location. **112** is the telephone number reserved for emergency calls and is accepted throughout the European Union.
- "PEUGEOT Connect SOS" is subject to the terms and conditions for the service available from dealers, and to technological and technical limitations.

### Inadvertent press:

- pressing brings on the green indicator lamp.
- pressing again immediately cancels the call. A voice message confirms the cancellation.
- if the call connects, explain to the contact that it was a mistake. The green indicator lamp goes off at the end of the call.





# Assistance call

## PEUGEOT Connect Assistance



In the event of a breakdown, pressing for more than 2 seconds starts the call.

A voice message confirms that the call has been made.

### Inadvertent press:

- pressing again immediately cancels the call. A voice message confirms the cancellation.

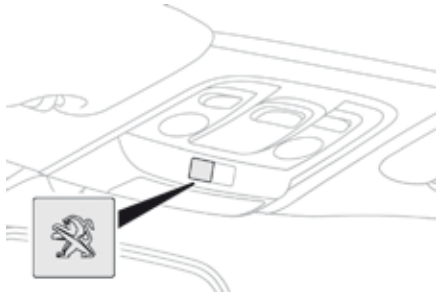

If an impact is detected by the airbag control unit, and independently of the deployment of any airbags, an emergency call is made automatically.



If you purchased your vehicle outside the PEUGEOT dealer network, we invite you to have a dealer check the configuration of these services and, if desired, modified to suit your wishes. In a multi-lingual country, configuration is possible in the official national language of your choice.



For technical reasons and in particular to improve the quality of "PEUGEOT CONNECT services" to customers, the manufacturer reserves the right to update the vehicle's on-board telematic system.



If you benefit from the PEUGEOT Connect Packs offer with the SOS and assistance pack included, there are additional services available to you in your MyPEUGEOT personal space, via the PEUGEOT Internet website in your country, accessible on [www.peugeot.co.uk](http://www.peugeot.co.uk).

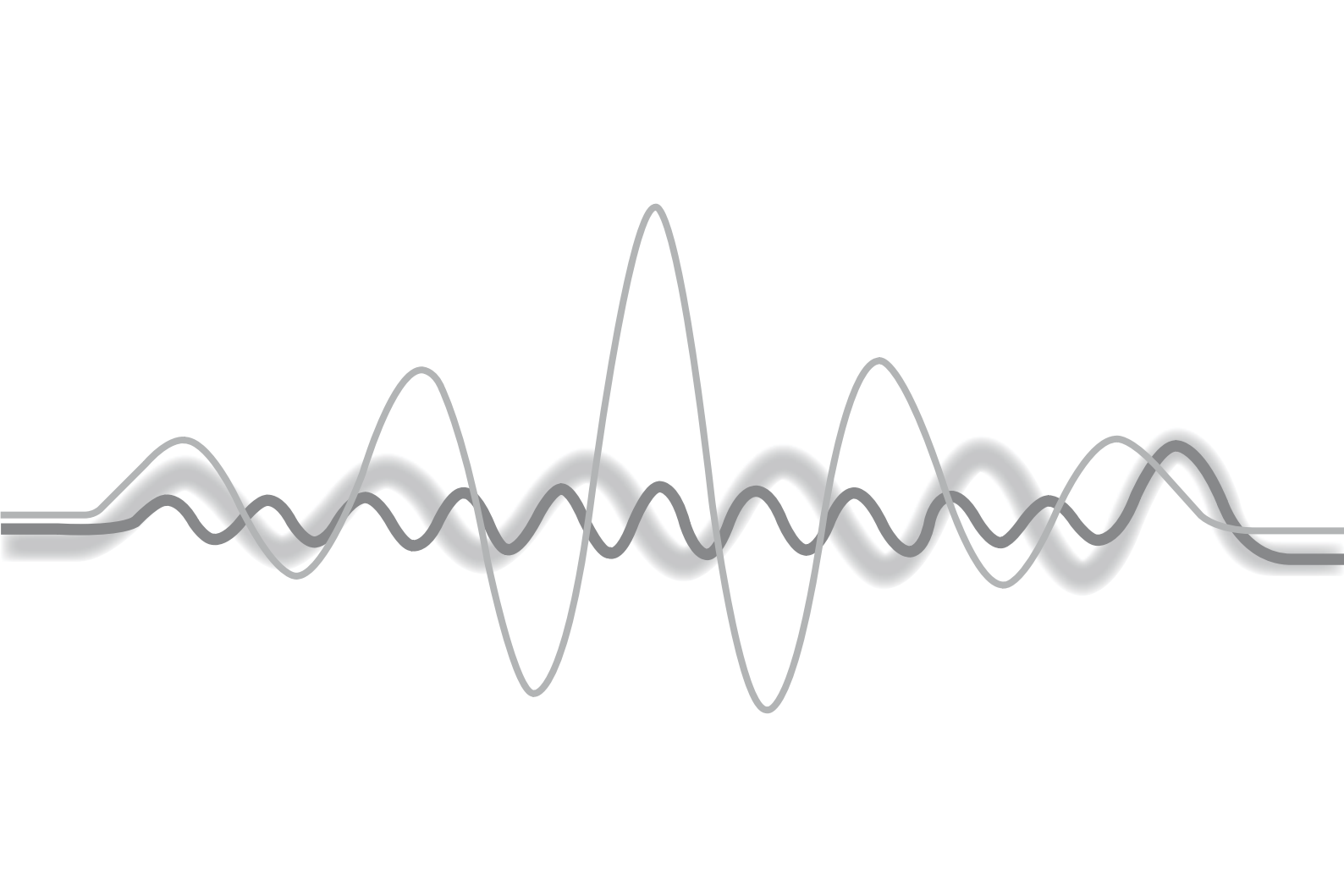

## 7-inch touch screen

### GPS satellite navigation - Multimedia audio - Bluetooth® telephone



	Contents
First steps	226
Steering mounted controls	228
Menus	229
Navigation	230
Navigation - Guidance	238
Traffic	242
Radio Media	244
Radio	250
DAB (Digital Audio Broadcasting) radio	252
Media	254
Settings	258
Connected services	266
Internet browser	267
MirrorLink™	270
CarPlay®	274
Telephone	278
Frequently asked questions	286

**i** The system is protected in such a way that it will only operate in your vehicle.

**!** As a safety measure, the driver should only carry out operations which require prolonged attention while the vehicle is stationary. The display of an energy economy mode message signals that electrical systems operating are going into standby. Refer to the energy economy mode section.

# First steps

Use the buttons to the left of the touch screen for access to the menu carousels, then press the virtual buttons in the touch screen. Each menu is displayed in one or two pages (primary page and secondary page).



**i** In very hot conditions, the system may go into stand-by (screen and sound completely off) for a minimum period of 5 minutes.

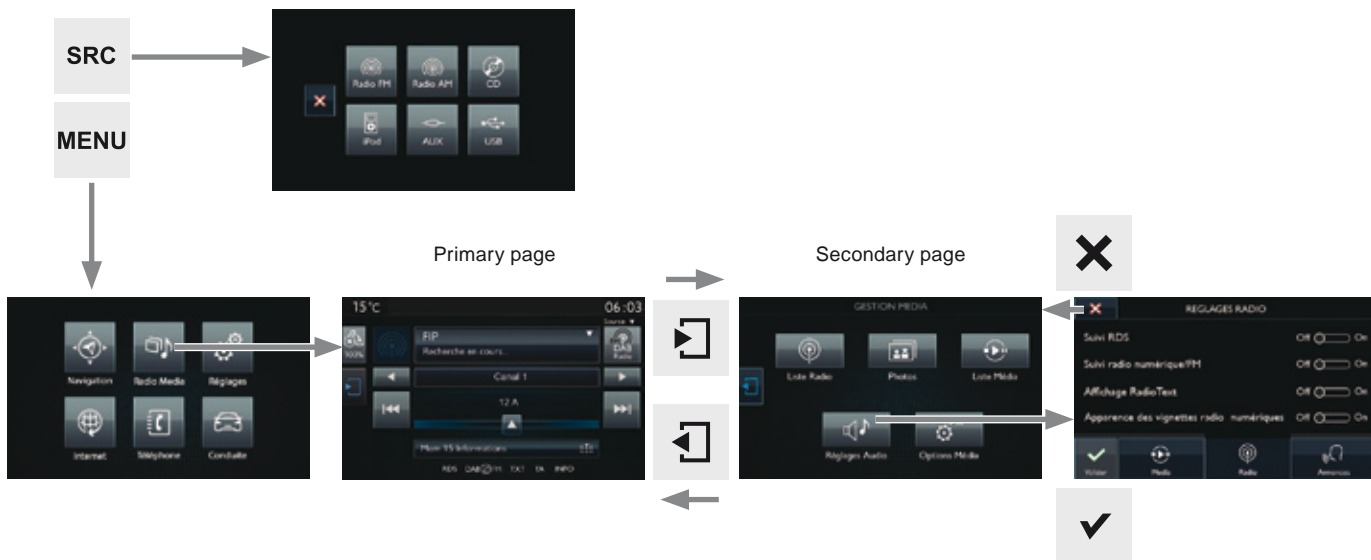

Short-cuts: using the touch buttons in the upper band of the touch screen, it is possible to go directly to the selection of audio source, the list of stations (or titles, depending on the source).

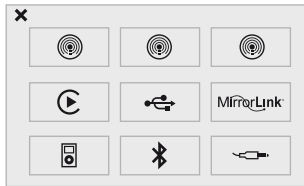

Selection of audio source (depending on version):

- FM /DAB\* /AM stations.
- USB memory stick.
- CD player (located in the glove box)\*.
- Smartphone via MirrorLink™ or CarPlay®.
- Telephone connected by Bluetooth\* and with Bluetooth\* audio streaming.
- Media player connected to the auxiliary socket (jack, cable not supplied).
- Jukebox\*, after first copying audio files to the internal memory of the system.

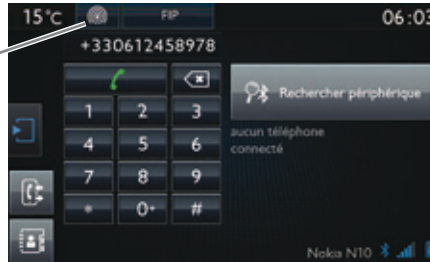

### MENU

Press on **Menu** to display the menu carousel.

### SRC

Press on **SRC** to display the audio sources carousel.

Volume adjustment (each source is independent, including traffic announcements (TA) and navigation instructions).



With the engine running, press to mute the sound.

With the ignition off, press to switch the system on.

**i** In very hot conditions, the volume may be limited to protect the system. The return to normal takes place when the temperature in the passenger compartment drops.

**i** The screen is of the "resistive" type, it is necessary to press firmly, particularly for "flick" gestures (scrolling through a list, moving the map...). A simple wipe will not be enough. Pressing with more than one finger is not recognised. The screen can be used when wearing gloves. This technology allows use at all temperatures.

**!** To clean the screen, use a soft non-abrasive cloth (spectacles cloth) without any additional product. Do not use pointed objects on the screen. Do not touch the screen with wet hands.

\* Depending on equipment.

# Steering mounted controls

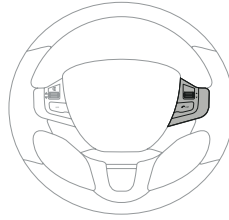
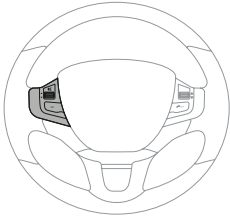

Press: mute on / off.



Increase volume.



Decrease volume.



Change audio source: radio, media.



Radio, rotate: automatic search for the previous / next station.

Radio, press: preset stations.

Media, rotate: previous / next track.

Press: confirm a selection.



Telephone: start or answer a call.

Call in progress: telephone menu (end call, secret mode, hands-free mode).

Telephone, press and hold: reject an incoming call, end a call in progress; other than call in progress, telephone menu.

Radio: display the list of stations.

Media: display the list of tracks.

Radio, press and hold: update the list of stations received.

# Menus



## Navigation

(Depending on equipment)



Enter navigation settings and choose a destination.



## Radio Media

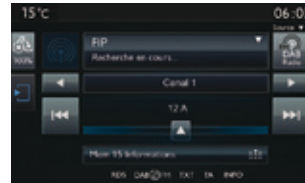

Select an audio source, a radio station, display photographs.



## Settings

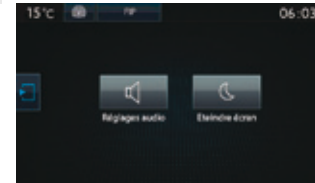

Adjust the settings for sound (balance, ambience, ...) and the display (language, units, date, time, ...).



## Connected services

(Depending on equipment)

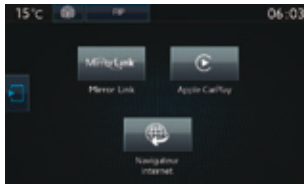

Connect using the "Internet browser". Operate certain applications on your smartphone via MirrorLink™ or CarPlay®.



## Telephone

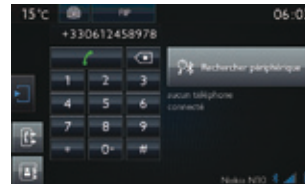

Connect a telephone by Bluetooth®. Access to the CarPlay® function after connection of your smartphone by USB cable.



## Driving







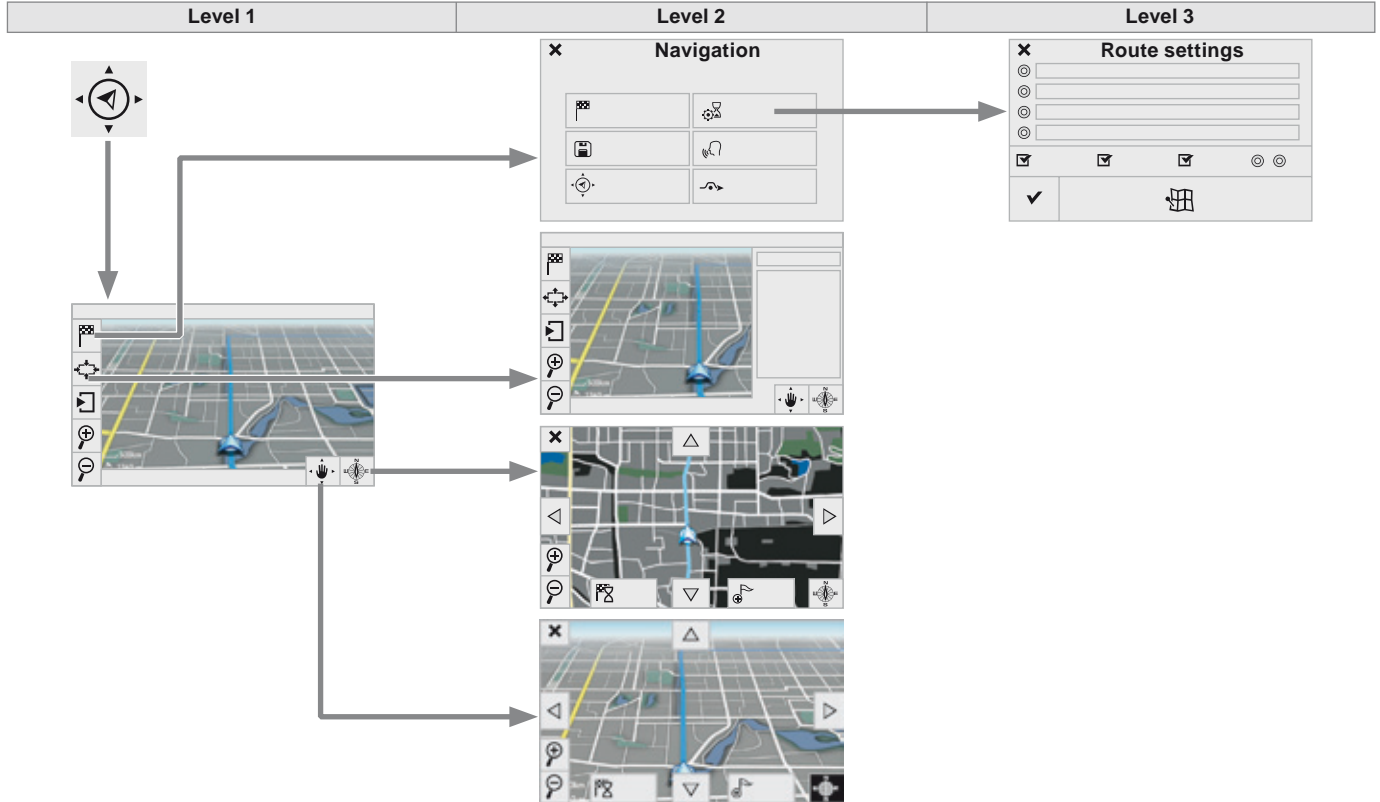



















Access to the trip computer. Activate, deactivate or enter settings for certain vehicle functions.

# Navigation







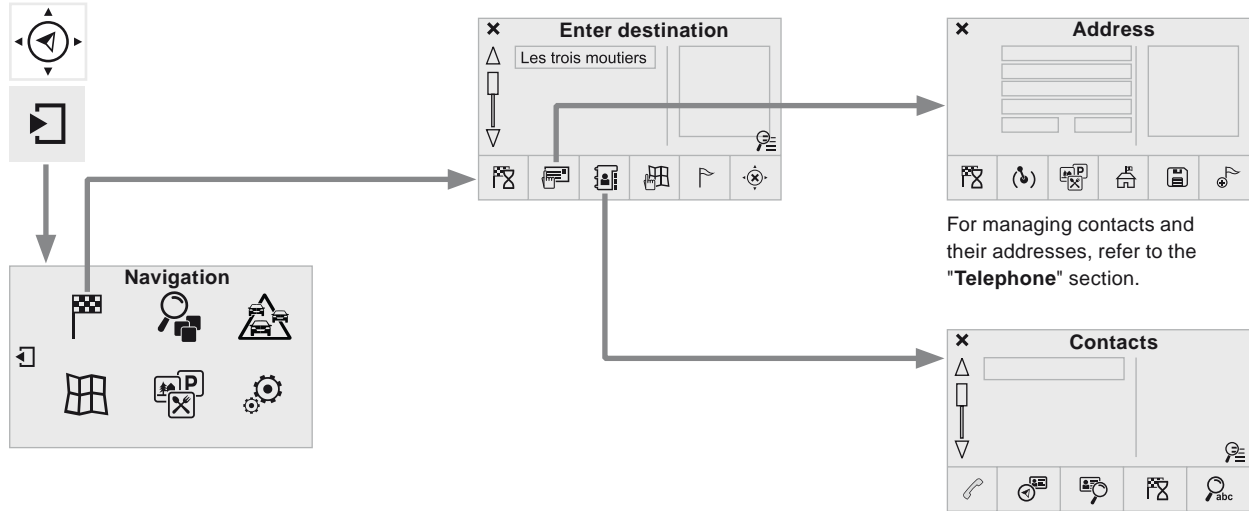

















Level 1		Level 2		Level 3		Comments
  <p><b>Navigation</b> ↓ <b>Settings</b> <b>Navigation</b></p>	 <p><b>Enter destination</b></p>	 <p><b>Route settings</b></p>	 Fastest	<p>Choose the navigation criteria. The map displays the route chosen according to these criteria.</p>	Display recent destinations	
			 Shortest			
			 Time/distance			
			 Ecological			
			 Tolls			
			 Ferries			
			 Traffic			
			 Strict-Close			
			 Show route on map		Display the map and start navigation.	
			 Confirm	Save the options.		
 <p><b>Navigation</b></p>	 <b>Save current location</b>			Save the current address.		
	 <b>Stop navigation</b>			Delete the navigation information.		
	 <b>Voice synthesis</b>			Choose the volume for voice and announcement of street names.		
	 <b>Diversion</b>			Detour from your initial route by a determined distance.		
				Display in text mode		
				Zoom in.		
				Zoom out.		
				Display in full screen mode. Use the arrows to move the map.		
				Switch to 2D map.		



For managing contacts and their addresses, refer to the "Telephone" section.

To use the telephone functions, refer to the "Telephone" section.







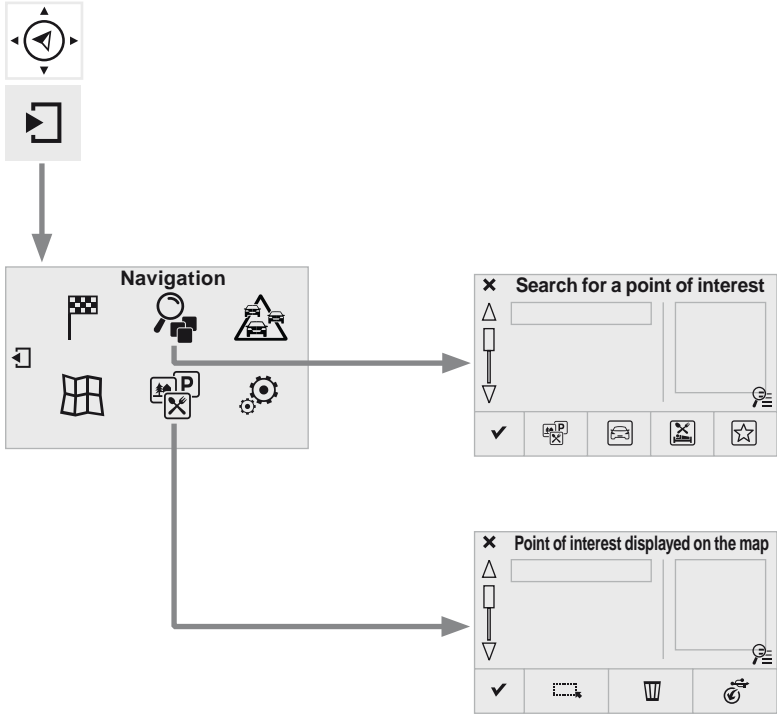





Level 1		Level 2		Level 3		Comments						
  	<p style="text-align: center;"> <b>Navigation</b>  ↓  <b>Secondary page</b>  ↓  <b>Enter destination</b> </p>	 <b>Address</b>	 Current loc.	Address settings	 Point of interest	 Town center	 Save	Save the current address.	 Add waypoint	Add a waypoint to the route.	 Navigate to	Press to calculate the route.
			 <b>Contacts</b>		 Addresses	Select a contact then calculate the route.	 View	 Navigate to	 Search for contact	 Call		
					 <b>On the map</b>				Display the map and zoom to view the roads.			
					 <b>Itinerary</b>				Create, add or delete a waypoint or view the itinerary.			
					 <b>Stop</b>				Delete navigation information.			
			 <b>Navigate to</b>				Press to calculate the route.					



Level 1	Level 2	Level 3
---------	---------	---------







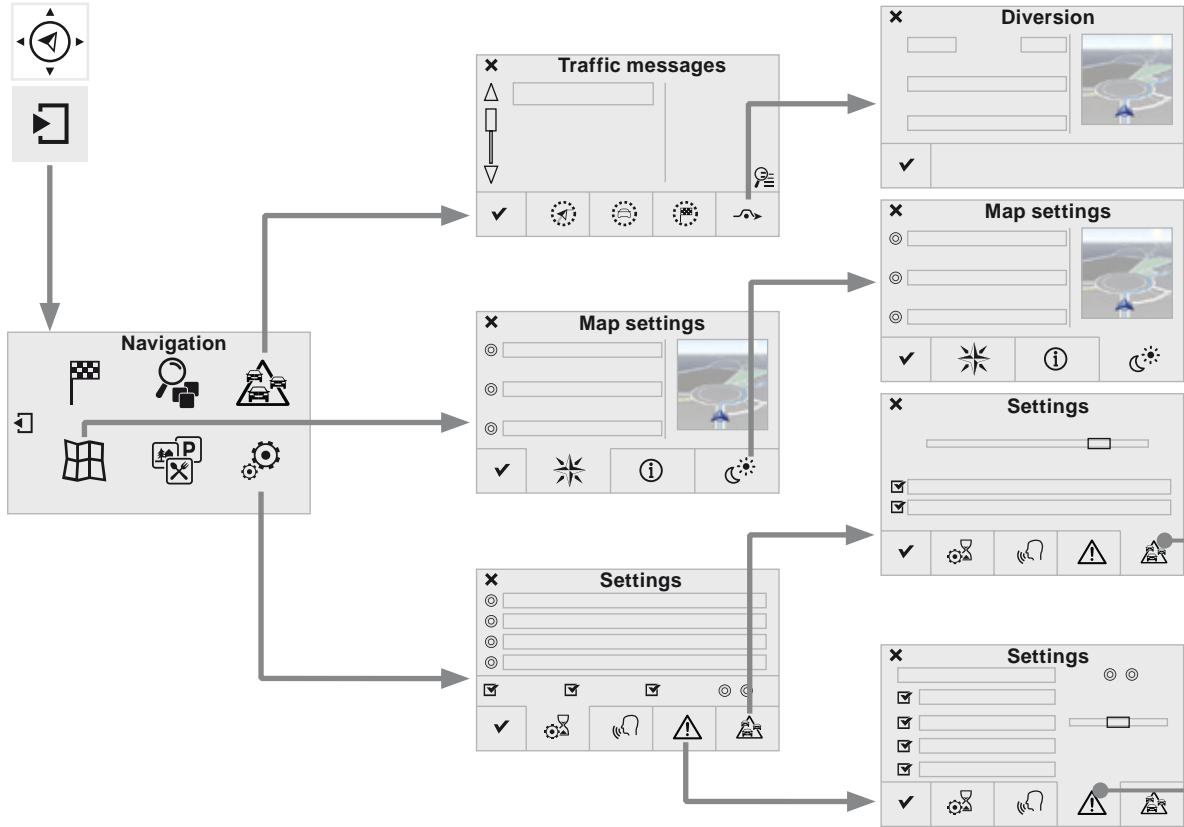

















Level 1		Level 2		Level 3	Comments
  	Navigation	 All POIs			List of categories available. After choosing the category, select the points of interest.
	↓	 Motor			
	Secondary page	 Dining/hotels			
	↓	 Personal			
	Search for POI	<input checked="" type="checkbox"/> Search			Save the settings.
  	Navigation	 Select all			Choose the display settings for POIs.
	↓	 Delete			
	Secondary page	 Import POIs			
	↓	<input checked="" type="checkbox"/> Confirm			Save the options.
Show POIs					



Moving between the two menus.

Level 1		Level 2		Level 3		Comments	
  	Navigation ↓ Secondary page ↓ Traffic messages	 <b>On the route</b>				Settings for the choice of messages and the filter radius.	
		 <b>Around vehicle</b>					
		 <b>Near destination</b>					
		 <b>Detour</b>	<input type="radio"/>	Detour over a distance	<input type="radio"/>		Recalculate route
		<input checked="" type="checkbox"/> <b>Finish</b>					
  	Navigation ↓ Secondary page ↓ Map settings	 <b>Orientation</b>		<input type="radio"/>	Flat view north heading	Choose the display and orientation of the map.	
				<input type="radio"/>	Flat view vehicle heading		
				<input type="radio"/>	Perspective view		
		 <b>Maps</b>					
		 <b>Aspect</b>	<input type="radio"/>	"Day" map colour	<input type="radio"/>		"Night" map colour
				<input type="radio"/>	Auomatic day/night		
		<input checked="" type="checkbox"/> <b>Confirm</b>					
  	Navigation ↓ Secondary page ↓ Settings	 <b>Route settings</b>				Enter settings and choose the volume for the voice and announcement of street names.	
		 <b>Voice</b>					
		 <b>Alarm!</b>					
		 <b>Traffic options</b>					
		<input checked="" type="checkbox"/> <b>Confirm</b>					Save your selections.

# Navigation - Guidance

## Choosing a new destination

### Towards a new destination



Press on **Navigation** to display the primary page.



Press on the secondary page.



Select "**Enter destination**".



Select "**Address**".

▼	FRANCE	⊞
▼	PARIS	⊞
▼	Blvd Hossein	⊞
N°/R	20	⊞

Select the "**Country**:" from the list offered, then in the same way the "**City**:" or its post code, the "**Road**:", the "**N**°:". Confirm each time.



Select "**Save**" to save the address entered as a contact entry. The system allows up to 200 entries.



Select "**Navigate to**".



Choose the navigation criteria: "**Fastest**" or "**Shortest**" or "**Time/distance**" or "**Ecological**".



Choose the restriction criteria: "**Tolls**", "**Ferries**", "**Traffic**", "**Strict**", "**Close**".



Select "**Confirm**".

Or



Press on "**Show route on map**" to start navigation.



To delete navigation information, press on "**Settings**".



Press on "**Stop navigation**".



To resume navigation press on "**Settings**".



Press on "**Resume guidance**".



## Towards a recent destination



Press on **Navigation** to display the primary page.



Press on the secondary page.



Select "**Enter destination**".

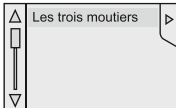

Select an address from the list offered.



Select "**Navigate to**".



Select the criteria then "**Confirm**" or press "**Show route on map**" to start navigation.

## Towards a contact



To be able to use navigation "towards a contact in the directory", it is first necessary to enter the address for your contact.



Press on **Navigation** to display the primary page.



Press on the secondary page.



Select "**Enter destination**".



Select "**Contacts**".

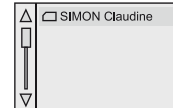

Select a destination from the contacts in the list offered.



Select "**Navigate to**".



Select the criteria then "**Confirm**" to start navigation.

## Towards GPS coordinates



Press on **Navigation** to display the primary page.



Press on the secondary page.



Select "**Enter destination**".



Select "**Address**".



Enter the "**Longitude**:" then the "**Latitude**:".



Select "**Navigate to**".



Select the criteria then "**Confirm**" or press "**Show route on map**" to start navigation.

## Towards a point on the map



Press on **Navigation** to display the primary page.



Press on the secondary page.



Select "**Enter destination**".



Select "**On the map**".

Zooming in on the map shows points with information.

A long press on a point opens its content.

## Towards points of interest (POI)

Points of Interest (POI) are listed in different categories.



Press on **Navigation** to display the primary page.



Press on the secondary page.



Select "**Search for POI**".



Select "**All POIs**".

Or



"**Motor**",

Or



"**Dining/hotels**".



**i** An annual mapping update allows new points of interest to be presented to you. You can also update the Risk areas / Danger areas every month. The detailed procedure is available on: <http://peugeot.navigation.com>.

## Risk areas / Danger zone alert settings



Press on **Navigation** to display the primary page.



Press on the secondary page.



Select "**Settings**".



Select "**Alarm!**" (Alert).

It is then possible to activate Risk areas alerts then:

- "Audible warning"
- "Alert only when navigating"
- "Alert only for overspeed"
- "Display speed limits"
- Timing: the choice of timing allows the time before giving a Risk areas alert to be defined.



Select "**Confirm**".

**!** This series of alerts and displays is only available if Risk areas have first been downloaded and installed on the system.

## Traffic

### Traffic information

#### Display of messages



Press on **Navigation** to display the primary page.



Press on the secondary page.



Select "**Traffic messages**".

Choose filter settings for:



"**On the route**",



"**Around**",



"**Near destination**", filters to fine-tune the list of messages.

Press again to remove the filter.



Select the message from the list offered.



Select the magnifying glass to have voice information.

**i** TMC (Traffic Message Channel) messages on GPS-Navigation contain traffic information transmitted in real time.

## Setting filters



Press on **Navigation** to display the primary page.



Press on the secondary page.



Select "**Settings**".



Select "**Traffic options**".



Select:  
- "**Be advised of new messages**",  
- "**Speak messages**".

Then enter the filter radius.



Select "**Confirm**".

**i** We recommend a filter radius of:

- 12 miles (20 km) in urban areas,
- 30 miles (50 km) on motorways.

## Receiving TA messages



Press on **Navigation** to display the primary page.



Press on the secondary page.



Select "**Settings**".



Select "**Voice**".

Off  On









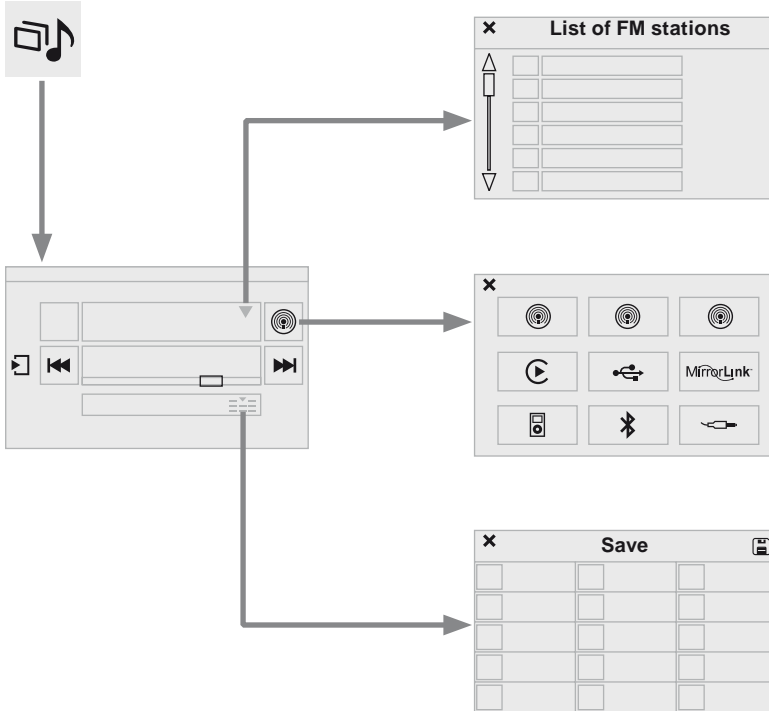









Activate / Deactivate "**Traffic (TA)**".

**i** The TA (Traffic Announcement) function gives priority to TA alert messages. To operate, this function needs good reception of a radio station transmitting this type of message. When a traffic report is transmitted, the current audio source is interrupted automatically to play the TA message. Normal playback of the audio source resumes at the end of the transmission of the message.









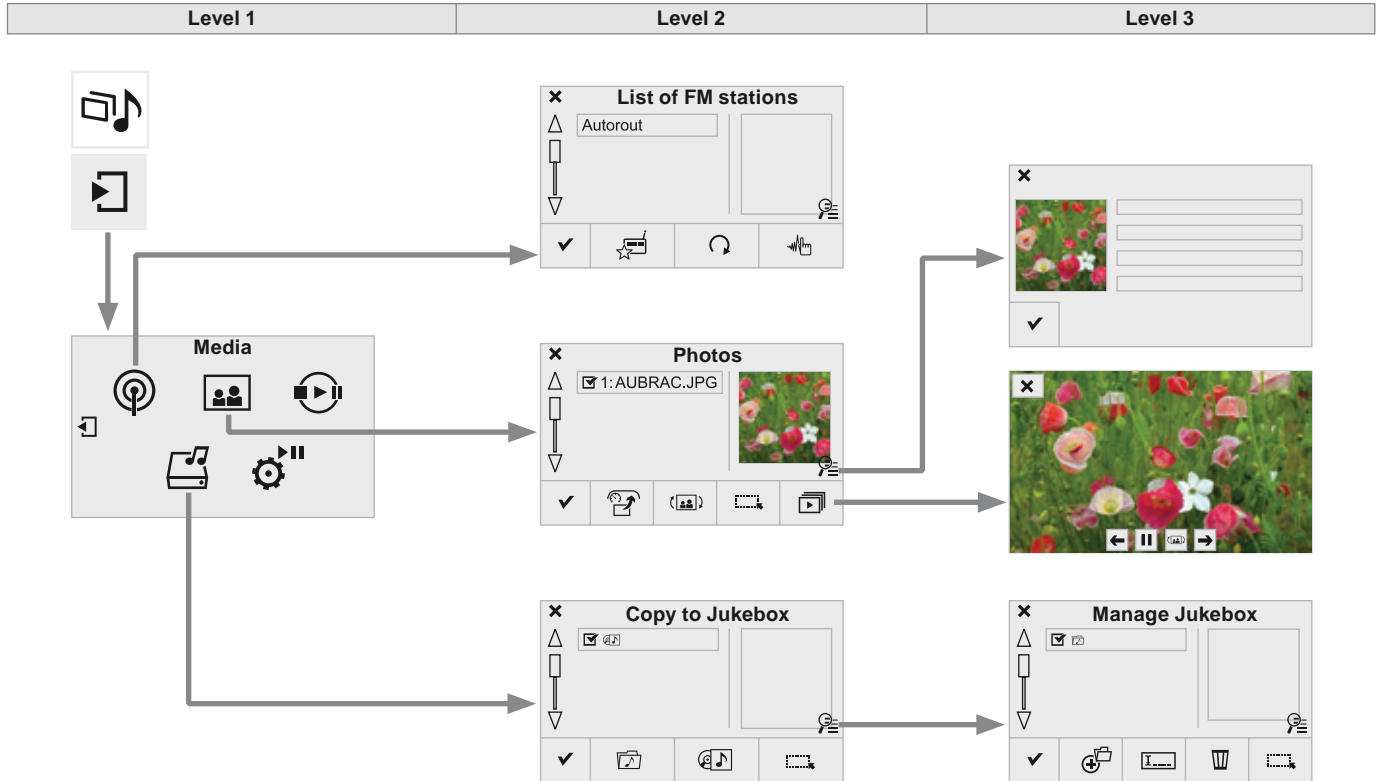















# Radio Media











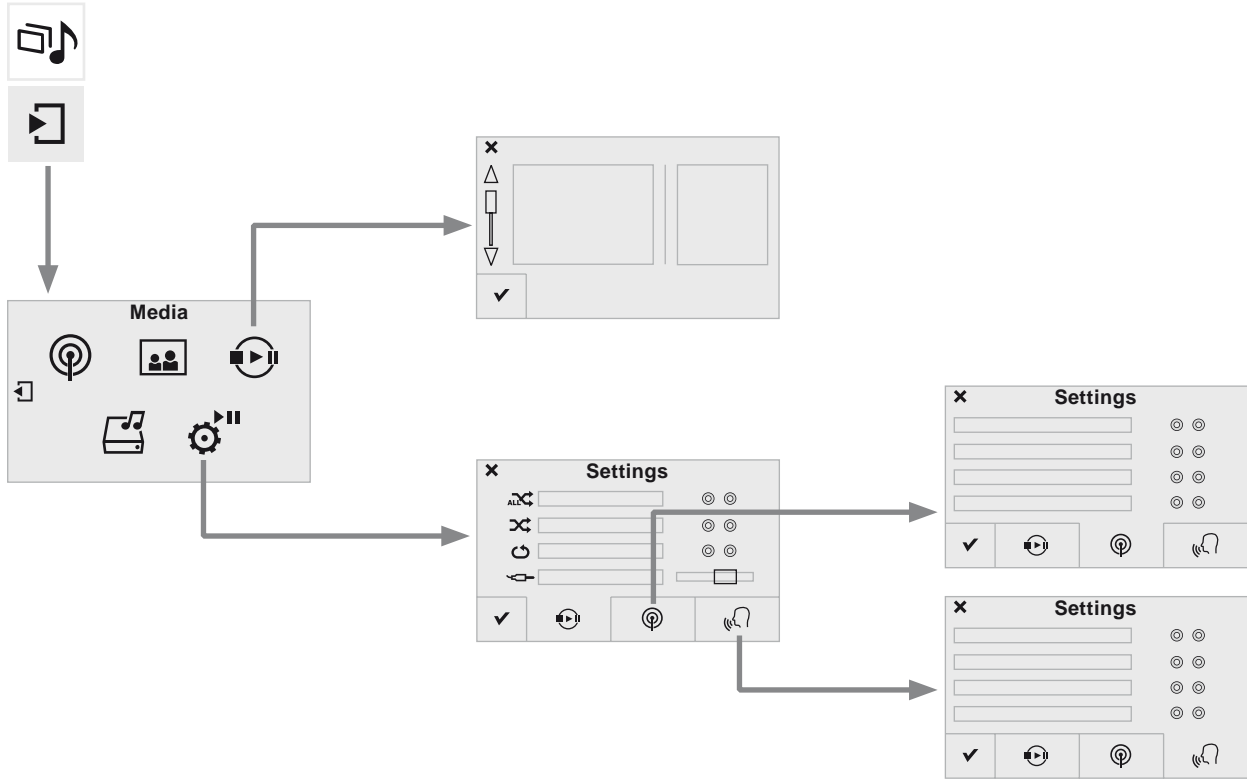



Level 1		Level 2		Comments
 	Radio Media ↓ List		List of FM stations	Press on a radio station to select it.
 	Radio Media ↓ Source	 <b>FM Radio</b>  <b>DAB Radio</b>  <b>AM Radio</b>  <b>USB</b>  <b>CD</b>  <b>MirrorLink™</b>  <b>CarPlay®</b>  <b>iPod</b>  <b>Bluetooth</b>  <b>AUX</b>  <b>Jukebox</b>		Select change of source.
 	Radio Media ↓ Save			Press an empty location to Save it.





Level 1		Level 2		Level 3		Comments
  	Radio Media	   	Save			Press a radio station to select it.
	Secondary page		Update list			Update the list of stations received.
	Radio list		Frequency			Enter the desired radio frequency.
			Confirm			Save the settings.
  	Radio Media	    	Home screen			Display the selected photo in the home page.
	Secondary page		Rotate			Rotate the photo 90°.
	Photos		Select all			Select all the photos in the list. Press again to deselect.
			Slideshow	←	Previous photo.	Display the photos in sequence, full screen. The system supports the following image formats: .gif, .jpg, .bmp, .png.
				▶	Pause / Play.	
				→	Next photo.	
			Full screen			Display the selected photo full-screen.
  	Radio Media	    	Sort by folder			Choose a selection mode.
	Secondary page		Sort by album			
	Manage Jukebox		Select all			
			Copy			Copy files to the Jukebox.
			Magnifying glass	⊕	Create folder	Choose the desired function.
				⋮	Rename	
				🗑	Delete	
	⋮	Select all				
		✓	Confirm			Save the settings.



Level 1		Level 2		Level 3		Comments	
	Radio Media					Presentation of the last media used.	
	Secondary page						
	Media list						
	Radio Media ↓ Secondary page ↓ Settings		Media ↓ Settings	 Shuffle (all tracks)	Choose the play settings.		
				 Shuffle (current album)			
				 Repeat			
				 Aux. amplification			
			Radio ↓ Settings	<input type="checkbox"/> RDS options	Activate or deactivate the settings.		
				<input type="checkbox"/> DAB/FM station tracking			
				<input type="checkbox"/> Display Radio Text			
				<input type="checkbox"/> Digital radio slideshow display			
			Announcements ↓ Settings	<input type="checkbox"/> Traffic announcements (TA)	Activate or deactivate the settings.		
				<input type="checkbox"/> News - Weather			
				<input type="checkbox"/> Sport - Programm info			
				<input type="checkbox"/> Flash - Unforeseen events			
			Confirm				Save the settings.

# Radio

## Selecting a station



Press on **Radio Media** to display the primary page.



Select "**List**" in the primary page.

Or



Press on **Radio Media** to display the primary page.



Press on the secondary page.



Select "**Radio list**" in the secondary page.

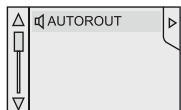

Select a radio station from the list offered.



Select "**Update list**" to refresh the list.

To select a preset radio station.



Press on **Radio Media** to display the primary page.



Select "**Save**".



Select a preset radio station in the list.



If necessary, select change of source.



Select "**FM Radio**".

Or



"**AM Radio**".

**!** Radio reception may be affected by the use of electrical equipment not approved by PEUGEOT, such as a USB charger connected to the 12 V socket. The exterior environment (hills, buildings, tunnel, car park, below ground...) may prevent reception, even in RDS station tracking mode. This phenomenon is normal in the propagation of radio waves and is in no way indicative of a fault with the audio system.

## Changing a radio frequency



Press on **Radio Media** to display the primary page.



**By automatic frequency search**

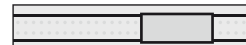

Press **◀** or **▶** to move the cursor for an automatic search down or up for a radio frequency.

**THEN**



Select change source.



Select "**FM Radio**".

Or



"**AM Radio**".

OR



Press on **Radio Media** to display the primary page.



Press on the secondary page.



Press on **Frequency**.

THEN



Enter the frequency in full (e.g.: 92.10 MHz) using the keypad then **"Confirm"**.

FRANCE BLEU

### Changing radio station

Pressing the name of the current radio station brings up a list.

To change radio station press the name of the desired station.

## Presetting a station

Select a radio station or frequency (refer to the corresponding section).



Press on **"Save"** (preset).

Mémoire 1

Select a number in the list to preset the previously chosen radio station.

A long press on a number saves (presets) the station.

Or



A press on this button presets all of the stations one after the other.

## Recalling preset stations



Press on **Radio Media** to display the primary page.



Select **"Save"** (preset).

## Activating / Deactivating RDS



Press on **Radio Media** to display the primary page.



Press on the secondary page.



Select **"Settings"**.



Select **"Radio"**.

Off



On

Activate/deactivate **"RDS options"**.



RDS, if activated, allows you to continue listening to the same station by automatic retuning to alternative frequencies. However, in certain conditions, coverage of an RDS station may not be assured throughout the entire country as radio stations do not cover 100 % of the territory. This explains the loss of reception of the station during a journey.

# DAB (Digital Audio Broadcasting) radio

15°C 06:03

Source ▾

FIP  
Recherche en cours...

100%

Canal 1

12 A

Mem 15 Informations

RDS DAB FM TXT TA INFO

Any thumbnail broadcast by the station.

Manage the Jukebox. Display current action.

Secondary page.

Previous "Multiplex". Previous radio station.

Display the name and number of the multiplex service being used.

Short-cut: access to the choice of audio source and the list of stations (or titles, depending on the source).

Select the radio station.

Select the audio source. Display the "DAB" band.

Display of "Radiotext" for the current station.

Next "Multiplex". Next radio station.

Preset stations, buttons 1 to 15. Short press: select the preset radio station. Long press: preset a radio station.

Display of options:  
if active but not available, the display will be greyed out,  
if active and available, the display will be blank.

**i** If the "DAB" radio station being listened to is not available on "FM", the "DAB FM" option is greyed out.



**!** Journaline® is a text-based information service designed for digital radio systems. It provides text-based information structured around topics and sub-topics. This service is available from the "LIST OF DAB STATIONS" page.

## Digital radio

- ! Digital radio provides higher quality reception and also the graphical display of current information on the radio station being listened to. Select "List" in the primary page.  
The range of multiplexes available is displayed in alphabetical order.



Press on **Radio Media** to display the primary page.



Select change of source.



Select "**DAB Radio**".



Select "**List**" in the primary page.

or



Select "**Radio list**" in the secondary page.

Select the radio station from the list offered.

## DAB / FM auto tracking

- i "DAB" does not cover 100% of the territory.  
When the digital radio signal is poor, "DAB/FM station tracking" allows you to continue listening to the same station, by automatically switching to the corresponding "FM" analogue station (if there is one).



Press on **Radio Media** to display the primary page.



Press on the secondary page.



Select "**Settings**".



Select "**Radio**".

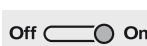

Select "**Digital/FM auto tracking**" then "**Confirm**".

- i If "DAB/FM station tracking" is activated, there is a difference of a few seconds when the system switches to "FM" analogue radio with sometimes a variation in volume.  
When the digital signal is restored, the system automatically changes back to "DAB".

- ! If the "DAB" station being listened to is not available on "FM" ("**DAB/FM**" option greyed out), or "DAB/FM station tracking" is not activated, the sound will cut out while the digital signal is too weak.

# Media

## USB player

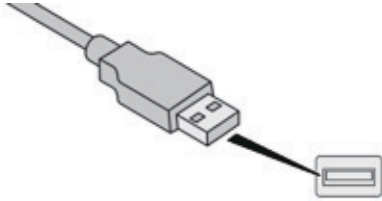

Insert the USB memory stick into the USB port or connect the USB device to the USB port using a suitable cable (not supplied).

The system builds playlists (in temporary memory), an operation which can take from a few seconds to several minutes at the first connection.

Reduce the number of non-music files and the number of folders to reduce the waiting time.

The playlists are updated every time the ignition is switched off or connection of a USB memory stick. The lists are memorised: if they are not modified, the subsequent loading time will be shorter.

## Auxiliary (AUX) socket

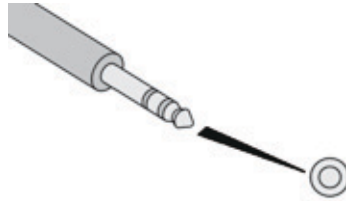

Connect the portable device (MP3 player...) to the auxiliary Jack socket using an audio cable (not supplied).

First adjust the volume of your portable device (to a high level). Then adjust the volume of your audio system.

Display and management of the controls are via the portable device.

## CD player

Insert the CD in the player.

## Selecting the source



Press on **Radio Media** to display the primary page.



Select change of source.



Choose the source.

### SRC

The steering mounted **SRC** (source) button can be used to go to the next media source, available if the source is active.



Press on **OK** to confirm the selection.



## Information and advice

The audio equipment will only play audio files with ".wma, .aac, .flac, .ogg and. mp3" file extensions and with a bit rate of between 32 Kbps and 320 Kbps.

It also supports VBR (Variable Bit Rate) mode.

No other type of file (.mp4, ...) can be played.

".wma" files must be of the standard wma 9 type.

The sampling rates supported are 32, 44 and 48 KHz.

It is advisable to restrict file names to 20 characters, without using of special characters (e.g.: " " ? ; ù) to avoid any playing and displaying problems.

In order to be able to play a recorded CDR or CDRW, when recording it is preferable to select the ISO 9660 level 1, 2 or Joliet standard.

If the disc is recorded in another format it may not be played correctly.

It is recommended that the same recording standard is always used for an individual disc, with as low a speed as possible (4x maximum) for optimum sound quality.

In the particular case of a multi-session CD, the Joliet standard is recommended.

Use only USB memory sticks formatted FAT 32 (file allocation table).



The system does not support the simultaneous connection of two identical devices (two memory sticks, two Apple® players) but it is possible to connect one memory stick and one Apple® player at the same time.



It is recommended that the USB cable for the portable device is used.



The system supports USB mass storage devices, BlackBerry® devices or Apple® players via USB ports. The adaptor cable is not supplied. Control of the peripheral device is with the audio system controls. Other peripherals, not recognised on connection, must be connected to the auxiliary socket using a Jack cable (not supplied).

## Bluetooth® audio streaming

Streaming allows audio files on your telephone to be played through the vehicle's speakers.

Connect the telephone: see the "**Telephone**" section, then "**Bluetooth**".  
Choose the "**Audio**" or "**All**" profile.

If play does not start automatically, it may be necessary to start the audio playback from the telephone.

Control is from the peripheral device or by using the audio system buttons.

- ! Once connected in streaming mode, the telephone is considered to be a media source.  
It is recommended that you activate "**Repeat**" on the Bluetooth peripheral.

## Connecting Apple® players

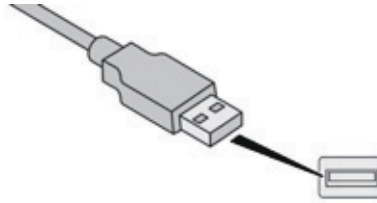

Connect the Apple® player to the USB port using a suitable cable (not supplied).  
Play starts automatically.

Control is via the audio system.

- i The classifications available are those of the portable device connected (artists / albums / genres / playlists / audiobooks / podcasts).  
The default classification used is by artist. To modify the classification used, return to the first level of the menu then select the desired classification (playlists for example) and confirm to go down through the menu to the desired track.

The version of software in the audio system may not be compatible with the generation of your Apple® player.

## Managing the Jukebox

Connect the device (MP3 player...) to the USB port or auxiliary Jack socket using a suitable audio cable.

**i** When no audio file is copied to the system, which has a capacity of 8 GB, all of the Jukebox function symbols are greyed and are not available.



Select "**Media list**".



Select copy "**Copy Jukebox**".



Select "**Sort by folder**".

Or



"**Sort by album**".



Select the magnifying glass to enter the folder or album and select audio file by audio file.



Select "**Confirm**" then "**Copy**".



Select "**New folder**" to create a folder structure in the Jukebox.

Or



Select "**Keep structure**" to retain the structure from the device.









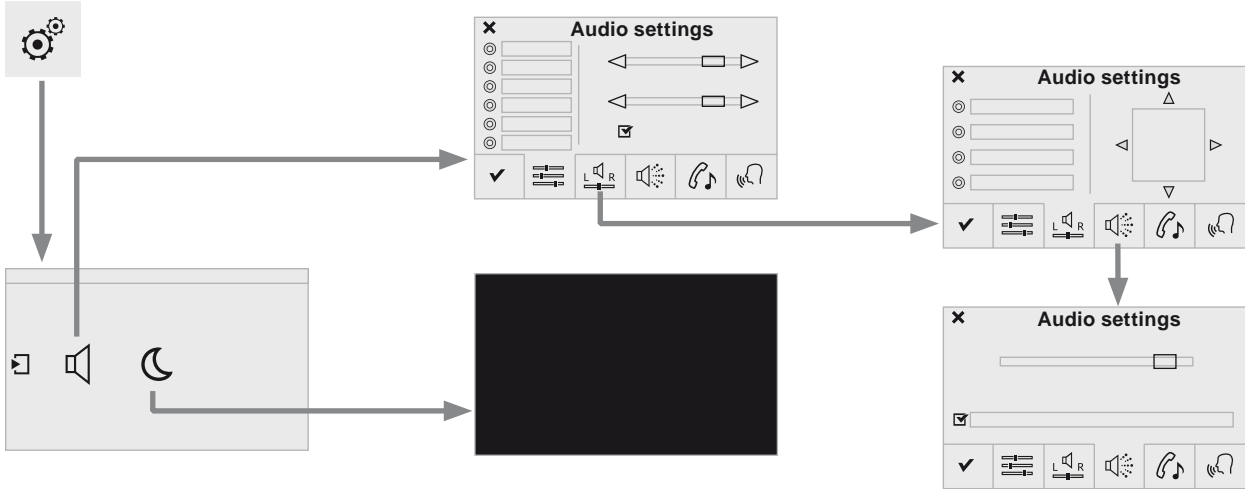



While copying the system returns to the primary page; you can go back to the copy view at any time by selecting this button.









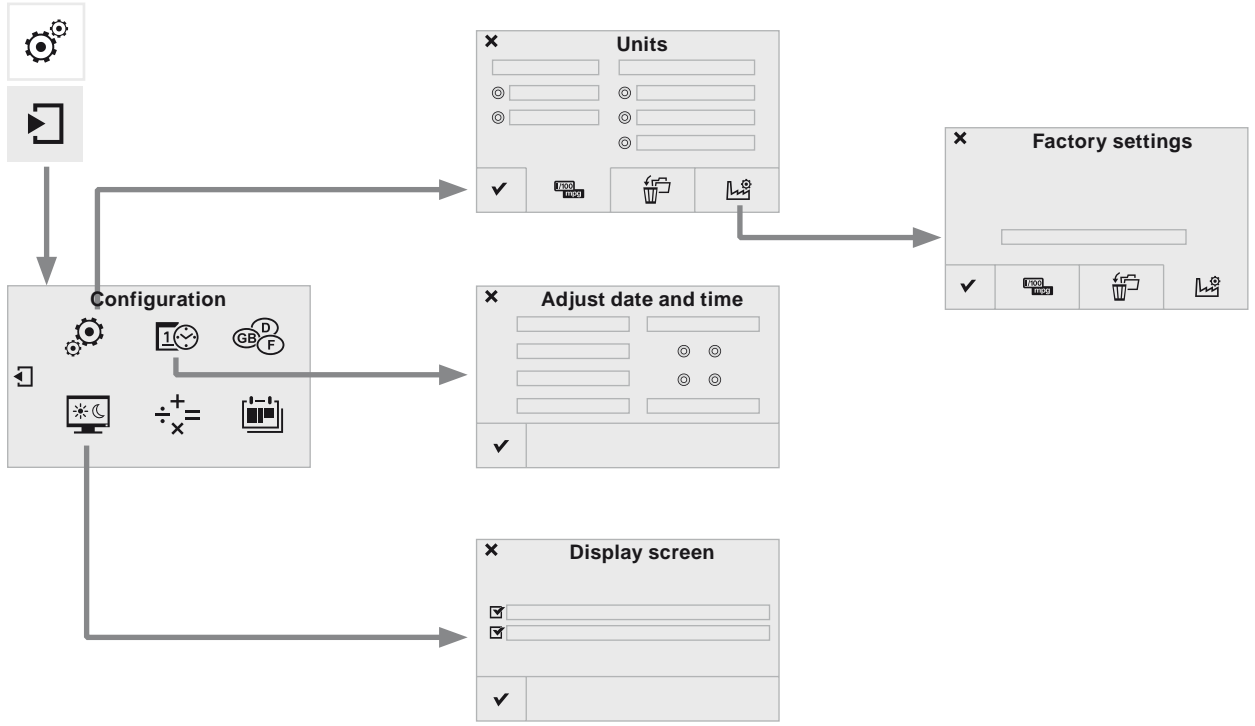







# Settings



Level 1		Level 2		Level 3	Comments
 	<b>Settings</b> ↓ <b>Audio settings</b>		<b>Ambience</b>		Choose the sound ambience.
			<b>Balance</b>		Sound distribution using the Arkamys® system.
			<b>Sound effects</b>		Set the volume or activate the link to vehicle speed.
			<b>Ringtones</b>		Set the telephone ringtone and volume.
			<b>Voice</b>		Set the volume and voice for speaking street names
			<b>Confirm</b>		Save your settings.
 	<b>Settings</b> ↓ <b>Turn off screen</b>				Function that turns off the display. Pressing the screen reactivates it.



Level 1		Level 2		Comments
  	<b>Settings</b> ↓ <b>Secondary page</b> ↓ <b>System Settings</b>	 <b>Units</b>	Set the units used to display distance, fuel consumption and temperature.	
		 <b>Delete data</b>	Select the desired data in the list then press Delete.	
		 <b>Factory settings</b>	Return to factory settings.	
		 <b>Confirm</b>	Save the settings.	
  	<b>Settings</b> ↓ <b>Secondary page</b> ↓ <b>Time/Date</b>	 <b>Confirm</b>	Set the date and time then confirm.	
  	<b>Settings</b> ↓ <b>Secondary page</b> ↓ <b>Screen settings</b>	<input checked="" type="checkbox"/> <b>Activate automatic text scrolling</b>	Activate or deactivate the setting then confirm.	
	<input checked="" type="checkbox"/> <b>Activate animations</b>			
	 <b>Confirm</b>			





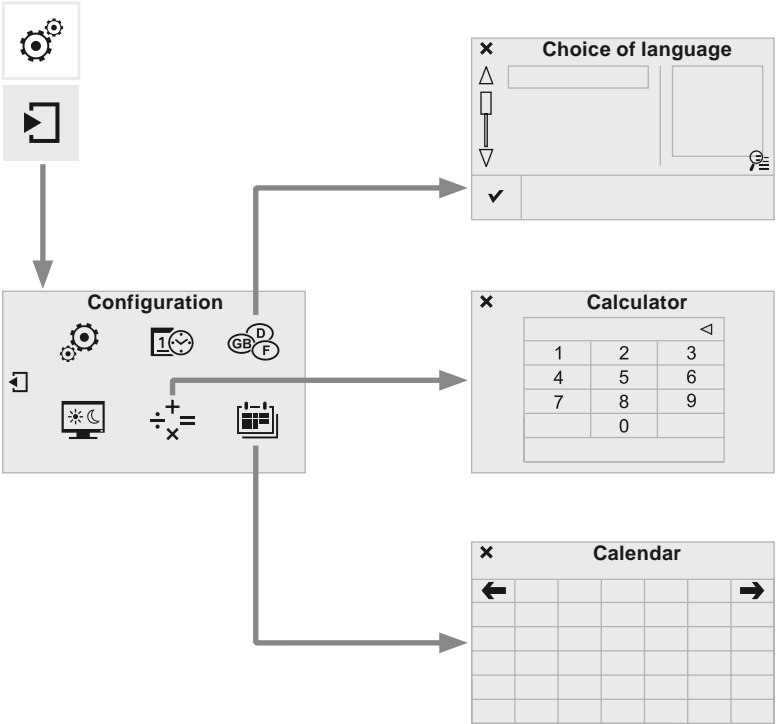





Level 1 | Level 2







Level 1		Level 2		Comments
  	<b>Settings</b> ↓ <b>Secondary page</b> ↓ <b>Languages</b>	✓	Confirm	Select the language then confirm.
  	<b>Settings</b> ↓ <b>Secondary page</b> ↓ <b>Calculator</b>			Select the calculator.
  	<b>Settings</b> ↓ <b>Secondary page</b> ↓ <b>Calendar</b>			Select the calendar.

## Audio settings



Press on **Settings** to display the primary page.



Select "**Audio settings**".



Select "**Ambience**".

Or



"**Balance**"

Or



"**Sound effects**"

Or



"**Ringtones**"

Or



"**Voice**".







**!** The distribution (or spatialisation using the Arkamys® system) of sound is an audio process that allows the audio quality to be adapted to the number of passengers in the vehicle. Available only with the 6-speaker configuration.





**i** The audio settings (**Ambience**, **Bass**, **Treble**: and **Loudness**) are different and independent for each sound source. The settings for **Distribution** and **Balance** are common to all sources.







- i**
- "**Ambience**" (choice of 6 musical ambiances)
  - "**Bass**:"
  - "**Treble**:"
  - "**Loudness**" (Activate/Deactivate)
  - "**Distribution**" ("**Driver**", "**All passengers**", "**Front only**")
  - "**Audible response from touch screen**"
  - "**Volume linked to speed**" (Activate/Deactivate)

**i** On-board audio: Arkamys® Sound Staging optimises sound distribution in the the passenger compartment.

## Modifying system settings

-  Press on **Settings** to display the primary page.
-  Press on the secondary page.
-  Select "**System Settings**".
-  Select "**Units**" to change the units of distance, fuel consumption and temperature.
-  Select "**Delete data**" to delete the list of recent destinations, personal points of interest, contacts in the list.
-  Choose the item then select "**Delete**".
-  Select "**Factory settings**" to return to the original settings.

-  Press on **Settings** to display the primary page.
-  Press on the secondary page.
-  Select "**Screen settings**".
-  Activate or deactivate "**Activate automatic text scrolling**" and "**Activate animations**".

-  Press on **Settings** to display the primary page.
-  Press on the secondary page
-  Select "**Time/Date**" to change the time zone, synchronisation with GPS, the time and its format, then the date.
-  Select "**Languages**" to change language.
-  Select "**Calculator**" to display a calculator.
-  Select "**Calendar**" to display a calendar.



# Connected services

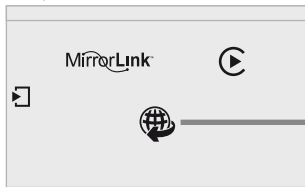

## Internet browser



Press on **Connected services** to display the primary page.











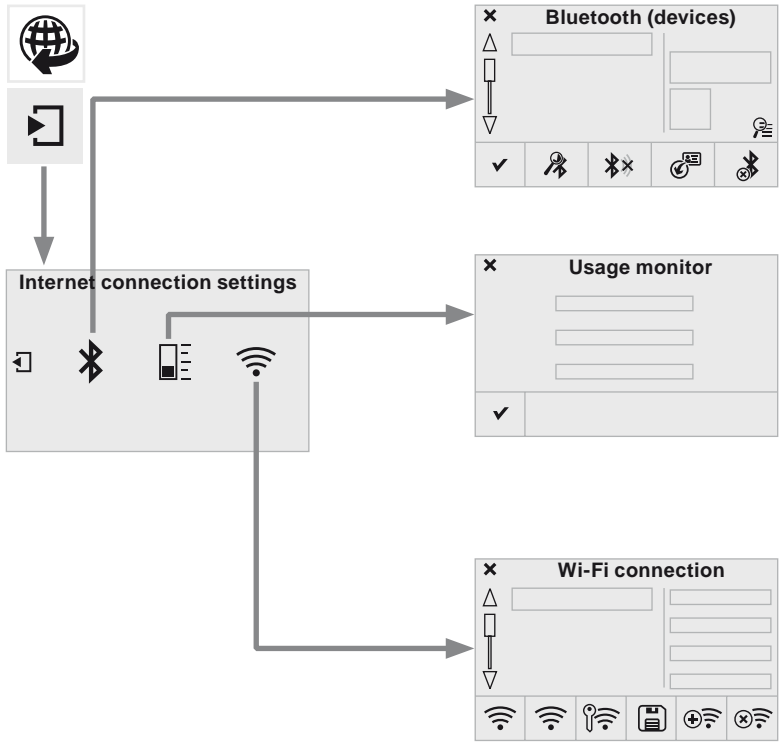













Press on "**Internet browser**" to display the browser home page; first connect your smartphone by Bluetooth, "Internet" option, see the "**Telephone**" section.

Authentication for Internet browsing via a smartphone is done using the Dial-Up Networking (DUN) standard.



Some smartphones of the latest generation do not support this standard.



Level 1		Level 2		Comments
  	<b>Connected services</b> ↓ <b>Secondary page</b> ↓ <b>Bluetooth connections</b>	 <b>Search</b>	Start the search for a device to connect.	
		 <b>Connect /Disconnect</b>	Start or end the Bluetooth connection to the selected device.	
		 <b>Update</b>	Import contacts from the selected telephone to save them in the audio system.	
		 <b>Delete</b>	Delete the selected telephone.	
		 <b>Confirm</b>	Save the settings.	
  	<b>Connected services</b> ↓ <b>Secondary page</b> ↓ <b>Transfer rate</b>	<b>Reset</b>	Reset the usage monitor, then confirm.	
		 <b>Confirm</b>		
  	<b>Connected services</b> ↓ <b>Secondary page</b> ↓ <b>Wi-Fi connection</b>	 <b>All</b>	Display all Wi-Fi networks.	
		 <b>Secure</b>	Display secure Wi-Fi networks.	
		 <b>Remember</b>	Memorise the selected Wi-Fi network(s).	
		 <b>Add</b>	Add a new Wi-Fi network.	
		 <b>On/ Off</b>	Activate or deactivate a Wi-Fi network.	
		 <b>Connect</b>	Select a Wi-Fi network found by the system and connect to it.	



# MirrorLink™

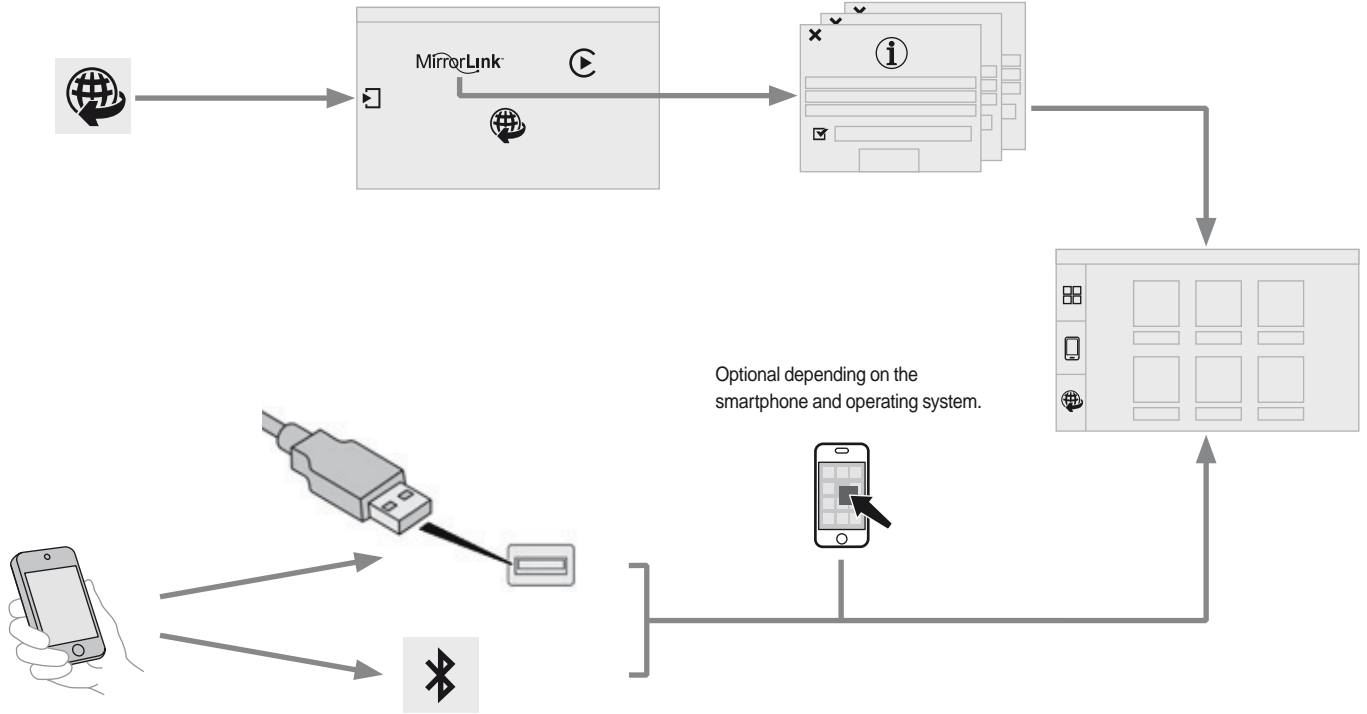



## MirrorLink™ smartphone connection

**!** As a safety measure and because it requires sustained attention by the driver, using a smartphone when driving is prohibited. All operations must be done with the **vehicle stationary**.

**i** The synchronisation of a smartphone allows applications on a smartphone that are adapted to the MirrorLink™ technology to be displayed in the vehicle's screen. The principles and standards are constantly evolving. For the communication process between the smartphone and the system to work correctly, the smartphone must be unlocked; update the operating system of your smartphone as well as the date and time in the smartphone and the system. For the list of eligible smartphones, connect to the brand's internet website in your country.

**!** As a safety measure, applications can only be viewed with the vehicle stationary; display is interrupted once the vehicle is moving.

**i** Please note:

- if your smartphone is supported, to make it "MirrorLink™" compatible, some phone manufacturers nevertheless invite you to first download a dedicated application.



When connecting a smartphone to the system, it is recommended that Bluetooth® be started on the smartphone.



Connect a USB cable. The smartphone charges when connected by a USB cable.



From the system, press on "**Connected services**" to display the primary page.



Press on "**MirrorLink™**" to start the application in the system.



Start the application on the smartphone (optional, depending on the smartphone and operating system).

**OK**

During the procedure, several screen pages relating to certain functions are displayed. Accept to start and end the connection.

Once connection is established, an page is displayed with the applications already downloaded to your smartphone and adapted to MirrorLink™ technology. If only one application has been downloaded to the smartphone, it starts automatically.

Access to the different audio sources remains accessible in the margin of the MirrorLink™ display, using touch buttons in the upper bar. Access to the menus for the system is possible at any time using the dedicated buttons





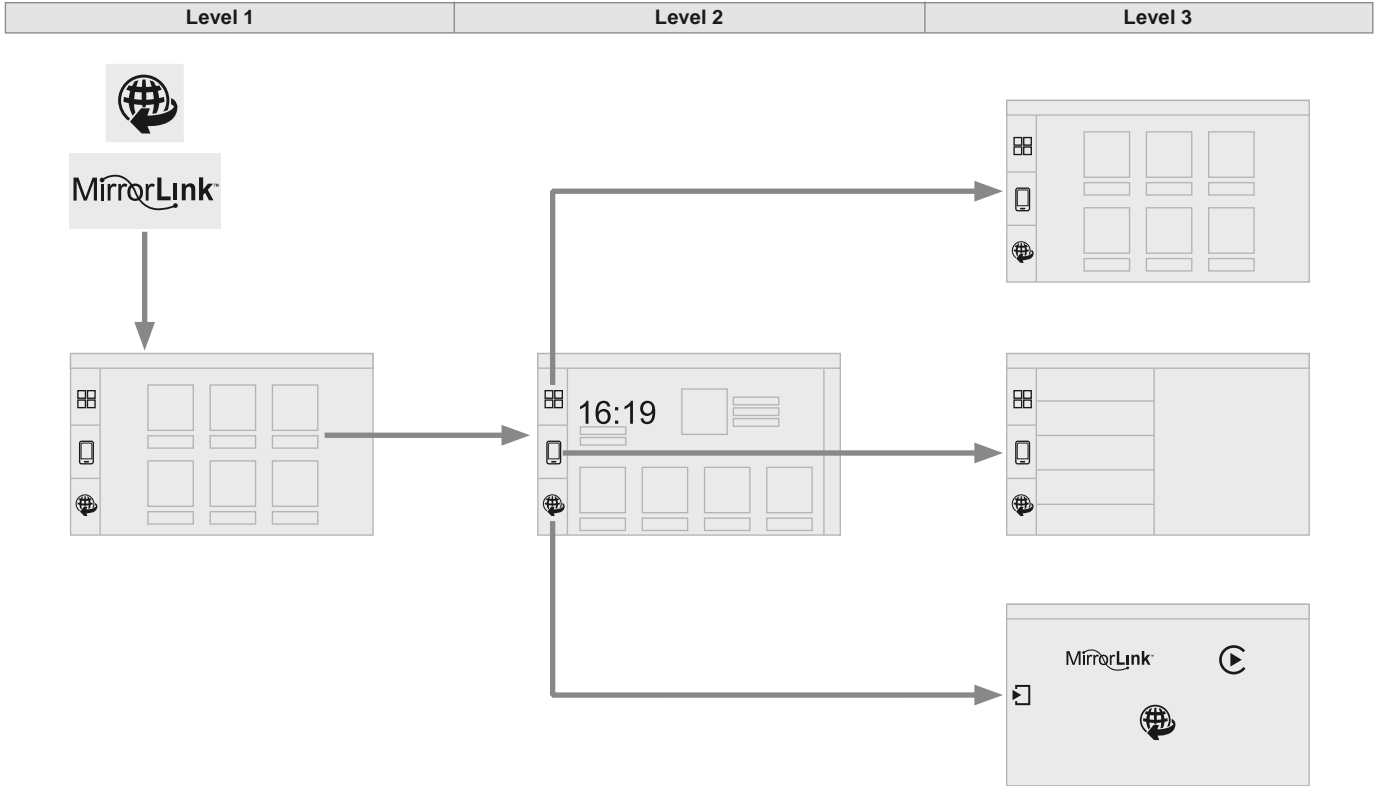

### Voice recognition

Press the end of the lighting control stalk to start voice recognition of your smartphone via the system.

Voice recognition requires a compatible smartphone connected to the vehicle by Bluetooth.





Level 1		Level 2		Level 3		Comments
 	<p><b>Connected services</b></p> <p>↓</p> <p><b>MirrorLink™</b></p>					Access or return to the applications already downloaded to your smartphone and adapted to MirrorLink™ technology.
						Access to a menu list depending on the application chosen. "Back": abandon the current operation, go up one level. "Home": access or return to the "Car mode" page.
						Access to the "Connected services" primary page.

# CarPlay®

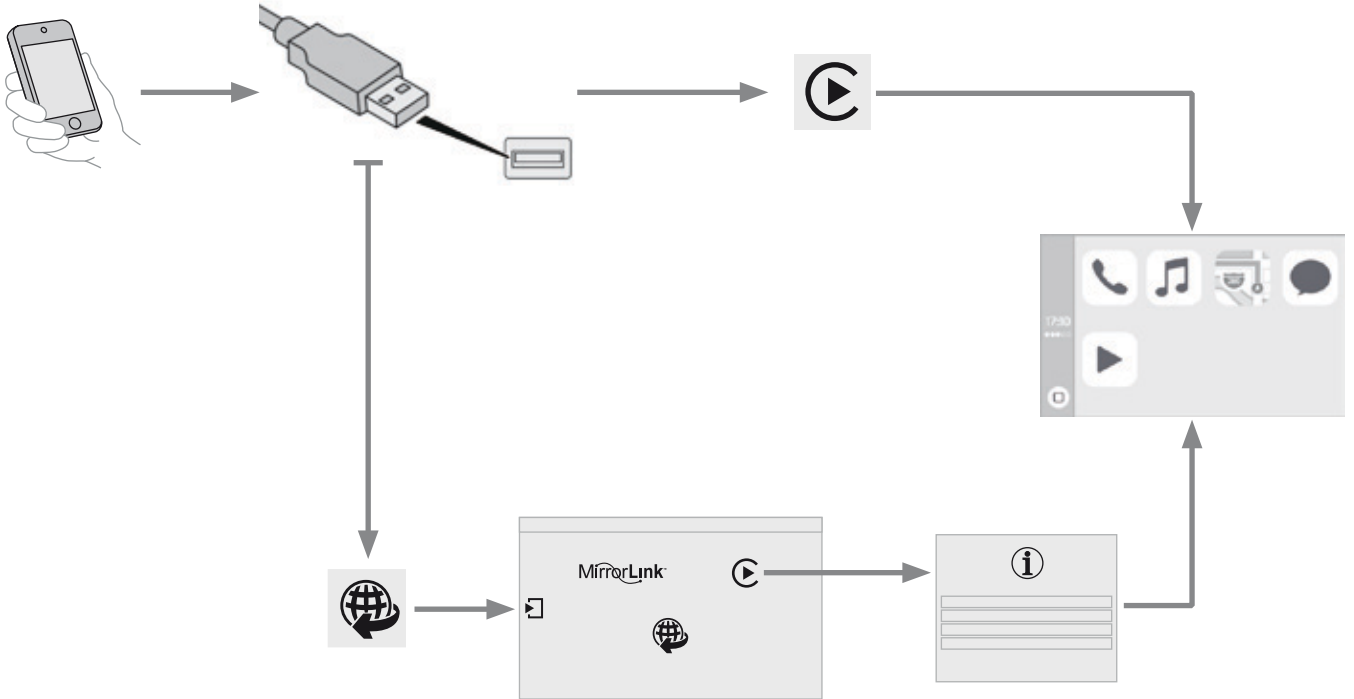

## CarPlay® smartphone connection

**!** As a safety measure and because it requires sustained attention by the driver, using a smartphone when driving is prohibited.  
All operations must be done with the **vehicle stationary**.

**i** The synchronisation of a smartphone allows applications on a smartphone that are adapted to the CarPlay® technology to be displayed in the vehicle's screen.  
As the principles and standards are constantly evolving, it is recommended that you update the operating system of your smartphone.  
For the list of eligible smartphones, connect to the brand's internet website in your country.

**i** As a safety measure, applications can only be viewed with the vehicle stationary; display is interrupted once the vehicle is moving.



Connect a USB cable. The smartphone charges when connected by a USB cable.



On connecting the USB cable, the "**Telephone**" function changes to "**CarPlay**" in the menu carousel. Press on "**CarPlay**" to display the CarPlay® interface.

Or



Connect the USB cable. The smartphone is charged while connected by the USB cable.



From the system, press on "**Connected services**" to display the primary page.



Press on "**CarPlay**" to display the CarPlay® interface.





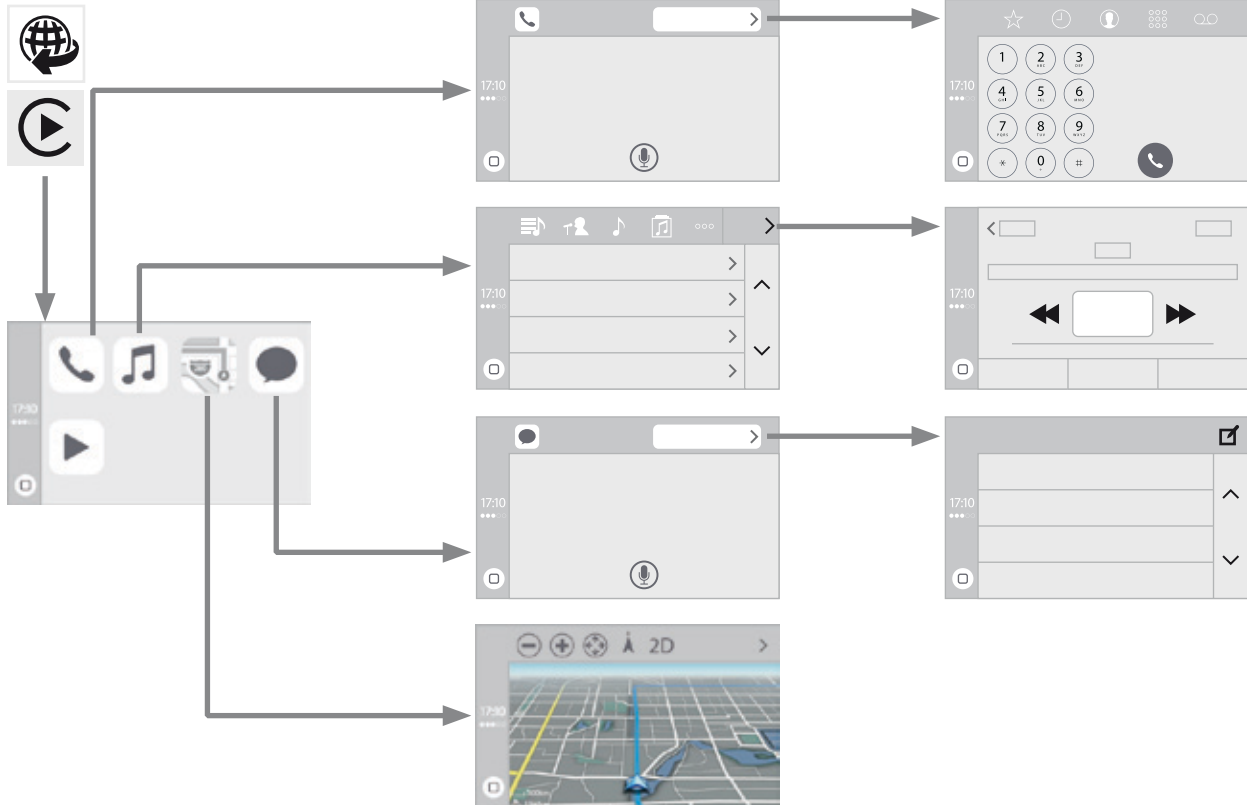

**i** During the procedure, one or more screen pages relating to certain functions are displayed on connection.

## Voice recognition

Press the end of the lighting control stalk to start voice recognition of your smartphone via the system.

Level 1    Level 2    Level 3







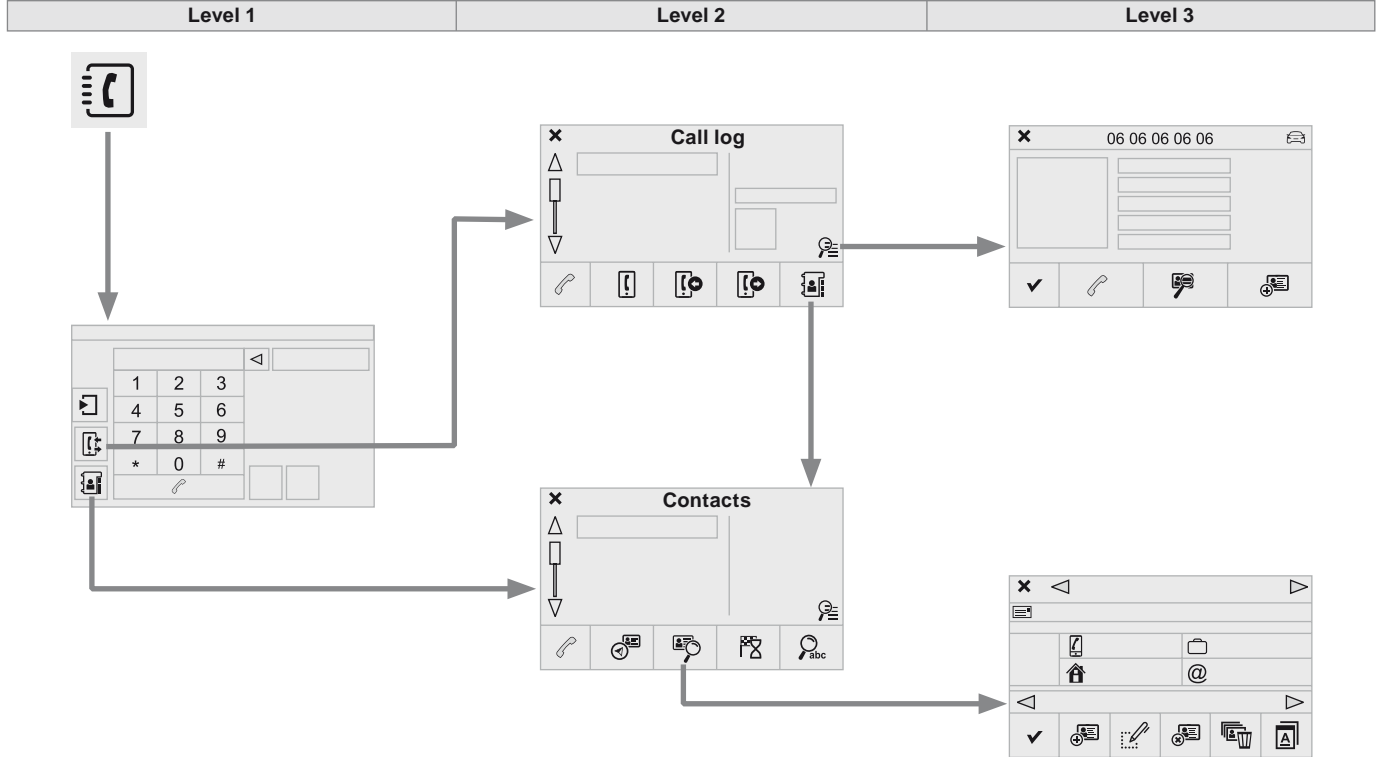

















Level 1		Level 2		Level 3		Comments	
 <b>Connected services</b>  <b>Apple® CarPlay®</b>	 <b>Telephone</b>		☆ <b>Favourites</b>			<p>The "Telephone" function is placed automatically in "Siri" voice mode. Press on "Display contacts" for access to the telephone menus.</p>	
			⏪ <b>Calls</b>				
			👤 <b>Contacts</b>				
			☰ <b>Keypad</b>				
			💬 <b>Messages</b>				
	 <b>Music</b>			📁 <b>Lists</b>			<p>Press on "Music" to browse and select the tracks on your smartphone. Press on "Playing" for access to the track currently playing.</p>
				👤 <b>Artists</b>			
				🎵 <b>Tracks</b>			
				📀 <b>Albums</b>			
	 <b>Plan</b>			> <b>Destinations</b>			<p>Press on "Destinations" to search for an address by "Siri" voice command or by using the keypad. The GPS function is through the telephone's 3G, 4G or Wi-Fi internet connection.</p>
				 <b>Messages</b>			
	▶ <b>Playing</b>						Access to the track currently playing.

# Telephone











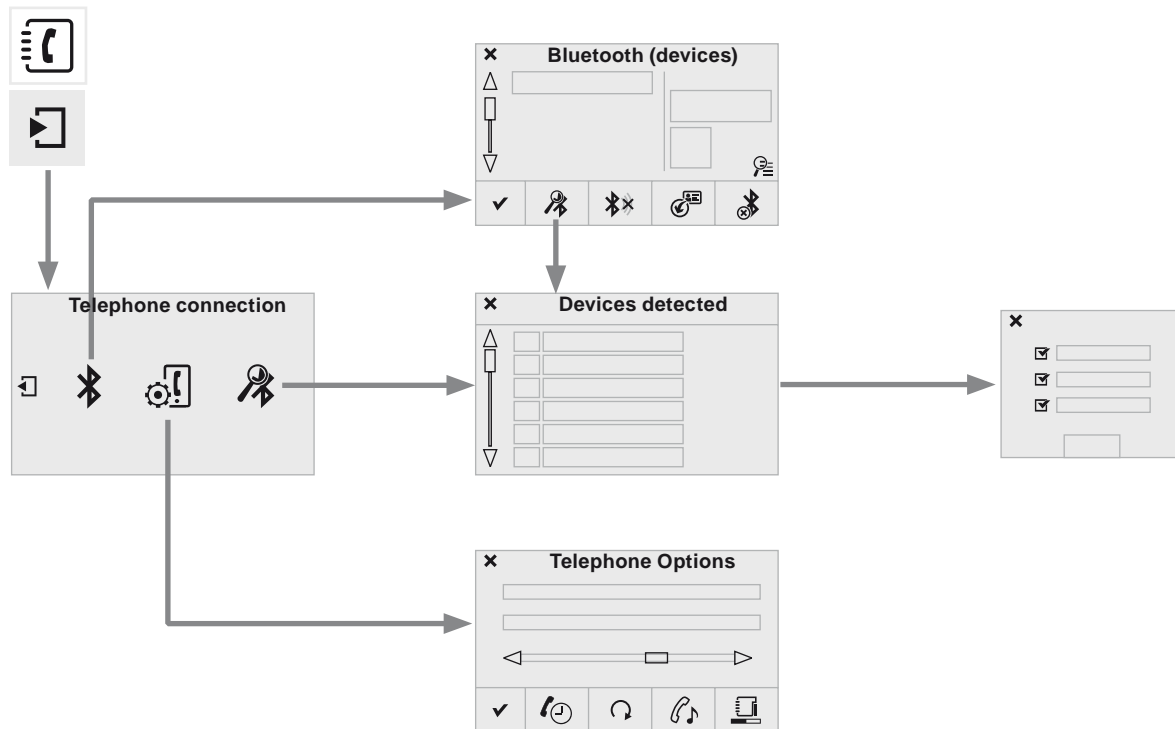













Level 1		Level 2		Level 3		Comments
 	<p>Telephone ↓ Call log</p>	 All calls				After making choices, start the call.
		 Incoming calls				
		 Outgoing calls				
		 Contacts				
		 Magnifying glass	 View			
			 Create			
 Call						
 	<p>Telephone ↓ Contacts</p>	 Addresses				After making choices, start the call.
		 View	 Create			
			 Modify			
			 Delete			
			 Delete all			
			 By name			
			 Confirm			
		 Navigate to				
		 Search for contact				
 Call						



Level 1	Level 2	Level 3
---------	---------	---------



Level 1		Level 2		Level 3		Comments
  	Telephone connection ↓ Secondary page ↓ Bluetooth connection	 Search				Start the search for another peripheral device to connect.
		 Connect / Disconnect				Start or stop the Bluetooth connection to the selected peripheral device.
		 Update				Import the contacts from the selected telephone to store them in the audio system.
		 Delete				Delete the selected telephone.
		 Confirm				Save the settings.
  	Telephone connection ↓ Secondary page ↓ Search for devices			<input checked="" type="checkbox"/> Telephone		Start the search for peripheral devices.
		Devices detected		<input checked="" type="checkbox"/> Audio streaming		
				<input checked="" type="checkbox"/> Internet		
  	Telephone connection ↓ Secondary page ↓ Telephone Options	 Put on hold				Cut the microphone temporarily so that the contact cannot hear your conversation with a passenger.
		 Update				Import the contacts from the selected telephone to save then in the audio system.
		 Ringtones				Choose the telephone ringtone and volume.
		 Memory info.				Contact records used and free, percentage of storage space used by internal contacts and Bluetooth contacts.
		 Confirm				Save the settings.

## Pairing a Bluetooth® telephone

**!** For reasons of safety and because they require prolonged attention on the part of the driver, the operations for pairing the Bluetooth mobile telephone to the hands-free system of the audio system must be carried out with the **vehicle stationary**.

### Procedure (short) from the telephone

In the Bluetooth menu of your device, select the system name in the list of devices detected.

Enter a code of at least 4 figures in the device and confirm.



Enter this same code in the system, select **"OK"** and confirm.

### Procedure from the system

Activate the telephone's Bluetooth function and ensure that it is "visible to all" (telephone configuration).



Press on **Telephone** to display the primary page.



Press on the secondary page.



Select **"Bluetooth connection"**.



Select **"Search for devices"**.  
The list of telephones detected is displayed.



If the telephone is not detected, it is recommended that you switch the Bluetooth function on your telephone off and then on again.

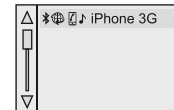

Select the name of the desired peripheral from the list and **"Confirm"**.



Enter a code of at least 4 figures for the connection then **"Confirm"**.

Enter this same code in the telephone then accept the connection.

The system offers to connect the telephone:

- in **"Telephone"** (hands-free kit, telephone only),
- in **"Audio streaming"** (streaming: wireless playing of audio files from the telephone),
- in **"Internet"** (internet browsing, only if your telephone is compatible with the "DUN" Dial-Up Networking Bluetooth standard).

Select one or more profiles and confirm.

! The services available depend on the network, the SIM card and the compatibility of the Bluetooth telephone used. Check the telephone manual and with your network provider for details of the services available to you.

! The ability of the system to connect with only one profile depends on the telephone. The three profiles may all connect by default.

Visit [www.peugeot.co.uk](http://www.peugeot.co.uk) for more information (compatibility, additional help, ...).



The recognised telephone appears in the list.

Depending on your telephone, you may be asked to accept automatic connection every time the ignition is switched on.

! Depending on the type of telephone, the system will ask you to accept or not the transfer of your contacts.



If not, select "**Update**".

On return to the vehicle, if the last telephone connected is present again, it is reconnected automatically and within around 30 seconds after switching on the ignition the pairing is done without any action on your part, with (Bluetooth activated).

To modify the automatic connection mode, select the telephone in the list then select the desired profile.

## Connecting a Bluetooth® peripheral device

### Automatic reconnection

On switching on the ignition, the telephone connected when the ignition was last switched off is automatically reconnected, if this connection mode had been activated during the pairing procedure.

The connection is confirmed by the display of a message and the name of the telephone.

### Manual connection



Press on **Telephone** to display the primary page.



Press on the secondary page.



Select "**Bluetooth**" to display the list of paired peripherals.

Select the peripheral to connect.



Press on "**Search for devices**".

The connection is confirmed by the display of a message and the name of the telephone.

## Managing paired telephones

**i** This function allows the connection or disconnection of a peripheral device as well as the deletion of a pairing.



Press on **Telephone** to display the primary page.



Press on the secondary page.



Select "**Bluetooth**" to display the list of paired peripheral devices.

Select the peripheral in the list.



Select "**Search for devices**"

Or



"**Connect / Disconnect**" to start or end the Bluetooth connection with the selected device.

Or



"**Delete**" to delete the pairing.

## Receiving a call

An incoming call is announced by a ring and a superimposed display in the screen.



Make a short press on the steering mounted **TEL** button to accept an incoming call.



Make a long press



on the steering mounted **TEL** button to reject the call.

Or



Select "**End call**".

## Making a call

**!** Using the telephone is not recommended while driving. Park the vehicle. Make the call using the steering mounted controls.

### Calling a new number



Press on **Telephone** to display the primary page.



Enter the phone number using the digital keypad. Press "**Call**" to start the call.

### Calling a contact



Press on **Telephone** to display the primary page.



Or make a long press



on the steering mounted **TEL** button.



Select "**Contacts**".

Select the desired contact from the list offered.



Select "**Call**".

## Calling a recently used number



Press on **Telephone** to display the primary page.



Select "**Call log**".

Select the desired contact from the list offered.



It is always possible to make a call directly from the telephone; park the vehicle first as a safety measure.

## Managing contacts / entries



Press on **Telephone** to display the primary page.



Select "**Contacts**".



Select "**View**".



Select "**Create**" to add a new contact.

Or



"**Modify**" to edit the selected contact.

Or



"**Delete**" to delete the selected contact.

Or



"**Delete all**" to delete all information for the selected contact.



Select "**By name**" to view the list of contacts.

## Frequently asked questions

The following table groups together the answers to the most frequently asked questions concerning your audio system.

### Navigation

QUESTION	ANSWER	SOLUTION
The route calculation is not successful.	The route settings may conflict with the current location (exclusion of toll roads on a toll motorway).	Check the route settings in the "Navigation" menu.
The POIs do not appear.	The POIs have not been selected.	Select the POIs in the list of POIs.
The Risk areas audible warning does not work.	The audible warning is not active.	Activate audible warnings in the "Navigation" menu.
The system does not suggest a detour around an incident on the route.	The guidance criteria do not take account of TMC messages.	Select the "Information" function in the list of route settings.
I receive a Risk areas alert which is not on my route.	Other than guidance, the system announces all Risk areas positioned in a cone located in front of the vehicle. It may provide an alert for Risk areas located on nearby or parallel roads.	Zoom in on the map to view the exact position of the Risk areas. Select "On the route" to no longer receive alerts other than navigation instructions or to reduce the time for the announcement.



QUESTION	ANSWER	SOLUTION
Certain traffic jams along the route are not indicated in real time.	On starting, it is several minutes before the system begins to receive the traffic information.	Wait until the traffic information is being received correctly (display of the traffic information icons on the map).
	The filters are too restrictive.	Modify the settings.
	In certain countries, only major routes (motorways...) are listed for the traffic information.	This phenomenon is normal. The system is dependent on the traffic information available.
The altitude is not displayed.	On starting, the initialisation of the GPS may take up to 3 minutes to receive more than 4 satellites correctly.	Wait until the system has started up completely so that there is GPS coverage by at least 4 satellites.
	Depending on the geographical environment (tunnel...) or the weather, the conditions of reception of the GPS signal may vary.	This phenomenon is normal. The system is dependent on the GPS signal reception conditions.

## Radio

QUESTION	ANSWER	SOLUTION
The quality of reception of the radio station listened to gradually deteriorates or the stored stations do not function (no sound, 87.5 Mhz is displayed...).	The vehicle is too far from the transmitter used by the station listened to or there is no transmitter in the geographical area through which the vehicle is travelling.	Activate the "RDS" function by means of the short-cut menu to enable the system to check whether there is a more powerful transmitter in the geographical area.
	The environment (hills, buildings, tunnels, basement car parks...) block reception, including in RDS mode.	This phenomenon is normal and does not indicate a fault with the audio system.
	The aerial is absent or has been damaged (for example when going through a car wash or into an underground car park).	Have the aerial checked by a PEUGEOT dealer.
I cannot find some radio stations in the list of stations received.	The station is not received or its name has changed in the list.	Press and hold the "List" button at the steering mounted controls to update the list of stations received or press on the system update function: "Update list".
The name of the radio station changes.	Some radio stations send other information in place of their name (the title of the song for example).	
	The system interprets this information as the name of the station.	

## Media

QUESTION	ANSWER	SOLUTION
Playback of my USB memory stick starts only after a very long wait (around 2 to 3 minutes).	Some files supplied with the memory stick may greatly slow down access to reading the memory stick (multiplication by 10 of the catalogue time).	Delete the files supplied with the memory stick and limit the number of sub-folders in the file structure on the memory stick.
When I connect my iPhone as a telephone and to the USB port at the same time, I am unable to play the music files.	When the iPhone connects automatically as a telephone, it forces the streaming function. The streaming function takes the place of the USB function which is then not useable, there is a period without sound of the track being played with Apple® players.	Disconnect and reconnect to the USB port (the USB function takes priority over streaming).
The CD is ejected automatically or is not played by the player.	The CD is inserted upside down, is unplayable, does not contain any audio data or contains an audio format which the player cannot play.	Check that the CD is inserted in the player the right way up. Check the condition of the CD: the CD cannot be played if it is too badly damaged. Check the content in the case of a recorded CD: refer to the advice in the "AUDIO" section. The audio system's CD player does not play DVDs. Some recorded CDs will not be played by the audio system because they are not of adequate quality.
	The CD has been recorded in a format that is not compatible with the player (udf...).	
	The CD is protected by an anti-pirating protection system which is not recognised by the audio system.	
There is a long waiting period following the insertion of a CD or connection of a USB memory stick.	When a new medium is inserted, the system reads a certain amount of data (directory, title, artist, etc.). This may take from a few seconds to a few minutes.	This phenomenon is normal.

QUESTION	ANSWER	SOLUTION
The CD player sound is poor.	The CD used is scratched or of poor quality.	Insert good quality CDs and store them in suitable conditions.
	The audio equipment settings (bass, treble, ambiences) are unsuitable.	Set the treble or bass level to 0, without selecting an ambience.
Some characters in the media information are not displayed correctly while playing.	The audio system does not display some types of characters.	Use standard characters to name tracks and folders.
Playing of streaming files does not start.	The peripheral device connected does not support automatic play.	Start the playback from the device.
The names of tracks and the track length are not displayed on the screen when streaming audio.	The Bluetooth profile does not allow the transfer of this information.	



## Settings

QUESTION	ANSWER	SOLUTION
In changing the setting of treble and bass the equalizer setting is deselected.	The selection of an equalizer setting imposes the balance settings. Modifying one without the other is not possible.	Modify the balance or equalizer settings to obtain the desired musical ambience.
In changing the equalizer setting, treble and bass return to zero.		
When changing the balance settings, the distribution setting is deselected.	The selection of a distribution setting imposes the balance settings. Modifying one without the other is not possible.	Modify the balance or distribution settings to obtain the desired musical ambience.
When changing an distribution setting, the balance setting is deselected.		

QUESTION	ANSWER	SOLUTION
There is a difference in sound quality between the different audio sources.	For optimum sound quality, the audio settings for Loudness, Ambience, Treble, Bass, Volume can be adapted to the different sound sources, which may result in audible differences when changing source.	Check that the audio settings (Loudness, Ambience, Treble, Bass, Volume) are adapted to the sources listened to. Adjust Balance, Treble and Bass to the middle position, select the "None" musical ambience and set the loudness correction to the "Active" position in CD mode or to the "Inactive" position in radio mode.
With the engine off, the system switches off after a few minutes of use.	When the engine is switched off, the system's operating time depends on the state of charge of the battery. The switch-off is normal: the system switches to economy mode and switches off to prevent discharging of the vehicle's battery.	Start the vehicle's engine to increase the battery charge.

## Telephone

QUESTION	ANSWER	SOLUTION
I cannot connect my Bluetooth telephone.	The telephone's Bluetooth function may be switched off or the telephone may not be visible.	Check that your telephone's Bluetooth function is switched on. Check in the telephone settings that it is "visible to all".
	The Bluetooth telephone is not compatible with the system.	You can check the compatibility of your telephone at <a href="http://www.peugeot.co.uk">www.peugeot.co.uk</a> (services).
The volume of the telephone connected in Bluetooth mode is inaudible.	The volume depends both on the system and on the telephone.	Increase the volume of the audio system, to maximum if required, and increase the volume of the telephone if necessary.
	The ambient noise level has an influence on the quality of telephone communication.	Reduce the ambient noise level (close the windows, reduce the booster fan speed, slow down...).
Some contacts are duplicated in the list.	The options for synchronizing contacts are synchronizing the contacts on the SIM card, the contacts on the telephone, or both. When both synchronizations are selected, some contacts may be duplicated.	Select "Display SIM card contacts" or "Display telephone contacts".
Contacts are not shown in alphabetical order.	Some telephones offer display options. Depending on the settings chosen, contacts can be transferred in a specific order.	Modify the display setting in the telephone directory.
The system does not receive SMS text messages.	The Bluetooth mode does not permit sending SMS text messages to the system.	

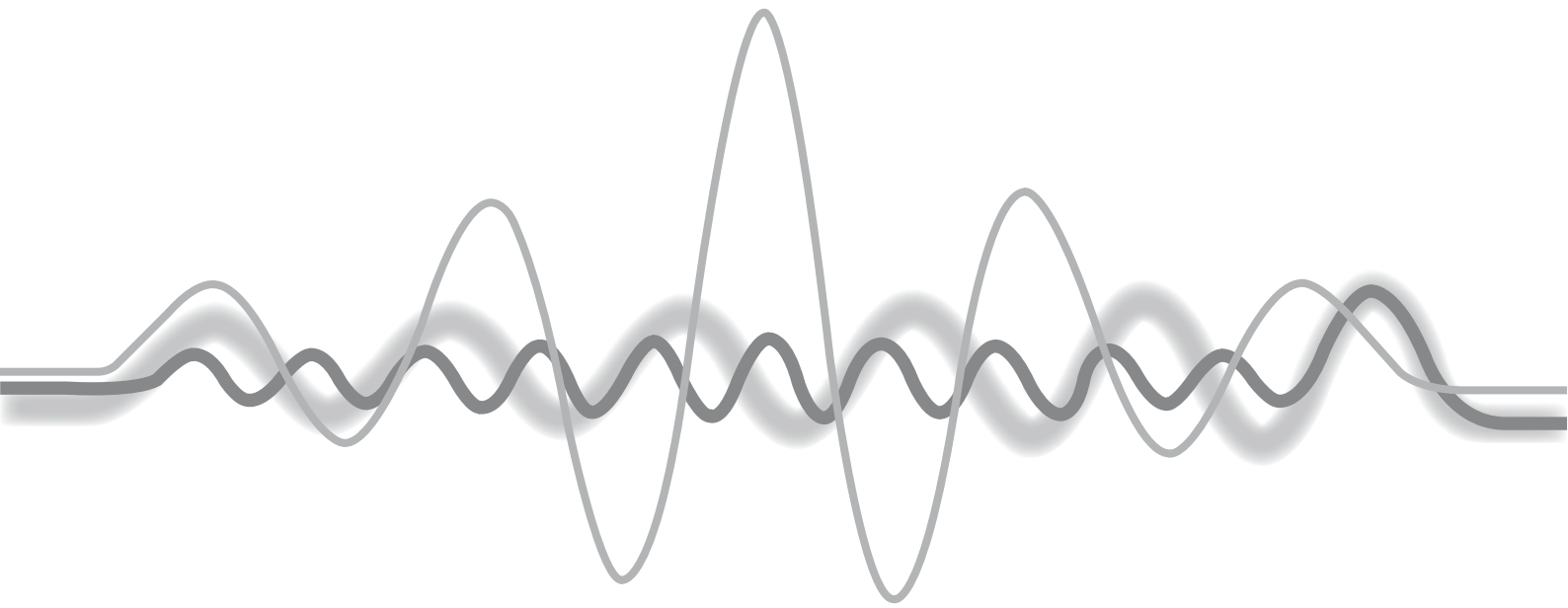



# Audio system / Bluetooth®

10



	Contents
First steps	296
Steering mounted controls	297
Radio	298
Media	300
Telephone	304
Audio settings	307
Configuration	308
Screen menu map(s)	309
Frequently asked questions	310

! As a safety measure, the driver must only carry out operations which require prolonged attention while the vehicle is stationary. When the engine is switched off and to prevent discharging of the battery, the system switches off after activation of energy economy mode.

# First steps



On / Off, volume adjustment.



Select the source:  
 Radio: FM1, FM2, AM, CD, USB, AUX, Streaming.  
 Telephone: accept an incoming call.  
 Telephone, press and hold: end a call, access the calls log for the connected telephone.



Adjust audio settings: sound ambience, treble, bass, loudness, distribution, left/right balance, front/rear balance, automatic volume.



Automatic search for a lower radio frequency.  
 Select the previous CD, USB track.  
 Navigation in a list.  
 Press and hold: fast back.



Display the list of stations received, the CD/USB tracks or folders.  
 Press and hold: update the list of stations received.



Abandon the current operation.  
 Go up one level (menu or folder).



Automatic search for a higher radio frequency.  
 Select the next CD, USB track.  
 Navigation in a list.  
 Press and hold: fast forward.



Open the main menu.



Select a preset radio station.  
 Radio, press and hold: preset a radio station.  
 Other than radio: see the corresponding sections.



Eject CD.

# Steering mounted controls



Radio: select the previous / next preset station.  
 CD / USB: select the genre / artist / folder / playlist from the list depending on classification.  
 Select the previous / next item in a menu.



Radio: automatic search for a higher frequency.  
 CD / MP3 / USB: select the next track.  
 CD / USB: press and hold: fast forward.



Change the audio sound.  
 Confirm a selection.  
 Start/end call with the telephone.  
 Press and hold: access to the call log.



Radio: automatic search for a lower frequency.  
 CD / MP3 / USB: select the previous track.  
 CD / USB: press and hold: fast back.



Volume increase.



Volume decrease.



Mute: cut the sound by simultaneously pressing the volume increase and decrease buttons.  
 Restore the sound: by pressing one of the two volume buttons.

# Radio

## Presetting a station

 Press **SRC/TEL** repeatedly to select the FM1, FM2 or AM waveband.

 Press and hold one of the buttons to preset the station being listened to. The name of the station is displayed and an audible signal confirms the preset.

**i** The exterior environment (hills, buildings, tunnel, car park, below ground...) may prevent reception, even in RDS station tracking (alternative frequencies) mode. This phenomenon is normal in the propagation of radio waves and is in no way indicative of a fault with the audio system.

## Selecting a station

 Press a button to listen to the corresponding preset station.

## Managing a list

 Press **LIST** to display the list of stations received in alphabetical order.

 Select the desired radio station using one of the buttons.

 Confirm with "**OK**".

 Briefly press one of the buttons to change to the next or previous letter.

 Press and hold on **LIST** to build or update the list of stations; audio reception is cut momentarily.

## Entering a frequency

 Press on **MENU**.

 Select "**Radio**".

 Select "**Write freq.**".

 Press **+**.

or

 press **-** to select the desired frequency.

 Confirm with "**OK**".

## RDS

**i** RDS, if activated, enables you to continue listening to the same station by automatic retuning to alternative frequencies. However, in certain conditions, coverage of an RDS station may not be assured throughout the country as radio stations do not cover 100 % of the territory. This explains the loss of reception of the station during a journey.

**MENU** With source FM1 or FM2, press **MENU**.

 Select "**Radio**".

 Select or deselect "**RDS**" to switch RDS on or off.

**OK** Confirm with "**OK**" to save the setting.

## Receiving TA messages

**i** The TA (Traffic Announcement) function gives priority to TA alert messages. To operate, this function needs good reception of a radio station transmitting this type of message. When a traffic report is transmitted, the current audio source (Radio, CD, USB, ...) is interrupted automatically to play the TA message. Normal playback of the audio source resumes at the end of the transmission of the message.

**MENU** Press **MENU**.

 Select "**Radio**".

 Select or deselect "**TA**" to activate or deactivate the reception of traffic messages.

**OK** Confirm with "**OK**" to save the setting.

## Displaying RADIO TEXT

**i** Radio text is information transmitted by the radio station related to the current programme or song.

**MENU** With the radio displayed on the screen, press **MENU**.

 Select "**Radio**".

 Select or deselect "**TXT**" to activate or deactivate the display of Radio Text.

**OK** Confirm with "**OK**" to save the setting.

# Media

## USB player



This unit comprises a USB port and a Jack auxiliary socket, depending on model.

**!** The system constitutes playlists (in temporary memory) the creation time for which can be from a few seconds to several minutes at the first connection. Limiting the number of non-music files and the number of folders reduces this waiting time. The playlists are updated every time the ignition is switched off or a USB memory stick is connected. The lists are memorised: if there is no change in the lists, the next loading time will be shorter.

**i** At a first connection, the order suggested is by folder. When connecting again, the order previously chosen is retained.

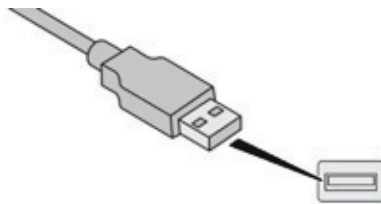

Connect a USB memory stick to the USB port or connect a USB device to the USB port using a suitable cable (not supplied).

**SRC / /**

Press **SRC/TEL** repeatedly to select "**USB**".



Press one of these buttons to select the next or previous track in the list.



Press one of these buttons to select the next or previous folder in the order chosen.



Press and hold one of these buttons for fast forward or back.

**LIST**

Press **LIST** to display the structure of the folders in the compilation.



Select a line in the list.

**OK**

Confirm with "**OK**".



Up a level in the menu.

**MENU**

Press **MENU**.



Select "**Media**".



Select or deselect "**TA**" to switch traffic announcements on or off.



Select the play mode: "**Normal**", "**Random**", "**Random all**" or "**Repeat**".

## Auxiliary socket (AUX)



Connect the portable device (MP3 player...) to the Jack auxiliary socket using an audio cable (not supplied).

Press **SRC/TEL** repeatedly to select "**AUX**".

First adjust the volume on the portable device (to a high level). Then adjust the volume on your audio system. Control is from the portable device.

! Do not connect a given device to both the Jack auxiliary socket and the USB port at the same time.

## CD player

Insert a CD into the player, play starts automatically.

Insert an MP3 compilation CD into the CD player.

The audio system searches for audio tracks, which can take from a few to several dozen seconds before play starts.

Press the **SRC/TEL** button repeatedly to select "**CD**".

Press one of these buttons to go to the previous or next track in the list.

Press one of these buttons to select the previous or next folder according to the category chosen.

Press and hold one of these buttons for fast forward or back.

**LIST**

Press **LIST** to display the folder structure of the compilation.



Select a line in the list.

**OK**

Confirm with "**OK**".

Return to the top level of the folder structure to select the type of tracks.

- By **Folders** (CD or USB): all folders containing audio files recognised on the peripheral device, in alphabetical order without following the folder structure.
- By **Artist** (USB only): all of the artist names defined in the ID3 Tags, in alphabetical order.
- By **Genre** (USB only): all of the genres defined in the ID3 Tags.
- By **Playlist** (CD or USB): if playlists have been saved.

## Information and advice

The audio system will only play files with ".mp3", ".wma" and ".wav" on a CD and can play files with ".ogg" extension only on USB.

It is recommended that file names be of no more than 20 characters and avoiding special characters (ex : " ? ; ù) so as to avoid any problem reading or displaying the files.

In order to be able to play a recorded CDR or CDRW, when recording it is preferable to select standards ISO 9660 level 1.2 or Joliet.

If the disc is recorded in another format, it may not be played correctly.

It is recommended that the same recording standard is always used for an individual disc, with as low a speed as possible (4x maximum) for optimum sound quality.

In the particular case of a multi-session CD, the Joliet standard is recommended.

The playlists accepted on CD, MP3, iPod and USB connection are types ".m3u" and ".wpl". The number of files recognised is limited to 5 000 in 500 folders on a maximum of 8 levels.

On a single disc, the CD player can read up to 255 MP3 files spread over 8 folder levels with a maximum of 192 folders. However, it is recommended that this be kept to 2 levels so as to limit the time taken to access and play the CD.

During play, the folder structure is not observed.

Do not connect a hard disk or USB device other than audio players to the USB port. This may cause damage to your installation.

Use only USB memory sticks formatted FAT32 (File Allocation Table).

**i** The use of genuine Apple® USB cables is recommended to ensure correct operation.





## Bluetooth® audio streaming

Streaming allows music files on a telephone to be heard via the vehicle's speakers.

Connect the telephone: see the "**Telephone**" section.

In the "**Bluetooth: Audio**" menu, select the telephone to connect.  
The audio system connects automatically to a newly paired telephone.

**SRC /**

Activate the streaming source by pressing the **SRC/TEL\*** button.

Control of playback is via the audio system. The control of common tracks is possible via the audio system control buttons and the steering mounted controls\*\*. Contextual information can be displayed in the screen.

The audio quality depends on the quality of the transmission from the telephone.

\* In certain cases, the play of audio files must be initiated from the keypad.

\*\* If the telephone supports the function.

## Connecting Apple® players

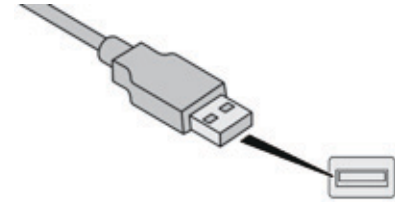

Connect the Apple® player to the USB port using a suitable cable (not supplied). Play starts automatically.

Management of the device is via the audio system controls.

The classifications available are those on the portable player connected (artists / albums / genres / playlists/ audiobooks / podcasts).

The software version of the audio system may not be compatible with the generation of your Apple® player.

# Telephone

## Pairing a Bluetooth telephone

**!** For safety reasons and because they require prolonged attention on the part of the driver, the operations for pairing of the Bluetooth mobile telephone with the Bluetooth hands-free system of your audio system must be carried out with the vehicle stationary and the ignition on.

Visit [www.peugeot.co.uk](http://www.peugeot.co.uk) for more information (compatibility, more help, ...).

Activate the telephone's Bluetooth function and ensure that it is set as visible to all (refer to the telephone instructions).



**MENU**

Press the **MENU** button.



Select **"Bluetooth"**.



Select **"Search"**.

A window is displayed with **"Searching device"**.

**i** The services available depend on the network, the SIM card and the compatibility of the Bluetooth telephone used. Consult your telephone's manual and your operator to find out which services are available to you.



Select the telephone to be paired from the list.



**OK**

Confirm with **"OK"**.

Only one telephone can be paired at a time.

In some cases, the Bluetooth address of the telephone may appear instead of the name of the telephone.



A virtual keypad is displayed on the screen: choose a 4 digit code.



**OK**

Confirm with **"OK"**.

A message is displayed in the screen of the telephone: enter the same code and confirm.

If pairing fails, try again; the number of attempts is not limited.

A message appears in the screen to confirm the result of the connection.

**i** Pairing can also be initiated from the telephone by searching for detected Bluetooth devices.

**i** The directory and the calls list can be accessed after the synchronisation period (if the telephone is compatible). Automatic connection must be configured in the telephone to allow the connection each time the vehicle is started.



## Managing connections



Press the **MENU** button.



Select "**Bluetooth**".



Select "**BT management**" and confirm. The list of paired telephones is displayed.



Indicates connection of the audio profile.



Indicates connection of the hands-free profile.



In the list, select a telephone to pair.



Confirm with "**OK**".



Select or deselect:

- "**Tel.**": hands-free connection
- "**Audio**": play audio files



"**OK**" to confirm the choice.



"**Delete**" to delete the pairing.



It is not possible to pair more than 5 telephones. Press **MENU** and select "**Bluetooth**". Select "**BT management**". If 5 telephones are already paired, select the telephone to delete by pressing "**OK**" and selecting "**Delete**" (refer to the "Managing connections" section).

## Making a call

### From the directory



Press the **MENU** button.



Select "**Telephone**".



Select "**Call**".



Select "**Directory**".



Select the desired number.



Confirm with "**OK**" to start the call.

## Making a call

### Recently called numbers\*

 Press and hold **SRC/TEL** to display the calls list.

**i** For access to the calls list, it is also possible to press **MENU**, select "**Telephone**", then select "**Call**", and finally select "**Calls list**".

 In the list of calls, select the number and choose "**Missed calls**", "**Dialed calls**" or "**Answered calls**".

 Scroll through the calls list.

**OK** Confirm with "**OK**".

 Press one of these buttons to go to the previous or next page in the list.

**OK** "**OK**" starts the call.

**i** The calls list includes the calls sent from and by from the vehicle via the connected telephone. It is possible to make a call directly from the telephone; stop the vehicle as a safety measure.

## Receiving a call

An incoming call is announced by a ring and a superimposed display in the screen.

Press **SRC/TEL**.

or

 select "**YES**" to accept the call,

or

 select "**NO**" to reject the call.

 Pressing and holding the back button,

or

 on **SRC/TEL** also rejects an incoming call.

\* Depending on the compatibility of the telephone.

## Managing calls

### Hang up



In the contextual menu, select "**Hang up**" to end the call.

**SRC / TEL**

Pressing and holding on **SRC/TEL** also ends the call.

### Secret - Mute

(so that the caller cannot hear)

In the contextual menu:



Select "**Micro OFF**" to switch off the microphone.



Select "**Micro OFF**" to switch the microphone on again.

### Combined mode

(to leave the vehicle without ending the call)

From the contextual menu:



Select "**Combined mode**" to transfer the call to the telephone.



Select "**Combined mode**" to transfer the call to the vehicle.

**i** In certain cases, the combined mode has to be activated from the telephone. The Bluetooth connection will be restored automatically if the ignition has been switched off, then on again (depending on the compatibility of the telephone).

## Audio settings



Press **🎵** to display the audio settings menu.

Press **🎵** to go to the next setting.

The settings available are:

- AMBIANCE: BASS, TREBLE and LOUDNESS.
- BALANCE (left/right balance), FADER (front/rear balance)
- SOUND DIST. (driver or passenger).
- AUTO VOLUME.

**i** The distribution, or spatialisation of sound, is an audio process which allows the sound quality to be improved according to the setting chosen, corresponding to the position of the listeners in the vehicle.

**i** The AMBIANCE, TREBLE and BASS audio settings are different and independent for each sound source.



# Configuration

## Display and language settings

### MENU

Press the **MENU** button.



Select "**Config.**".



Select "**Displaying**" to activate or deactivate scrolling text.



Select "**Language**" to modify the display language.



Select "**Version**" for information on the software.



Select "**System**" when you want to install an update. Information can be obtained from a PEUGEOT dealer.



Select "**Unit**" to modify the units for temperature (Celsius, Fahrenheit).



# Screen menu map(s)

## MENU

### 1 Radio

- 2 TA
- 2 RDS
- 2 TXT
- 2 Write freq.

### 1 Media

- 2 Normal
- 2 Random
- 2 Random all
- 2 Repeat
- 2 TA

### 1 Telephone

- 2 Call
- 3 Directory
- 3 Calls list
- 4 Missed calls
- 4 Dialed calls
- 4 Answered calls

### 2 Phone status

### 1 Bluetooth

### 2 BT management

### 2 Search

### 1 Config.

- 2 Displaying
- 3 Scrolling text

### 2 Language

- 3 Deutsch
- 3 English
- 3 Español
- 3 Français
- 3 Italiano
- 3 Nederlands
- 3 Português
- 3 Português-Brasil
- 3 Русский
- 3 Türkçe

### 2 Version

### 2 System

- 2 Unit
- 3 Celsius
- 3 Fahrenheit

## Frequently asked questions

The following tables contain answers to the most frequently asked questions.

QUESTION	ANSWER	SOLUTION
<p>There is a difference in sound quality between the different audio sources (radio, CD...).</p>	<p>For optimum sound quality, the audio settings (volume, bass, treble, ambience, loudness) can be adapted to the different sound sources, which may result in audible differences when changing source (radio, CD...).</p>	<p>Check that the audio settings (volume, bass, treble, ambience, loudness) are adapted to the sources listened to. It is advisable to adjust audio settings (bass, treble, Front-Rear balance, Left-Right balance) to the middle position, select the musical ambience and set the loudness correction to the "Active" position in CD mode or to the "Inactive" position in radio mode.</p>
<p>When changing the settings for treble and bass, the ambience setting is deselected. When changing the ambience setting, treble and bass are reset to zero.</p>	<p>Choosing an ambience imposes settings for treble and bass. Modifying one without the other is only possible with a personalised ambience.</p>	<p>Modify the treble and bass settings or the ambience setting to obtain the desired sound quality.</p>
<p>When changing the balance setting, distribution is deselected.</p>	<p>Choosing the "driver" distribution setting imposes a balance setting.</p>	<p>Modify the balance setting or the distribution setting to obtain the desired sound quality.</p>



QUESTION	ANSWER	SOLUTION
The quality of reception of the radio station listened to gradually deteriorates or the stored stations do not function (no sound, 87.5 MHz is displayed...).	The vehicle is too far from the transmitter used by the station listened to or there is no transmitter in the geographical area through which the vehicle is travelling.	Activate the RDS function to enable the system to check whether there is a more powerful transmitter in the geographical area.
	The environment (hills, buildings, tunnels, basement car parks...) block reception, including in RDS mode.	This phenomenon is normal and does not indicate a failure of the audio equipment.
	The aerial is absent or has been damaged (for example when going through a car wash or into an underground car park).	Have the aerial checked by a PEUGEOT dealer.
Sound cut-outs of 1 to 2 seconds in radio mode.	During this brief sound cut-out, the RDS searches for any frequency permitting better reception of the station.	Deactivate the RDS function if the phenomenon is too frequent and always on the same route.
Traffic announcement TA is displayed. I do not receive any traffic information.	The radio station does not broadcast traffic information.	Tune to a radio station which broadcasts traffic information.
The stored stations are not found (no sound, 87.5 MHz is displayed...).	An incorrect waveband is selected.	Press the SRC/TEL button to return to the waveband (FM1 or FM2) on which the stations are stored.

QUESTION	ANSWER	SOLUTION
The CD is ejected automatically or is not played by the player.	The CD is inserted upside down, is unplayable, does not contain any audio data or contains an audio format which the player cannot play. The CD is protected by an anti-pirating protection system which is not recognised by the audio equipment.	<ul style="list-style-type: none"> <li>- Check that the CD is inserted in the player the right way up.</li> <li>- Check the condition of the CD: the CD cannot be played if it is too damaged.</li> <li>- Check the content in the case of a recorded CD: consult the advice in the "Audio" section.</li> <li>- The audio equipment's CD player does not play DVDs.</li> <li>- Due to their quality level, certain writeable CDs will not be played by the audio system.</li> </ul>
The CD player sound is poor.	The CD used is scratched or of poor quality.	Insert good quality CDs and store them in suitable conditions.
	The audio settings (bass, treble, ambience) are unsuitable.	Set the treble or bass level to 0, without selecting an ambience.
The Bluetooth connection is cut.	The battery of the peripheral may not be sufficiently charged.	Recharge the battery of the peripheral device.
The message "USB device error" is displayed on the screen.	The USB memory stick is not recognised.	Use only USB memory sticks formatted to FAT 32 (28-bit file allocation table).
A telephone connects automatically, disconnecting another telephone.	Automatic connection overrides manual connection.	Modify the telephone settings to remove automatic connection.

QUESTION	ANSWER	SOLUTION
An iPod is not recognised when connecting to the USB port.	The iPod is of a generation that is not compatible with the USB connection.	
The hard disk or device is not recognised when connecting to the USB port.	Some hard disks and devices need a power supply greater than is provided by the audio system.	Connect the device to the 230 V socket, the 12 V socket or an external power supply. <b>Caution:</b> ensure that the device does not transmit a voltage greater than 5 V (risk of destruction of the system).
When streaming, the sound cuts momentarily.	Some telephones prioritise connection of the "hands-free" profile.	Delete the "hands-free" connection profile to improve streaming.
In "Random all" play, not all of the tracks are played.	In "Random all" play, the system can only take into account up to 999 tracks.	
With the engine off, the audio system switches off after a few minutes of use.	When the engine is switched off, the audio system operating time depends on the battery charge. The switch-off is normal: the audio system switches to economy mode and switches off to prevent discharging the vehicle's battery.	Start the vehicle's engine to increase the battery charge.
The message "the audio system is overheated" appears on the display.	In order to protect the installation if the surrounding temperature is too high, the audio system switches to an automatic thermal protection mode leading to a reduction of the volume or stopping of the playing of the CD.	Switch the audio system off for a few minutes to allow the system to cool.

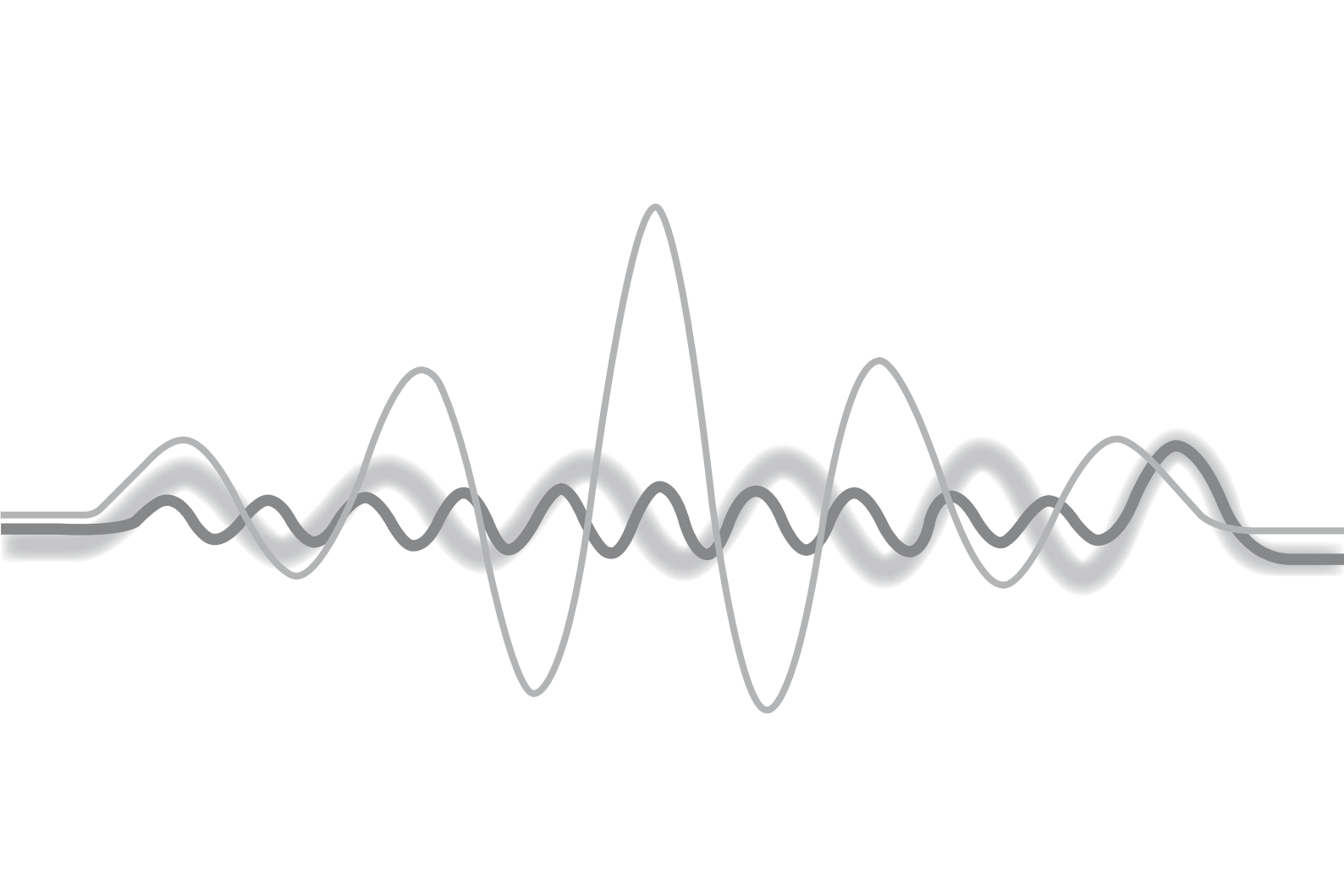

# Audio system

10



	Contents
First steps	316
Steering mounted controls	317
Radio	318
Media	320
Audio settings	322
Screen menu map(s)	323
Frequently asked questions	324

! As a safety measure, the driver must only carry out operations which require prolonged attention while the vehicle is stationary. When the engine is switched off and to prevent discharging of the battery, the system switches off after activation of economy mode.

# First steps



On / Off, volume adjustment.

SRC/BAND

Selection of source:  
FM1, FM2, AM, CD, AUX.



Adjust audio settings:  
sound ambience, treble, bass,  
loudness, left/right balance,  
automatic volume.



Automatic search for a lower/higher  
radio frequency.  
Select the next CD track.  
Navigation in a list.  
Press and hold: fast forward or back.

**LIST**

Display the list of stations received,  
the CD/MP3 tracks or folders.  
Press and hold: update the list of  
stations received.



Manual search step by step for a  
higher radio frequency.  
Select the next MP3 track.  
Navigation in a list.



Manual search step by step for a  
lower radio frequency.  
Select the previous MP3 track.  
Navigation in a list.



Abandon the current operation.  
Go up one level (menu or folder).



Automatic search step by step for a  
higher radio frequency.  
Select the next CD track.  
Navigation in a list.  
Press and hold: fast forward.

**MENU**

Open the main menu.



Select a preset radio station.  
Radio, press and hold: preset a radio  
station.



Eject CD.

# Steering mounted controls



Radio: select the previous / next preset station.  
Select the previous / next item in a menu.



Radio: automatic search for a lower frequency.  
CD / MP3: select the previous track.  
CD: press and hold: fast back.



Radio: automatic search for a higher frequency.  
CD / MP3: select the next track.  
CD: press and hold: fast forward.



Volume up.



Volume down.



Change audio source.  
Confirm a selection.



Mute on: cut the sound by simultaneously pressing the volume up and down buttons.  
Mute off: press one of the volume buttons.

# Radio

## Presetting a station

 Press the **SRC/BAND** button repeatedly to select the FM1, FM2 or AM waveband.

 Press and hold a button to preset the station being listened to. The name of the station is displayed and an audible signal confirms that it has been preset.

**i** The external environment (hills, buildings, tunnels, basement car parks) may block reception, including in RDS mode. This is a normal effect of the way in which radio waves are transmitted and does not indicate any failure of the audio equipment.

## Selecting a station

 Press a button to listen to the corresponding preset station.

## Managing the list

**LIST** Press **LIST** to display the list of stations received, in alphabetical order.

 Select the desired radio station by pressing one of the buttons.

**OK** Confirm with **OK**.

 Briefly press one of the buttons to change to the next or previous letter.

**LIST** Press and hold on **LIST** to construct or update the list of stations; the sound is interrupted temporarily.

## RDS

**i** RDS, if displayed, enables you to continue listening to the same station by automatic retuning to alternative frequencies. However, in certain conditions, coverage by an RDS station may not be assured throughout the country as radio stations do not cover 100 % of the territory. This explains the loss of reception of the station during a journey.

**MENU** Press **MENU**.

 Select **"Radio"**.

**OK** Confirm with **OK**.

 Select **"RDS"**.

**OK** Confirm with **OK**.





Select "**On**" or "**Off**" to switch RDS on or off.

**OK**

Confirm with **OK**.

## Receiving TA messages

**i** The TA (Traffic Announcement) function gives priority to TA alert messages. To operate, this function needs good reception of a radio station transmitting this type of message. When a traffic report is transmitted, the current audio source (Radio, CD, ...) is interrupted automatically to play the TA message. Normal playback of the audio source resumes at the end of the transmission of the message.



Select "**On**" or "**Off**" to switch on or off the reception of traffic announcements.

**OK**

Confirm with **OK**.

**MENU**

Press **MENU**.



Select "**Radio**".

**OK**

Confirm with **OK**.



Select "**Traffic TA**".

**OK**

Confirm with **OK**.

## Display RADIO TEXT

**i** Radio Text is information transmitted by the radio station on the station or on the song being played.

**MENU** Press **MENU**.

**▲**  
**▼** Select "**Radio**".

**OK** Confirm with **OK**.

**▲**  
**▼** Select "**INFO TEXT**".

**OK** Confirm with **OK**.

**◀▶** Select "**On**" or "**Off**" to switch radio text on or off.

**OK** Confirm with **OK**.

## Media

### Auxiliary socket (AUX)

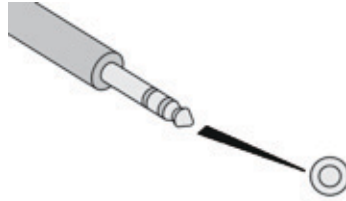

Connect the portable device (MP3 player...) to the auxiliary Jack socket using an audio cable (not supplied).

**SRC/BAND** Press the **SRC/BAND** button repeatedly and select "**AUX**".

First adjust the volume on your portable device (to a high level). Then adjust the volume on your audio system. Control is from the portable device.

### CD player

Insert a CD into the player, play starts automatically.

Insert an MP3 compilation in the CD player. The audio system searches for audio tracks, which can take from a few to several dozen seconds before play starts.

**SRC/BAND** Press the **SRC/BAND** button repeatedly to select "**CD**".

**◀▶** Press one of these buttons to select a track in the list.

**▲**  
**▼** Press one of these buttons to select the previous or next folder according to the category chosen.

**◀▶** Press and hold one of these buttons for fast forward or back.



## Playing a compilation

**LIST**

Press **LIST** to display the folder structure for the compilation.



Select a line in the list.

**OK**

Confirm with "**OK**".



Jump a page.



Select a folder / Playlist.

**OK**

Start play of the chosen track.



Go up one level.

Go back to the first level to select the track classification:

- By **Folders**: all folders containing audio files recognised on the peripheral device, in alphabetical order, ignoring the folder structure.
- By **Playlist**: depending on the playlists saved.



The play modes available are:

- Normal: the tracks are played in order, depending on the classification of the selected files.
- Random: the tracks in an album or folder are played in a random order.
- Random all: all of the tracks saved in the media are played in random order.
- Repeat: the tracks played are only those from the current album or folder.

## Play mode

**MENU**

Press **MENU**.



Select "**Media**".

**OK**

Confirm with **OK**.



Select the desired play mode.

**OK**

Confirm with **OK** to save the changes.

## Information and advice

The audio system can only play files with ".mp3", ".wma" or ".wav" extensions.

It is advisable to restrict file names to 20 characters without using special characters (e.g. " ? ; ù) to avoid any playing or displaying problems.

In order to be able to play a recorded CDR or CDRW, when recording it is preferable to select standards ISO 9660 level 1.2 or Joliet.

If the disc is recorded in another format, it may not be played correctly.

It is recommended that the same recording standard is always used for a given disc, with as low a speed as possible (4x maximum) for optimum sound quality.

In the particular case of a multi-session CD, the Joliet standard is recommended.

Playlists accepted are types .m3u and .pls. The system can recognise up to 5 000 files in 500 folders on 8 levels.

On a given disc, the CD player can read up to 255 MP3 files spread over 8 levels. However, it is advisable to keep to a limit of two levels to reduce the access time before the CD is played.

The folder structure is not observed during playback.

## Audio settings



Press  to display the audio settings menu.

The settings available are:

- AMBIANCE,
- BASS,
- TREBLE,
- LOUDNESS,
- BALANCE (L/R),
- AUTO VOLUME.



Select the settings to adjust.



Confirm with **OK**.



Adjust the setting.



Confirm with **OK**.



The AMBIANCE, TREBLE and BASS settings are different and independent for each sound source.



# Screen menu map(s)

## MENU

- 1 **Radio**
- 2 Traffic
- 2 RDS
- 2 TEXT INFO
  
- 1 **Media**
- 2 Play
- 3 Normal
- 3 Random
- 3 Random all
- 3 Repeat
- 2 TEXT INFO

- 1 **Displaying**
- 2 SCROLLING
  
- 1 **Unit**
- 2 Celsius
- 2 Fahrenheit
  
- 1 **Language**

## Frequently asked questions

The following tables contain answers to the most frequently asked questions.

QUESTION	ANSWER	SOLUTION
<p>There is a difference in sound quality between the different audio sources (radio, CD...).</p>	<p>For optimum sound quality, the audio settings (Volume, Bass, Treble, Ambiance, Loudness) can be adapted to the different sound sources, which may result in audible differences when changing source (radio, CD...).</p>	<p>Check that the audio settings (Volume, Bass, Treble, Ambiance, Loudness) are adapted to the sources listened to. It is advisable to set the AUDIO functions (Bass, Treble, Front-Rear Fader, Left-Right Balance) to the middle position, select the musical ambience "None" and set the loudness correction to the "Active" position in CD mode or to the "Inactive" position in radio mode.</p>
<p>When changing the settings for treble and bass, the ambience setting is deselected. When changing the ambience setting, treble and bass are reset to zero.</p>	<p>Choosing an ambience imposes settings for treble and bass. Modifying one without the other is not possible.</p>	<p>Modify the treble and bass settings or the ambience setting to obtain the desired sound quality.</p>

QUESTION	ANSWER	SOLUTION
The quality of reception of the radio station listened to gradually deteriorates or the stored stations do not function (no sound, 87.5 MHz is displayed...).	The vehicle is too far from the transmitter used by the station listened to or there is no transmitter in the geographical area through which the vehicle is travelling.	Switch on the RDS function to enable the system to check whether there is a more powerful transmitter in the geographical area.
	The environment (hills, buildings, tunnels, basement car parks...) block reception, including in RDS mode.	This phenomenon is normal and does not indicate a failure of the audio equipment.
	The aerial is absent or has been damaged (for example when going through a car wash or into an underground car park).	Have the aerial checked by a PEUGEOT dealer.
Sound cut-outs of 1 to 2 seconds in radio mode.	During this brief sound cut-out, the RDS searches for any frequency permitting better reception of the station.	Switch off the RDS function if the phenomenon is too frequent and always on the same route.
The traffic announcement (TA) is displayed. I do not receive any traffic information.	The radio station does not broadcast traffic information.	Tune to a radio station which broadcasts traffic information.
The stored stations are not found (no sound, 87.5 MHz is displayed...).	An incorrect waveband is selected.	Press the SRC button to return to the waveband (AM, FM1, FM2) on which the stations are stored.

QUESTION	ANSWER	SOLUTION
The CD is ejected automatically or is not played by the player.	The CD is inserted upside down, is unplayable, does not contain any audio data or contains an audio format which the player cannot play. The CD is protected by an anti-pirating protection system which is not recognised by the audio equipment.	<ul style="list-style-type: none"> <li>- Check that the CD is inserted in the player the right way up.</li> <li>- Check the condition of the CD: the CD cannot be played if it is too damaged.</li> <li>- Check the content in the case of a recorded CD: consult the advice in the "Audio" section.</li> <li>- The audio system's CD player does not play DVDs.</li> <li>- Due to their quality level, certain writeable CDs will not be played by the audio system.</li> </ul>
The CD player sound is poor.	The CD used is scratched or of poor quality.	Insert good quality CDs and store them in suitable conditions.
	The audio settings (bass, treble, ambiance) are unsuitable.	Set the treble or bass level to 0, without selecting an ambiance.
In "Random all" play, not all of the tracks are played.	In "Random all" play, the system can only take into account up to 999 tracks.	
With the engine off, the audio system switches off after a few minutes of use.	When the engine is switched off, the audio system operating time depends on the battery charge. The switch-off is normal: the audio system switches to economy mode and switches off to prevent discharging the vehicle's battery.	Start the vehicle's engine to increase the battery charge.
The message "the audio system is overheated" appears on the display.	In order to protect the installation if the surrounding temperature is too high, the audio system switches to an automatic thermal protection mode leading to a reduction of the volume or stopping of the playing of the CD.	Switch the audio system off for a few minutes to allow the system to cool.



**A**

Accessories .....	162
Access to rear seats .....	36
Active City Brake.....	141
AdBlue® .....	20, 174
Adjusting headlamps .....	85
Adjusting head restraints .....	50
Adjusting seats.....	49, 51
Adjusting the air distribution .....	60, 62, 63
Adjusting the air flow.....	60, 62, 63
Adjusting the date .....	33
Adjusting the seat belt height .....	93
Adjusting the temperature .....	59, 61, 63
Adjusting the time .....	33
Advice on driving .....	117, 160
Airbags .....	23, 96
Airbags, curtain.....	98, 99
Airbags, front.....	96, 99
Airbags, lateral.....	98, 99
Air conditioning, digital .....	63
Air conditioning, manual .....	61
Air intake .....	56, 60, 62, 65, 63
Air vents .....	56
Alarm .....	41
Anti-lock braking system (ABS).....	90
Anti-theft .....	45, 118
Armrest, front.....	52
Assistance call .....	223
Assistance, emergency braking .....	90
Audio streaming (Bluetooth).....	254, 256, 303
Audio system.....	295, 315
Auxiliary .....	72, 254, 300, 320

**B**

Battery.....	208-211
Battery, charging.....	210
Battery, remote control .....	44, 45
Blind, panoramic roof.....	70
BlueHDI.....	20, 174, 214
Bluetooth (telephone).....	282, 304
Bonnet.....	167
Boot.....	43
Brake discs/pads.....	173
Brake lamps .....	199, 200
Brake warning lamp .....	18
Braking assistance system .....	90
Braking, automatic emergency.....	141
Bulbs (changing) .....	195

**C**

Cable, audio .....	74, 254, 300, 320
Capacity, fuel tank .....	154
CarPlay connection.....	275, 276
CD .....	254, 301
Central locking .....	37
Changing a bulb .....	195
Changing a fuse.....	202
Changing a wheel .....	188
Changing a wiper blade .....	164
Changing the remote control battery.....	44
Checking the engine oil level.....	171
Checking the levels.....	25, 89, 168, 172, 180
Checking tyre pressures (using the kit) .....	186

Checks .....	121, 168, 169, 173
Child lock.....	114
Children (safety).....	95, 100-114
Child seats .....	100, 113
Child seats, conventional.....	106
Child seats, ISOFIX .....	110
Closing the boot .....	43
Closing the doors.....	37
Connected services.....	266
Connection, Bluetooth .....	282, 304
Connection, MirrorLink™.....	270
Connection, Wi-Fi network .....	268
Control, electric windows.....	46
Control, emergency boot release.....	43
Control, heated seats.....	52
Controls, at steering.....	228, 297, 319
Control stalk, lighting .....	77, 80
Control stalk, wipers .....	87
Courtesy lamp.....	68
Cruise control.....	136, 139
Cup holder.....	71

**D**

DAB (Digital Audio Broadcasting) - Digital radio.....	252
Date (setting).....	33
Daytime running lamps.....	83, 195-197
Deactivating the passenger airbag.....	97, 102

Deadlocking .....39  
 Demisting/defrosting ..... 58, 64, 66  
 Dials and gauges ..... 11  
 Diesel ..... 157  
 Dimensions .....218  
 Dipstick..... 170, 171  
 Direction  
   indicators ..... 80, 84, 195, 196, 199, 200  
 Display screen,  
   instrument panel ..... 12, 129  
 Driving abroad.....85  
 Driving economically..... 115  
 Dynamic stability control  
   (DSC) .....19, 90, 91

## E

Eco-driving ..... 115  
 Electronic brake force  
   distribution (EBFD) .....90  
 Emergency braking  
   assistance (EBA) .....90  
 Emergency call .....222  
 Emergency warning lamps .....90, 182  
 Emissions control system, SCR ..... 21, 174  
 Engine compartment .....168, 169  
 Engine, Diesel ..... 15, 157, 169, 214  
 Engine, petrol ..... 157, 168  
 Environment ..... 44, 115, 151, 172, 178, 208

## F

Filling the fuel tank ..... 154, 156, 157  
 Filter, air ..... 173  
 Filter, oil ..... 173  
 Filter, particle ..... 155  
 Filter, passenger compartment..... 57, 173  
 Fitting a wheel .....193  
 Fitting roof bars .....165  
 Fittings, boot ..... 73  
 Fittings, interior ..... 71  
 Flap, fuel filler..... 154, 156  
 Flashing indicators .....84, 196  
 Foglamp, rear .....81, 199, 200  
 Foglamps, front ..... 81, 86, 198  
 Frequency (radio) .....250, 298, 318  
 Fuel ..... 157  
 Fuel consumption..... 115  
 Fuel tank.....154, 156  
 Fusebox, dashboard ..... 204, 206  
 Fusebox, engine compartment .....207  
 Fuses.....202

## G

Gauge, fuel..... 11, 154  
 Gearbox, automatic .....126, 208  
 Gearbox, electronic ..... 123, 131  
 Gearbox, manual ..... 122, 131  
 Gear lever, manual gearbox ..... 122  
 Gear shift indicator ..... 129  
 Glove box ..... 71  
 Guide-me-home.....36, 79, 80

## H

Hazard warning lamps .....90, 182  
 Headlamps, automatic illumination .....79  
 Headlamps ..... 77, 195-197  
 Head restraints, front .....50  
 Head restraints, rear .....54, 55  
 Heating ..... 59, 61, 63  
 Hill start assist..... 130

## I

Identification, vehicle .....220  
 Ignition ..... 120  
 Immobiliser, electronic ..... 45, 118  
 Indicator, coolant temperature .....25  
 Indicator, engine oil level ..... 170, 171  
 Indicator lamps, operation ..... 14  
 Indicators, direction ..... 84, 196, 199, 200  
 Inflating tyres ..... 115, 220  
 Inflating tyres and accessories  
   (using the kit) ..... 186  
 Input, auxiliary..... 74, 254, 300, 320  
 Instruments and controls ..... 11, 48  
 Internet browser .....267  
 Isofix mountings ..... 109

**J**

Jack.....	188
Jukebox.....	257
Jump starting.....	209

**K**

Key with remote control.....	35, 45, 118
Kit, hands-free.....	282, 304
Kit, temporary puncture repair.....	183

**L**

Labels, identification.....	220
Lamps, parking.....	80
Level, AdBlue® additive.....	174
Level, brake fluid.....	170
Level, Diesel additive.....	155
Level, engine coolant.....	25
Level, engine oil.....	170, 171
Levels and checks.....	25, 89, 168-173, 180
Level, screenwash fluid.....	89
Light-emitting diodes - LEDs.....	200

Lighting, cornering.....	86
Lighting dimmer.....	34
Lighting, guide-me home.....	36, 79, 80
Lighting, interior.....	68, 69
Lighting, mood.....	69
Loading.....	115, 165
Load reduction mode.....	161
Locating your vehicle.....	36
Low fuel level.....	22, 154

**M**

Maintenance, routine.....	115
Map reading lamps.....	68
Markings, identification.....	220
Mat.....	71
Menu.....	230, 323
Menus (Touch screen).....	225, 229
Mirror, rear view.....	76
Mirrors, door.....	75
Misfuel prevention.....	156
Mountings, Isofix.....	109
MP3 CD.....	254, 301

**N**

Navigation.....	230
Number plate lamps.....	201

**O**

Opening the bonnet.....	167
Opening the boot.....	43
Opening the doors.....	35
Opening the fuel filler flap.....	154
Opening the panoramic roof blind.....	70

**P**

Pads, brake.....	121, 173
Paint colour code.....	220
Paint, matt.....	181
Parcel shelf, rear.....	74
Park Assist.....	147
Parking brake.....	121
Petrol.....	157
PEUGEOT Connect Assistance.....	223
PEUGEOT Connect Packs.....	223
PEUGEOT Connect SOS.....	222
Plates, identification.....	220
Player, Apple®.....	256
Player, MP3 CD.....	254, 301

Player, USB .....	254
Port, USB .....	72, 254, 300
Pre-heater, Diesel .....	15
Pressures, tyres .....	220
Pre-tensioning seat belts .....	95
Priming the fuel system .....	214
Protecting children .....	95, 100-114
Puncture .....	183

## R

Radio .....	250, 298, 318
Radio, digital (Digital Audio Broadcasting - DAB) .....	252
Range, AdBlue .....	176
RDS .....	251, 299, 318
Rear screen, demisting .....	67
Recharging the battery .....	210
Recirculation, air .....	60, 62, 65
Reduction of electrical load .....	161
Regeneration of the particle filter .....	155
Reinitialisation of the under-inflation detection system .....	153
Reinitialising the remote control .....	44
Reminder, key in ignition .....	120
Reminder, lighting on .....	82
Remote control .....	35, 45
Removing a wheel .....	191
Removing the mat .....	71
Replacing bulbs .....	195
Replacing fuses .....	202

Replacing the air filter .....	173
Replacing the oil filter .....	173
Replacing the passenger compartment filter .....	57, 173
Reservoir, screenwash .....	89
Resetting the service indicator .....	28
Reversing camera .....	146
Reversing lamps .....	199, 200
Risk areas (update) .....	241
Roof bars .....	165
Roof, panoramic .....	70
Running out of fuel (Diesel) .....	214

## S

Safety, children .....	95, 100-114
Screen, instrument panel .....	30, 31
Screen menu map .....	230, 244, 258, 266, 272, 276, 278, 309, 323
Screenwash .....	89
Screenwash, rear .....	88
SCR (Selective Catalytic Reduction) .....	174
Seat belts .....	93-95, 106
Seats, front .....	36, 49, 51
Seats, heated .....	52
Seats, rear .....	53, 54
Serial number, vehicle .....	220
Service indicator .....	26
Servicing .....	115

Settings (Menus) .....	258
Sidelamps .....	77, 80, 83, 195-197, 199, 200
Side repeater .....	199
Snow chains .....	158
Socket, 12 V accessory .....	72
Sockets, audio .....	72, 254, 300, 320
Speed limiter .....	134, 139
Starting the engine .....	118
Starting the vehicle .....	118, 119, 123, 126
Starting using another battery .....	209
Station, radio .....	250, 298, 318
Stay, bonnet .....	167
Steering mounted controls, audio .....	228, 297, 317
Stopping the vehicle .....	118
Stop & Start .....	16, 66, 131, 147, 154, 167, 208, 211
Storage .....	52, 71
Stowing rings .....	73
Switching off the engine .....	120
Synchronising the remote control .....	44

## T

Tables of fuses .....	202
Tank, AdBlue® additive .....	174
Tank, fuel .....	154, 156
Telephone .....	278, 304
Temperature, coolant .....	25

---

**V**

Third brake lamp .....	201
Three flashes (direction indicators) .....	84
Time (setting) .....	33
TMC (Traffic info) .....	242
Tools .....	188, 202, 212
Touch screen .....	29, 31, 153
Touch screen (Menus) .....	225, 229
Towbar .....	159, 160
Towing another vehicle .....	213
Traction control (ASR) .....	19, 90
Traffic information (TA) .....	243, 299
Traffic information (TMC) .....	242
Trailer .....	159, 160
Trajectory control systems .....	90
Triangle, warning .....	182
Trip computer .....	30, 31
Tyres .....	115, 218
Tyre under-inflation detection .....	151

Ventilation .....	56-58, 61, 115
Voice recognition .....	271, 275

---

**W**

---

**U**

Under-inflation (detection) .....	151
Unlocking .....	35
Unlocking the boot .....	43
Updating risk areas .....	241
Updating the date .....	33
Updating the time .....	33
USB .....	72, 254, 309

Warning and indicator lamps .....	14
Warning lamp, braking system .....	18
Warning lamp, Diesel engine pre-heater .....	15
Warning lamp, SCR emissions control system .....	21
Wheel, spare .....	188
Window controls .....	46
Wiper blades (changing) .....	164
Wiper, rear .....	88
Wipers .....	16, 87
Wipers, automatic rain sensitive .....	87













This handbook describes all of the equipment available in the whole range.

Your vehicle will be fitted with some of this equipment described in this document, depending on its trim level, version and the specification for the country in which it is sold.

The descriptions and illustrations are given without any obligation. Automobiles PEUGEOT reserves the right to modify the technical specifications, equipment and accessories without having to update this edition of the handbook.

This document is an integral part of your vehicle. It should be passed on to the new user in the event of sale or transfer. In addition, there are labels present in your vehicle to warn you of the need for certain precautions to take for your safety; don't remove them, they will be useful again for a new owner.

Automobiles PEUGEOT declares, by application of the provisions of the European regulation (Directive 2000/53) relating to End of Life Vehicles, that it achieves the objectives set by this regulation and that recycled materials are used in the manufacture of the products that it sells.

Reproduction or translation of all or part of this document is prohibited without written authorisation from Automobiles PEUGEOT.

For any work on your vehicle, use a qualified workshop that has the technical information, competence and equipment required, which a PEUGEOT dealer is able to provide.

### **We draw your attention to the following points:**

- The fitting of electrical equipment or accessories not listed by PEUGEOT may cause faults and failures with the electrical system of your vehicle. Contact a PEUGEOT dealer for information on the range of recommended accessories.
- As a safety measure, access to the diagnostic socket, used for the vehicle's electronic systems, is reserved strictly for PEUGEOT dealers or qualified workshops, equipped with the special tools required (risk of malfunctions of the vehicle's electronic systems that could cause breakdowns or serious accidents). The manufacturer cannot be held responsible if this advice is not followed.
- Any modification or adaptation not intended or authorised by Automobiles PEUGEOT or carried out without meeting the technical requirements defined by the manufacturer would lead to the suspension of the legal and contractual warranties.

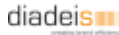

**PEUGEOT**





Automobiles PEUGEOT - Siège Social : 75, avenue de la Grande-Armée 75016 PARIS  
Tél. 33 (0)1 40 66 55 11 - Fax 33 (0)1 40 66 54 14

Adresse postale : Automobiles PEUGEOT B.P. 01 75761 PARIS cedex 16 - Adresse Internet : <http://www.peugeot.com>

Société Anonyme au capital de 172 771 770 Euros - R.C.S. PARIS B 552 144 503. SIRET 552 144 503 00018. APE 341 Z

Printed in the EU  
Anglais  
01-16



Warning / indicator lamp		State	Cause	Action / Observations
	<b>Low fuel level</b>	fixed with the needle in the red zone.	There remains approximately <b>5 litres</b> of fuel in the tank. At this point, you begin to use the fuel reserve.	Refuel as soon as possible to avoid running out of fuel. This warning lamp will come on every time the ignition is switched on, until a sufficient addition of fuel is made.
		flashing with the needle in the red zone.	There remains very little fuel in the tank.	Fuel tank capacity: approximately <b>50 litres (45 litres</b> for the BlueHDi Diesel engine). Never continue to drive until you run out of fuel, as this could damage the emission control and injection systems.
	<b>Engine oil pressure</b>	fixed.	There is a fault with the engine lubrication system.	You must stop as soon it is safe to do so. Park, switch off the ignition and contact a PEUGEOT dealer or a qualified workshop.
	<b>Battery charge*</b>	fixed.	The battery charging circuit has a fault (dirty or loose terminals, slack or cut alternator belt, ...).	The warning lamp should go off when the engine is started. If it does not go off, contact a PEUGEOT dealer or a qualified workshop.
	<b>Under-inflation</b>	fixed.	The pressure in one or more wheels is too low.	Check the pressure of the tyres as soon as possible. This check should preferably be carried out when the tyres are cold.
		flashing then fixed, accompanied by the Service warning lamp.	The tyre pressure monitoring system has a fault or no sensor is detected on one of the wheels.	Under-inflation detection is not assured. Have the system checked by a PEUGEOT dealer or a qualified workshop.
				

\* Depending on the country of sale.

## Fuel tank

Fuel tank capacity: approximately **50 litres** (**45 litres** for the BlueHDi Diesel engine).

### Low fuel level



When the low fuel level is reached this warning lamp comes on in the instrument panel. There remains **approximately 5 litres** of fuel in the tank. When the warning lamp flashes, there is **very little fuel left**.

You must refuel as soon as possible to avoid running out of fuel.

For more information on **Running out of fuel (Diesel)**, refer to the corresponding section.

**i** The key cannot be removed from the lock until the cap is refitted. Removing the filler cap may cause an inrush of air. This vacuum is perfectly normal and results from the sealing of the system.

**!** With Stop & Start, never refuel with the system in STOP mode; you must switch off the ignition with the key.

### Refuelling

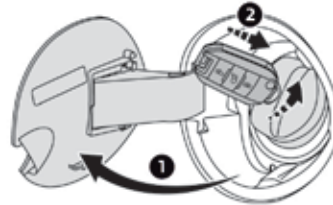

1. Open the filler flap.
2. Remove the filler cap.
3. Hook the filler cap.

A self-adhesive label on the inner face of the filler flap reminds you of the type of fuel to use depending on your engine.

Additions of fuel must be of at least 5 litres to be registered by the fuel gauge.

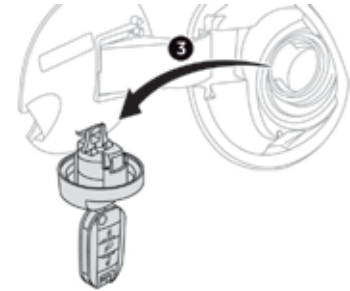

To fill the tank safely:

- ☞ **the engine must be switched off,**
- ☞ open the fuel filler flap 1,
- ☞ insert the key in the cap 2, then turn it to the left,
- ☞ remove the cap and hook it onto the clip located on the inside of the flap 3,
- ☞ fill the tank, **but do not continue after the 3rd cut-off of the pump**; this could cause malfunctions.

When you have filled the tank:

- ☞ put the cap back in place,
- ☞ turn the key to the right, then remove it from the cap,
- ☞ close the flap.

**!** If you have put in the wrong fuel for the engine of your vehicle, you must have the fuel tank drained and filled with the correct fuel before starting the engine.

## Fuel supply cut-off

Your vehicle is fitted with a safety system that cuts off the supply of fuel in the event of an impact.

## Diesel Particle filter

### SERVICE

The start of saturation of the particle filter is indicated by the fixed illumination of this warning lamp accompanied by a warning message in the screen (if a display screen is fitted).

As soon as the traffic conditions permit, regenerate the filter by driving at a speed of at least 40 mph (60 km/h) until the warning lamp goes off.

If the warning lamp stays on, this indicates a low additive level.

**i** On a new vehicle, the first particle filter regeneration operations may be accompanied by a "burnt" smell, which is normal.

Following prolonged operation of the vehicle at very low speed or at idle, you may, in exceptional circumstances, notice the emission of water vapour at the exhaust on acceleration. This does not affect the behaviour of the vehicle or the environment.

## Diesel additive

### SERVICE

A low additive level is indicated by illumination of the service warning lamp, accompanied by an audible warning and a message in the screen (if a display screen is fitted).

### Topping-up

This additive must be topped-up by a PEUGEOT dealer or a qualified workshop without delay.

# Emergency or assistance call

## Type 1

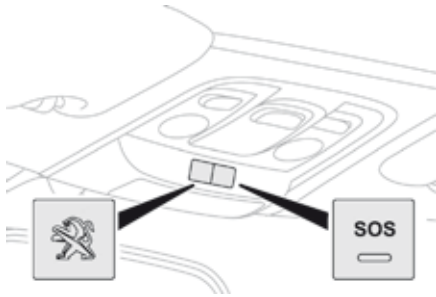

## PEUGEOT Connect SOS



In an emergency, press this button for more than 2 seconds. Flashing of the green indicator lamp and a voice message confirm that the call has been made to the "PEUGEOT Connect SOS"<sup>\*\*</sup> centre.

Pressing this button again immediately cancels the call.

The green indicator lamp goes off.

The green indicator lamp remains on (without flashing) when communication is established. It goes off at the end of the call.

PEUGEOT Connect SOS immediately locates your vehicle, makes contact with you in your language<sup>\*\*</sup> and - if necessary - organises sending of the appropriate emergency services<sup>\*\*</sup>. In countries where the service is not operational, or if the locating service has been expressly declined, the call is directed straight to the emergency services (112) without location.

**!** If an impact is detected by the airbag control unit, and independently of the deployment of any airbags, an emergency call is made automatically.

**i** If you benefit from the PEUGEOT Connect Packs offer with the SOS and assistance pack included, there are additional services available to you in your personal space, via the Internet website for your country.

\* Depending on the terms and conditions for the service, available from dealers, and technological and technical limits.

\*\* Depending on the geographic cover for "PEUGEOT Connect SOS", "PEUGEOT Connect Assistance" and the official national language selected by the owner of the vehicle.

The list of countries covered by PEUGEOT CONNECT services is available at dealers or on the website in your country.



## Operation of the system



When the ignition is switched on, the green indicator lamp comes on for 3 seconds indicating that the system is operating correctly.



If the orange indicator lamp flashes then goes off: the system has a fault.

If the orange indicator lamp is on fixed: the back-up battery should be replaced.

In both cases, the emergency and assistance calls service may not work.

Contact a qualified repairer as soon as possible.

**i** The fault with the system does not prevent the vehicle being driven.

## PEUGEOT Connect Assistance



Press this button for more than 2 seconds to request assistance if the vehicle breaks down. A voice message confirms that the call has been made\*\*.

Pressing this button again immediately cancels the request.

The cancellation is confirmed by a voice message.

## Geo-location



You can deactivate geo-location by simultaneously pressing the "PEUGEOT Connect SOS" and "PEUGEOT Connect Assistance" buttons, followed by a press on "PEUGEOT Connect Assistance" to confirm.

To reactivate geo-location, simultaneously press the "PEUGEOT Connect SOS" and "PEUGEOT Connect Assistance" buttons again, followed by a press on "PEUGEOT Connect Assistance" to confirm.

**i** If you purchased your vehicle outside the Brand's dealer network, we suggest that you have a dealer check and, if desired, modify the configuration of these services. In a multi-lingual country, configuration is possible in the official national language of your choice.

**i** For technical reasons, particularly to improve the quality of PEUGEOT CONNECT services to customers, the manufacturer reserves the right to carry out updates to the vehicle's on-board telematic system.

\*\* Depending on the geographic cover for "PEUGEOT Connect SOS", "PEUGEOT Connect Assistance" and the official national language selected by the owner of the vehicle.

The list of countries covered by PEUGEOT CONNECT services is available at dealers or on the website in your country.

# Emergency or assistance call

## Type 2

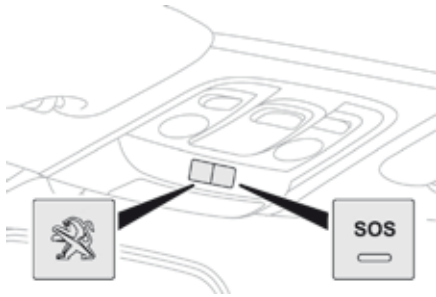

## PEUGEOT Connect SOS



In an emergency, press this button for more than 2 seconds. Flashing of the green LED and a voice message confirm that the call has been made to the "PEUGEOT Connect SOS" call centre\*.

Pressing this button again immediately cancels the request.  
The green LED goes off.

The green LED remains on (without flashing) when communication is established. It goes off at the end of the call.

"PEUGEOT Connect SOS" immediately locates your vehicle, starts communication with you in your language\*\*, and where necessary sends the appropriate public emergency services\*\*. In countries where the service is not available, or when the locating service has been expressly declined, the call is sent directly to the emergency services (112) without the vehicle location.

**!** If an impact is detected by the airbag control unit, and independently of the deployment of any airbags, an emergency call is made automatically.

**i** If you benefit from the PEUGEOT Connect Packs offer with the SOS and assistance pack included, there are additional services available to you in your personal space, via the Internet website for your country.

\* Subject to the general conditions for the service available from dealers and subject to technological and technical limitations.

\*\* Depending on the geographical cover of "PEUGEOT Connect SOS", "PEUGEOT Connect Assistance" and the official national language selected by the owner of the vehicle.

The list of countries covered and PEUGEOT CONNECT services is available from dealers or on the website in your country.

## Operation of the system



When the ignition is switched on, the green LED comes on for 3 seconds indicating that the system is operating correctly.

### For all countries except Russia, Belarus and Kazakhstan.



The red indicator lamp flashes then goes off: there is a system fault.

The red indicator lamp is on continuously: replace the back-up battery.

### For Russia, Belarus and Kazakhstan.



The red indicator lamp is on continuously: there is a system fault.

The red indicator lamp flashes: replace the back-up battery.

In either case, the emergency and assistance calls may not function.

Contact a qualified repairer as soon as possible.

**i** A fault with the system does not prevent the vehicle being driven.

## PEUGEOT Connect Assistance



Press this button for more than 2 seconds to request assistance if the vehicle breaks down. A voice message confirms that the call has been made\*\*.

Pressing this button again immediately cancels the request.

The cancellation is confirmed by a voice message.

## Geo-location



You can deactivate geo-location by simultaneously pressing the "PEUGEOT Connect SOS" and "PEUGEOT Connect Assistance" buttons, followed by a press on "PEUGEOT Connect Assistance" to confirm.

To reactivate geo-location, simultaneously press the "PEUGEOT Connect SOS" and "PEUGEOT Connect Assistance" buttons again, followed by a press on "PEUGEOT Connect Assistance" to confirm.

**i** If you purchased your vehicle outside the Brand's dealer network, we invite you to have a dealer check the configuration of these services and, if desired, modified to suit your wishes. In a multi-lingual country, configuration is possible in the official national language of your choice.

**i** For technical reasons and in particular to improve the quality of "PEUGEOT CONNECT services" services to customers, the manufacturer reserves the right to carry out updates to the vehicle's on-board telematic system.

\*\* Depending on the geographical cover of "PEUGEOT Connect SOS", "PEUGEOT Connect Assistance" and the official national language selected by the owner of the vehicle.

The list of countries covered and PEUGEOT CONNECT services is available from dealers or on the website in your country.

# 7-inch touch screen

## GPS satellite navigation - Multimedia audio - Bluetooth® telephone



	Contents
First steps	6
Steering mounted controls	8
Menus	9
Navigation	10
Navigation - Guidance	18
Traffic	22
Radio Media	24
Radio	30
DAB (Digital Audio Broadcasting) radio	32
Media	34
Settings	38
Connected services	46
MirrorLink™	46
CarPlay®	50
Telephone	52
Frequently asked questions	60

**i** The system is protected in such a way that it will only operate in your vehicle.

**!** As a safety measure, the driver should only carry out operations which require prolonged attention while the vehicle is stationary. The display of an energy economy mode message signals that electrical systems operating are going into standby. Refer to the energy economy mode section.

# First steps

Use the buttons to the left of the touch screen for access to the menu carousels, then press the virtual buttons in the touch screen. Each menu is displayed in one or two pages (primary page and secondary page).



**i** In very hot conditions, the system may go into stand-by (screen and sound completely off) for a minimum period of 5 minutes.

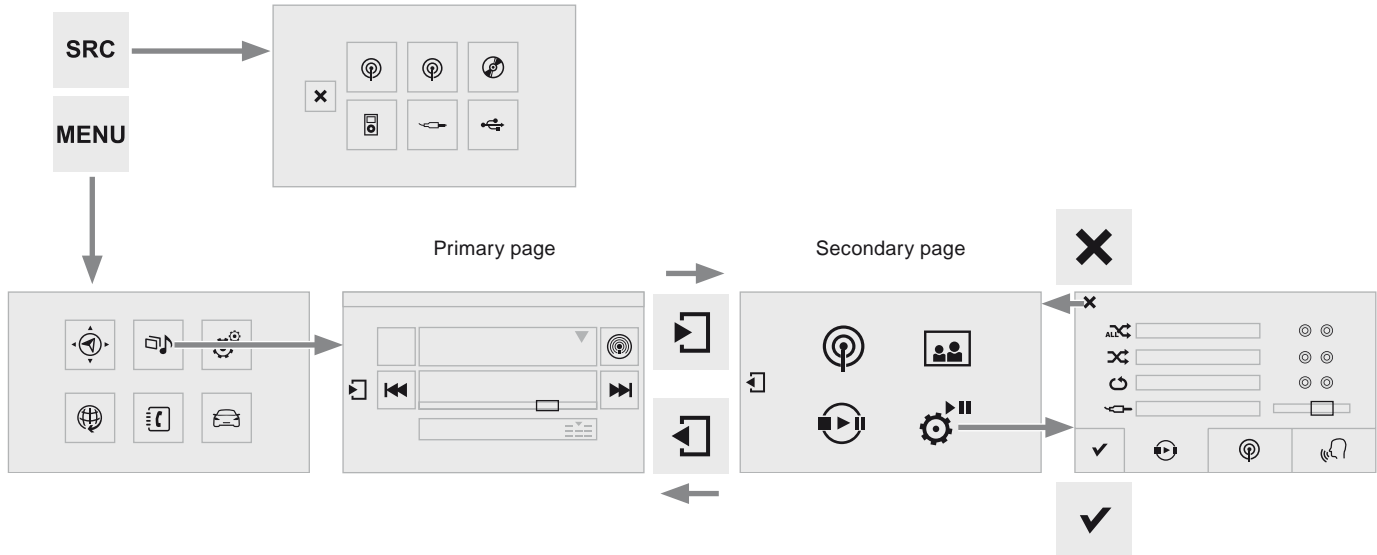

Short-cuts: using the touch buttons in the upper band of the touch screen, it is possible to go directly to the selection of audio source, the list of stations (or titles, depending on the source).

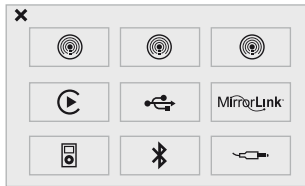

Selection of audio source (depending on version):

- FM /DAB\* /AM stations\*.
- USB memory stick.
- CD player (located in the glove box)\*.
- Smartphone via MirrorLink™ or CarPlay®.
- Telephone connected by Bluetooth\* and with Bluetooth\* audio streaming.
- Media player connected to the auxiliary socket (jack, cable not supplied).

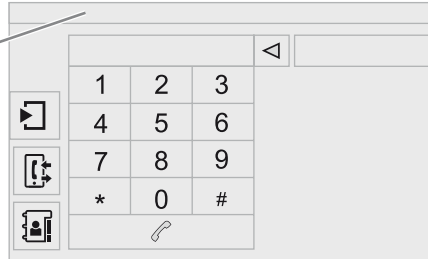

**MENU**

Press on **Menu** to display the menu carousel.

**SRC**

Press on **SRC** to display the audio sources carousel.

Volume adjustment (each source is independent, including traffic announcements (TA) and navigation instructions).



With the engine running, press to mute the sound.  
With the ignition off, press to switch the system on.

**i** In very hot conditions, the volume may be limited to protect the system. The return to normal takes place when the temperature in the passenger compartment drops.

**i** The screen is of the "resistive" type, it is necessary to press firmly, particularly for "flick" gestures (scrolling through a list, moving the map...). A simple wipe will not be enough. Pressing with more than one finger is not recognised. The screen can be used when wearing gloves. This technology allows use at all temperatures.

**!** To clean the screen, use a soft non-abrasive cloth (spectacles cloth) without any additional product. Do not use pointed objects on the screen. Do not touch the screen with wet hands.

\* Depending on equipment.

# Steering mounted controls

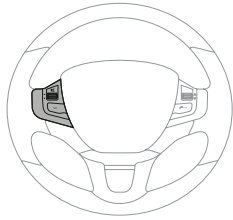

Press: mute on / off.



Increase volume.



Decrease volume.



Change audio source: radio, media.

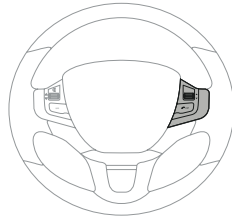

Radio, rotate: automatic search for the previous / next station.  
Radio, press: preset stations.  
Media, rotate: previous / next track.  
Press: confirm a selection.



Telephone: start or answer a call.  
Call in progress: telephone menu (end call, secret mode, hands-free mode).  
Telephone, press and hold: reject an incoming call, end a call in progress; other than call in progress, telephone menu.  
Radio: display the list of stations.  
Media: display the list of tracks.  
Radio, press and hold: update the list of stations received.

# Menus



## Navigation

(Depending on equipment)



Enter navigation settings and choose a destination.



## Radio Media

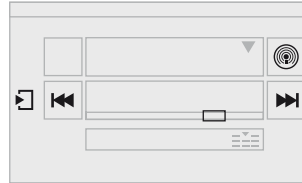

Select an audio source, a radio station, display photographs.



## Settings

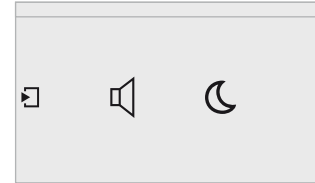

Adjust the settings for sound (balance, ambience, ...) and the display (language, units, date, time, ...).



## Connected services

(Depending on equipment)

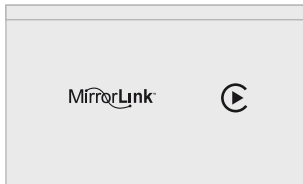

Operate certain applications on your smartphone via MirrorLink™ or CarPlay®.



## Telephone

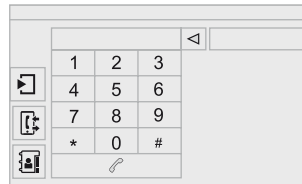

Connect a telephone by Bluetooth®. Access to the CarPlay® function after connection of your smartphone by USB cable.



## Driving

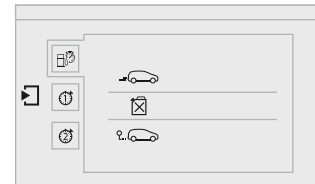







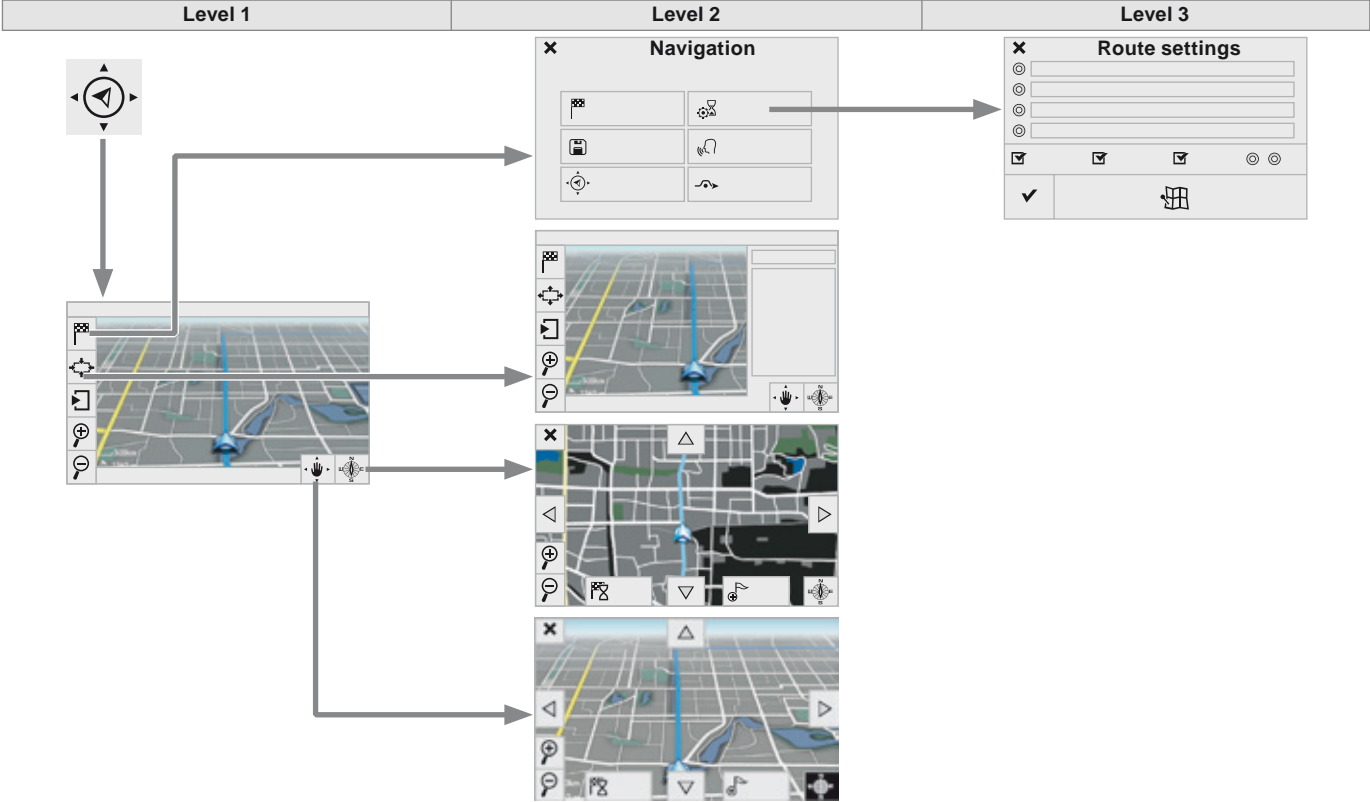

















Access to the trip computer. Activate, deactivate or enter settings for certain vehicle functions.



# Navigation





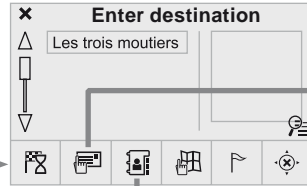
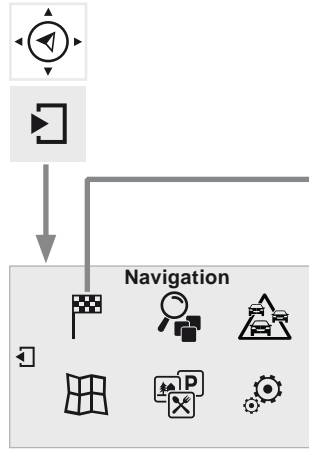



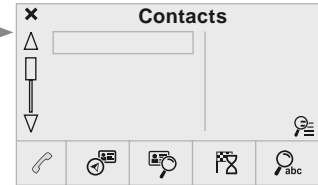













Level 1		Level 2		Level 3		Comments
  <p style="text-align: center;"><b>Navigation</b> ↓ <b>Settings</b> <b>Navigation</b></p>	 <p><b>Enter destination</b></p>	 <p><b>Route settings</b></p>	 Fastest	<p>Choose the navigation criteria. The map displays the route chosen according to these criteria.</p>		
			 Shortest			
			 Time/distance			
			 Ecological			
			 Tolls			
			 Ferries			
			 Traffic			
			 Strict-Close			
			 Show route on map	Display the map and start navigation.		
			 Confirm	Save the options.		
 <b>Save current location</b>			Save the current address.			
 <b>Stop navigation</b>			Delete the navigation information.			
 <b>Voice synthesis</b>			Choose the volume for voice and announcement of street names.			
 <b>Diversion</b>			Detour from your initial route by a determined distance.			
 <p style="text-align: center;"><b>Navigation</b></p>	 <b>Text mode</b>			Display in text mode		
	 <b>Zoom in</b>			Zoom in.		
	 <b>Zoom out</b>			Zoom out.		
	 <b>Full screen</b>				Display in full screen mode. Use the arrows to move the map.	
	 <b>2D map</b>				Switch to 2D map.	











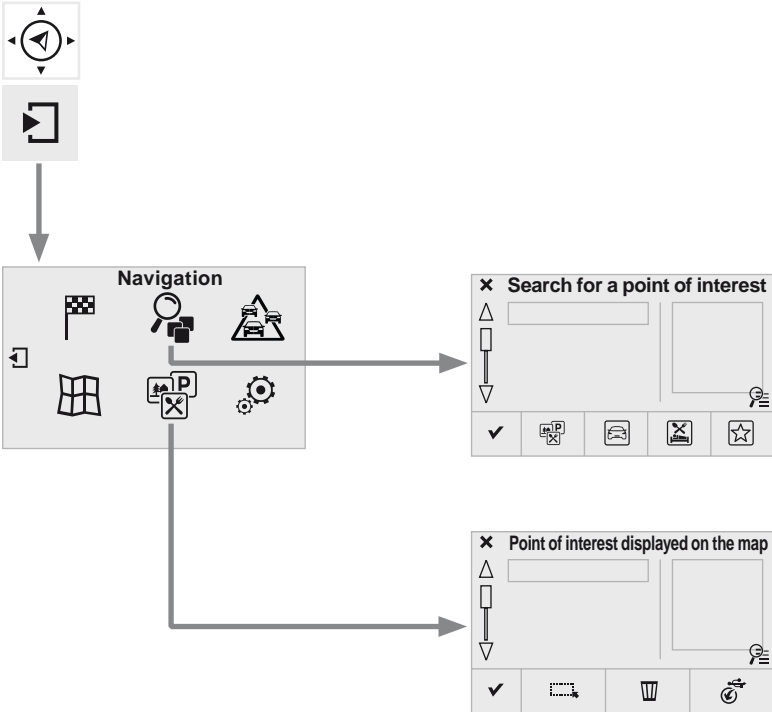







For managing contacts and their addresses, refer to the "Telephone" section.











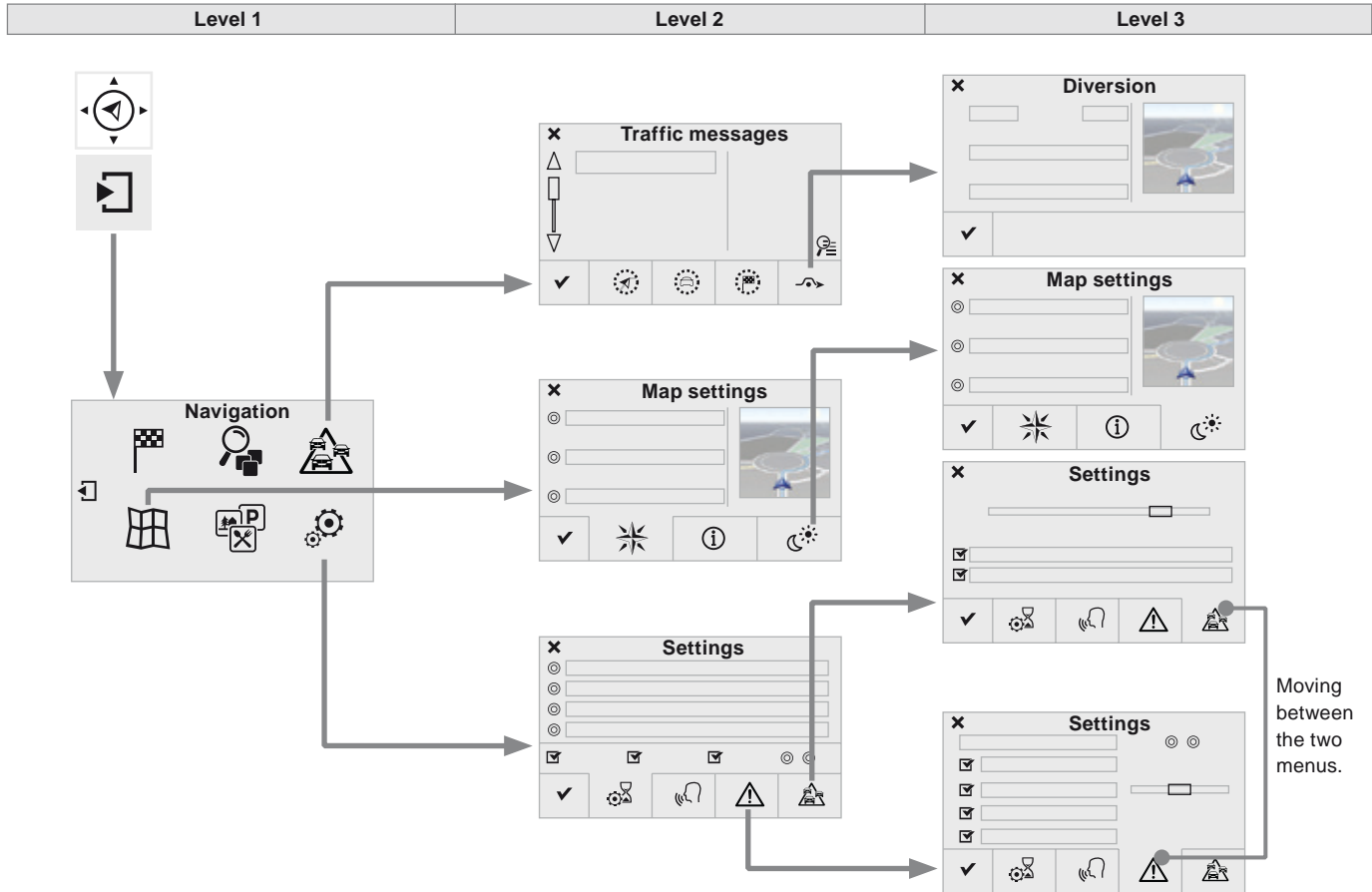











To use the telephone functions, refer to the "Telephone" section.

Level 1		Level 2		Level 3		Comments
  	<p style="text-align: center;"> <b>Navigation</b>  ↓  <b>Secondary page</b>  ↓  <b>Enter destination</b> </p>		<b>Address</b>		Current loc.	Address settings
					Point of interest	
					Town center	
					Save	Save the current address.
					Add waypoint	Add a waypoint to the route.
					Navigate to	Press to calculate the route.
			<b>Contacts</b>		Addresses	Select a contact then calculate the route.
					View	
					Navigate to	
					Search for contact	
	Call					
	<b>On the map</b>		Display the map and zoom to view the roads.			
	<b>Itinerary</b>		Create, add or delete a waypoint or view the itinerary.			
	<b>Stop</b>		Delete navigation information.			
	<b>Navigate to</b>		Press to calculate the route.			



Level 1		Level 2		Level 3	Comments
  	Navigation	 <b>All POIs</b>		List of categories available. After choosing the category, select the points of interest.	
	↓	 <b>Motor</b>			
	Secondary page	 <b>Dining/hotels</b>			
	↓	 <b>Personal</b>			
	Search for POI	 <b>Search</b>		Save the settings.	
  	Navigation	 <b>Select all</b>		Choose the display settings for POIs.	
	↓	 <b>Delete</b>			
	Secondary page	 <b>Import POIs</b>			
	Show POIs	 <b>Confirm</b>		Save the options.	



Level 1		Level 2		Level 3		Comments	
  	Navigation ↓ Secondary page ↓ Traffic messages	 <b>On the route</b>				Settings for the choice of messages and the filter radius.	
		 <b>Around vehicle</b>					
		 <b>Near destination</b>					
		 <b>Detour</b>	<input type="radio"/>	Detour over a distance			
			<input type="radio"/>	Recalculate route			
	<input checked="" type="checkbox"/> <b>Finish</b>				Save your selections.		
  	Navigation ↓ Secondary page ↓ Map settings	 <b>Orientation</b>		<input type="radio"/>	Flat view north heading	Choose the display and orientation of the map.	
				<input type="radio"/>	Flat view vehicle heading		
				<input type="radio"/>	Perspective view		
		 <b>Maps</b>					
		 <b>Aspect</b>	<input type="radio"/>	"Day" map colour			
			<input type="radio"/>	"Night" map colour			
			<input type="radio"/>	Automatic day/night			
	<input checked="" type="checkbox"/> <b>Confirm</b>				Save the settings.		
  	Navigation ↓ Secondary page ↓ Settings	 <b>Route settings</b>				Enter settings and choose the volume for the voice and announcement of street names.	
		 <b>Voice</b>					
		 <b>Alarm!</b>					
		 <b>Traffic options</b>					
			<input checked="" type="checkbox"/> <b>Confirm</b>				Save your selections.



# Navigation - Guidance

## Choosing a new destination

### Towards a new destination



Press on **Navigation** to display the primary page.



Press on the secondary page.



Select "**Enter destination**".



Select "**Address**".



Select the "**Country**:" from the list offered, then in the same way the "**City**:" or its post code, the "**Road**:", the "**N**°:". Confirm each time.



Select "**Save**" to save the address entered as a contact entry. The system allows up to 200 entries.



Select "**Navigate to**".



Choose the navigation criteria: "**Fastest**" or "**Shortest**" or "**Time/distance**" or "**Ecological**".



Choose the restriction criteria: "**Tolls**", "**Ferries**", "**Traffic**", "**Strict**", "**Close**".



Select "**Confirm**".

Or



Press on "**Show route on map**" to start navigation.



To delete navigation information, press on "**Settings**".



Press on "**Stop navigation**".



To resume navigation press on "**Settings**".



Press on "**Resume guidance**".

## Towards a recent destination



Press on **Navigation** to display the primary page.



Press on the secondary page.



Select "**Enter destination**".

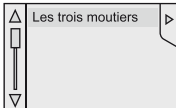

Select an address from the list offered.



Select "**Navigate to**".



Select the criteria then "**Confirm**" or press "**Show route on map**" to start navigation.

## Towards a contact



To be able to use navigation "towards a contact in the directory", it is first necessary to enter the address for your contact.



Press on **Navigation** to display the primary page.



Press on the secondary page.



Select "**Enter destination**".



Select "**Contacts**".

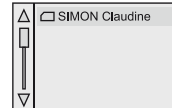

Select a destination from the contacts in the list offered.



Select "**Navigate to**".



Select the criteria then "**Confirm**" to start navigation.

## Towards GPS coordinates



Press on **Navigation** to display the primary page.



Press on the secondary page.



Select "**Enter destination**".



Select "**Address**".



Enter the "**Longitude**:" then the "**Latitude**:".



Select "**Navigate to**".



Select the criteria then "**Confirm**" or press "**Show route on map**" to start navigation.

## Towards a point on the map



Press on **Navigation** to display the primary page.



Press on the secondary page.



Select "**Enter destination**".



Select "**On the map**".

Zooming in on the map shows points with information.

A long press on a point opens its content.

## Towards points of interest (POI)

Points of Interest (POI) are listed in different categories.



Press on **Navigation** to display the primary page.



Press on the secondary page.



Select "**Search for POI**".



Select "**All POIs**".

Or



"**Motor**",

Or



"**Dining/hotels**".

**i** An annual mapping update allows new points of interest to be presented to you.  
You can also update the Risk areas / Danger areas every month.  
The detailed procedure is available on:  
<http://peugeot.navigation.com>.

## Risk areas / Danger zone alert settings



Press on **Navigation** to display the primary page.



Press on the secondary page.



Select "**Settings**".



Select "**Alarm!**" (Alert).

It is then possible to activate Risk areas alerts then:

- "Audible warning"
- "Alert only when navigating"
- "Alert only for overspeed"
- "Display speed limits"
- Timing: the choice of timing allows the time before giving a Risk areas alert to be defined.



Select "**Confirm**".

**!** This series of alerts and displays is only available if Risk areas have first been downloaded and installed on the system.

## Traffic

### Traffic information

#### Display of messages



Press on **Navigation** to display the primary page.



Press on the secondary page.



Select "**Traffic messages**".

Choose filter settings for:



"**On the route**",



"**Around**",



"**Near destination**", filters to fine-tune the list of messages.

Press again to remove the filter.



Select the message from the list offered.



Select the magnifying glass to have voice information.

**i** TMC (Traffic Message Channel) messages on GPS-Navigation contain traffic information transmitted in real time.

### Setting filters



Press on **Navigation** to display the primary page.



Press on the secondary page.



Select "**Settings**".



Select "**Traffic options**".



Select:  
 - "**Be advised of new messages**",  
 - "**Speak messages**".

Then enter the filter radius.



Select "**Confirm**".

**i** We recommend a filter radius of:

- 12 miles (20 km) in urban areas,
- 30 miles (50 km) on motorways.

### Receiving TA messages



Press on **Navigation** to display the primary page.



Press on the secondary page.



Select "**Settings**".



Select "**Voice**".

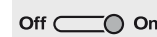







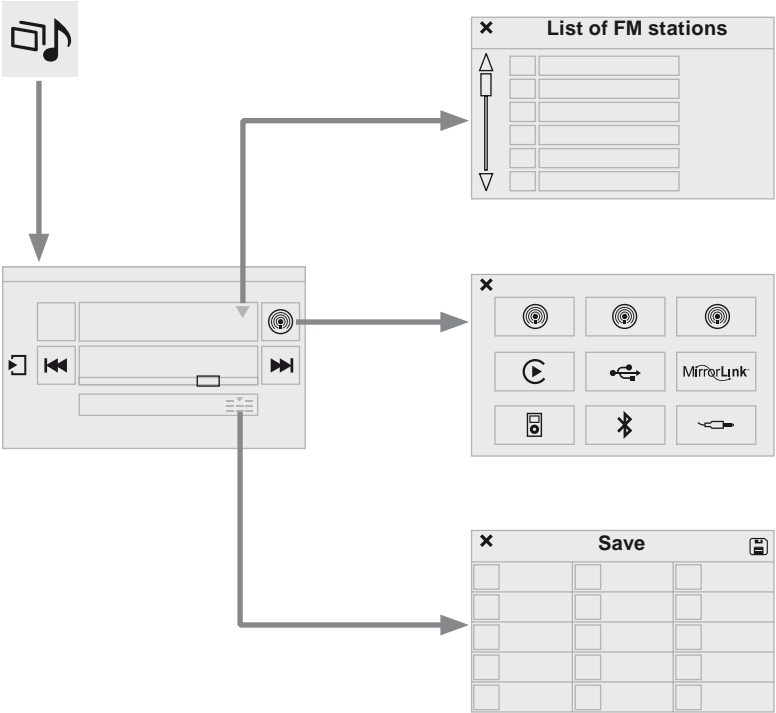











Activate / Deactivate "**Traffic (TA)**".

**i** The TA (Traffic Announcement) function gives priority to TA alert messages. To operate, this function needs good reception of a radio station transmitting this type of message. When a traffic report is transmitted, the current audio source is interrupted automatically to play the TA message. Normal playback of the audio source resumes at the end of the transmission of the message.









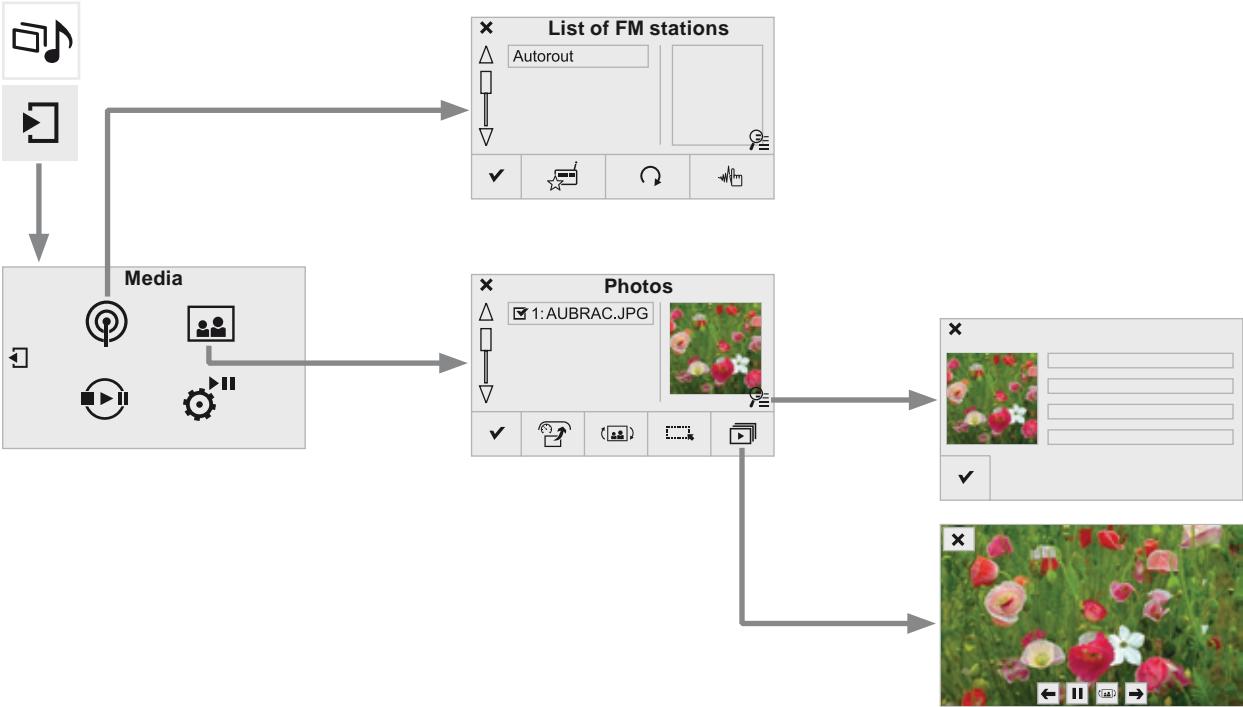









# Radio Media











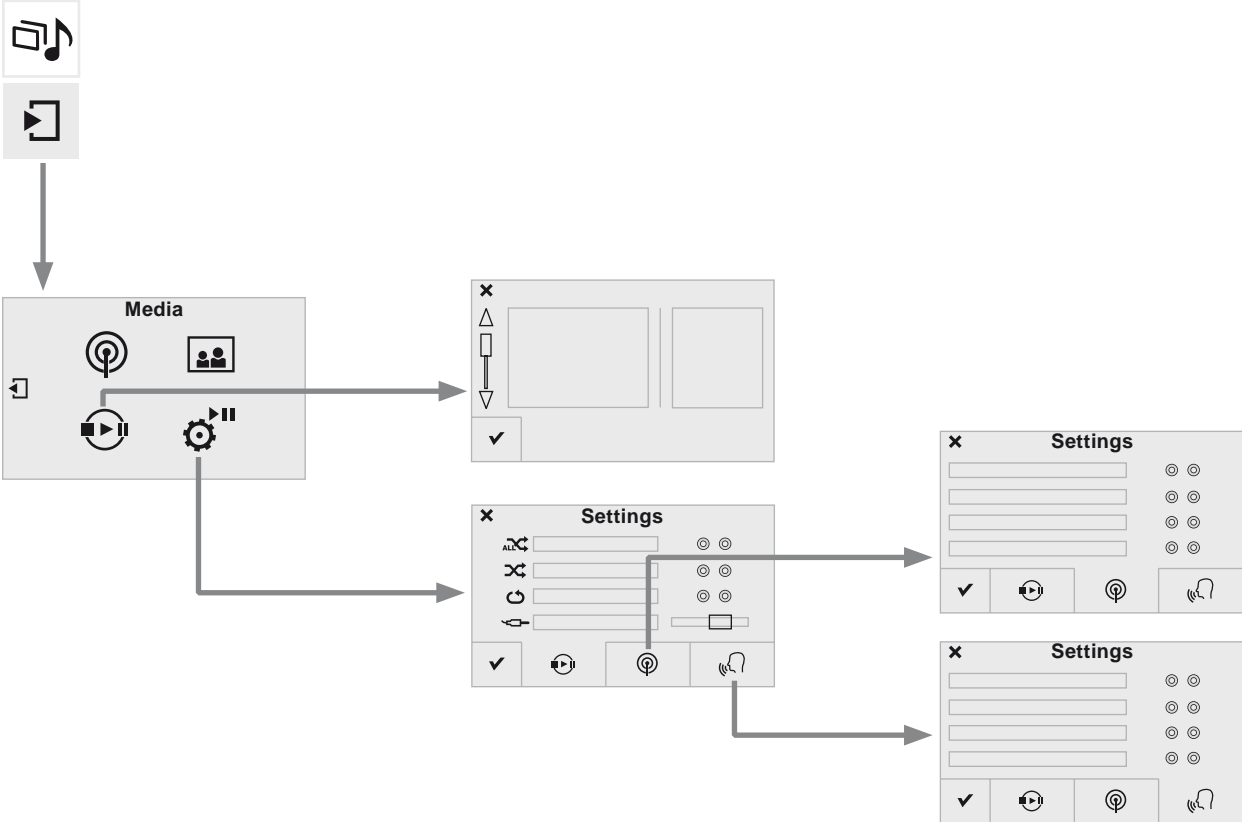



Level 1		Level 2		Comments
 	<b>Radio Media</b> ↓ <b>List</b>		<b>List of FM stations</b>	Press on a radio station to select it.
 	<b>Radio Media</b> ↓ <b>Source</b>	 <b>FM Radio</b>  <b>DAB Radio</b>  <b>AM Radio</b>  <b>USB</b>  <b>CD</b>  <b>MirrorLink™</b>  <b>CarPlay®</b>  <b>iPod</b>  <b>Bluetooth</b>  <b>AUX</b>		Select change of source.
 	<b>Radio Media</b> ↓ <b>Save</b>			Press an empty location to Save it.





Level 1		Level 2		Level 3		Comments	
  	<b>Radio Media</b> ↓ <b>Secondary page</b> ↓ <b>Radio list</b>	 <b>Save</b>				Press a radio station to select it.	
		 <b>Update list</b>				Update the list of stations received.	
		 <b>Frequency</b>				Enter the desired radio frequency.	
		 <b>Confirm</b>				Save the settings.	
  	<b>Radio Media</b> ↓ <b>Secondary page</b> ↓ <b>Photos</b>	 <b>Home screen</b>				Display the selected photo in the home page.	
		 <b>Rotate</b>				Rotate the photo 90°.	
		 <b>Select all</b>				Select all the photos in the list. Press again to deselect.	
		 <b>Slideshow</b>	 Previous photo.				Display the photos in sequence, full-screen. The system supports the following image formats: .gif, .jpg, .bmp, .png.
			 Pause / Play.				
			 Next photo.				
 <b>Full screen</b>					Display the selected photo full-screen.		



Level 1		Level 2		Level 3		Comments	
	<b>Radio Media</b>					Presentation of the last media used.	
	<b>Secondary page</b>						
	<b>Media list</b>						
	<b>Radio Media</b> ↓ <b>Secondary page</b> ↓ <b>Settings</b>		<b>Media</b> ↓ <b>Settings</b>	 Shuffle (all tracks)	Choose the play settings.		
				 Shuffle (current album)			
				 Repeat			
				 Aux. amplification			
			<b>Radio</b> ↓ <b>Settings</b>	<input type="checkbox"/> RDS options	Activate or deactivate the settings.		
				<input type="checkbox"/> DAB/FM station tracking			
				<input type="checkbox"/> Display Radio Text			
				<input type="checkbox"/> Digital radio slideshow display			
			<b>Announcements</b> ↓ <b>Settings</b>	<input type="checkbox"/> Traffic announcements (TA)	Activate or deactivate the settings.		
				<input type="checkbox"/> News - Weather			
				<input type="checkbox"/> Sport - Programm info			
				<input type="checkbox"/> Flash - Unforeseen events			
			<b>Confirm</b>				Save the settings.

# Radio

## Selecting a station



Press on **Radio Media** to display the primary page.



Select "**List**" in the primary page.

Or



Press on **Radio Media** to display the primary page.



Press on the secondary page.



Select "**Radio list**" in the secondary page.

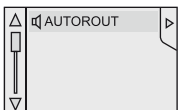

Select a radio station from the list offered.



Select "**Update list**" to refresh the list.

To select a preset radio station.



Press on **Radio Media** to display the primary page.



Select "**Save**".

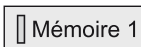

Select a preset radio station in the list.



If necessary, select change of source.



Select "**FM Radio**".

Or



"**AM Radio**".

**!** Radio reception may be affected by the use of electrical equipment not approved by PEUGEOT, such as a USB charger connected to the 12 V socket. The exterior environment (hills, buildings, tunnel, car park, below ground...) may prevent reception, even in RDS station tracking mode. This phenomenon is normal in the propagation of radio waves and is in no way indicative of a fault with the audio system.

## Changing a radio frequency



Press on **Radio Media** to display the primary page.

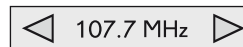

**By automatic frequency search**

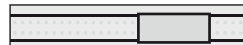

Press **◀** or **▶** to move the cursor for an automatic search down or up for a radio frequency.

**THEN**



Select change source.



Select "**FM Radio**".

Or



"**AM Radio**".

OR



Press on **Radio Media** to display the primary page.



Press on the secondary page.



Press on **Frequency**.

THEN



Enter the frequency in full (e.g.: 92.10 MHz) using the keypad then **"Confirm"**.

FRANCE BLEU

### Changing radio station

Pressing the name of the current radio station brings up a list.

To change radio station press the name of the desired station.

## Presetting a station

Select a radio station or frequency (refer to the corresponding section).



Press on **"Save"** (preset).

Mémoire 1

Select a number in the list to preset the previously chosen radio station.

A long press on a number saves (presets) the station.

Or



A press on this button presets all of the stations one after the other.

## Recalling preset stations



Press on **Radio Media** to display the primary page.



Select **"Save"** (preset).

## Activating / Deactivating RDS



Press on **Radio Media** to display the primary page.



Press on the secondary page.



Select **"Settings"**.



Select **"Radio"**.

Off  On

Activate/deactivate **"RDS options"**.

**i** RDS, if activated, allows you to continue listening to the same station by automatic retuning to alternative frequencies. However, in certain conditions, coverage of an RDS station may not be assured throughout the entire country as radio stations do not cover 100 % of the territory. This explains the loss of reception of the station during a journey.

# DAB (Digital Audio Broadcasting) radio

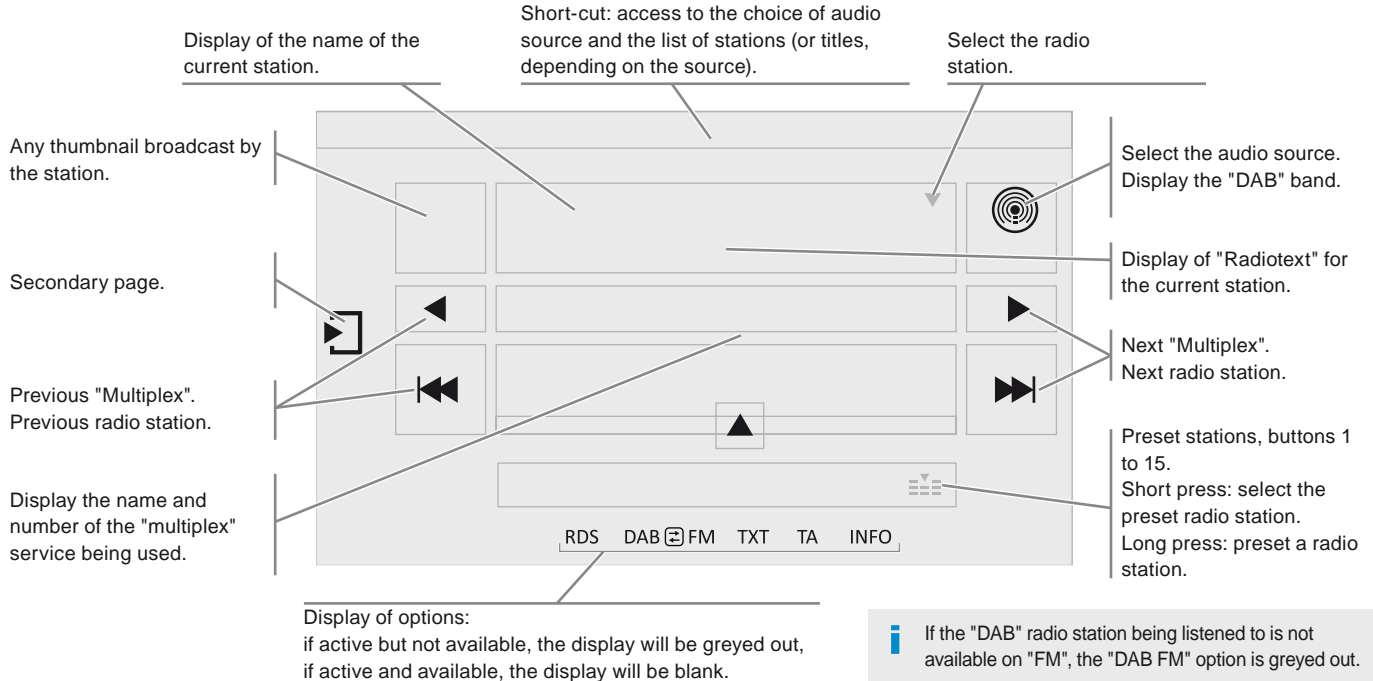

**!** Journaline® is a text-based information service designed for digital radio systems. It provides text-based information structured around topics and sub-topics. This service is available from the "LIST OF DAB STATIONS" page.

## Digital radio

- ! Digital radio provides higher quality reception and also the graphical display of current information on the radio station being listened to. Select "List" in the primary page.  
The range of multiplexes available is displayed in alphabetical order.



Press on **Radio Media** to display the primary page.



Select change of source.



Select "**DAB Radio**".



Select "**List**" in the primary page.

or

Select "**Radio list**" in the secondary page.

Select the radio station from the list offered.

## DAB / FM auto tracking

- i "DAB" does not cover 100% of the territory.  
When the digital radio signal is poor, "DAB/FM station tracking" allows you to continue listening to the same station, by automatically switching to the corresponding "FM" analogue station (if there is one).



Press on **Radio Media** to display the primary page.



Press on the secondary page.



Select "**Settings**".



Select "**Radio**".

Off  On

Select "**Digital/FM auto tracking**" then "**Confirm**".

- i If "DAB/FM station tracking" is activated, there is a difference of a few seconds when the system switches to "FM" analogue radio with sometimes a variation in volume.  
When the digital signal is restored, the system automatically changes back to "DAB".

- ! If the "DAB" station being listened to is not available on "FM" ("**DAB/FM**" option greyed out), or "DAB/FM station tracking" is not activated, the sound will cut out while the digital signal is too weak.



# Media

## USB port

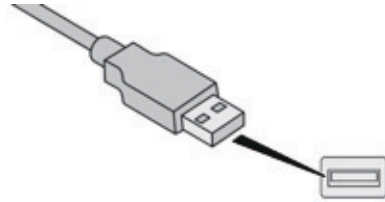

Insert the USB memory stick into the USB port or connect the USB device to the USB port using a suitable cable (not supplied).

**!** To protect the system, do not use a USB hub.

The system builds playlists (in temporary memory), an operation which can take from a few seconds to several minutes at the first connection. Reduce the number of non-music files and the number of folders to reduce the waiting time. The playlists are updated every time the ignition is switched off or on connection of a USB memory stick. The lists are memorised: if they are not modified, the subsequent loading time will be shorter.

## Auxiliary socket (AUX)



This source is only available if the "Auxiliary socket" option has been activated in the "Media" settings.

Connect the portable device (MP3 player...) to the auxiliary Jack socket using an audio cable (not supplied).

First adjust the volume of your portable device (to a high level). Then adjust the volume of your audio system. Display and management of the controls are via the portable device.

## CD player

Insert the CD in the player.

## Selecting the source



Press on **Radio Media** to display the primary page.



Select change of source.



Choose the source.



The steering mounted **SRC** (source) button can be used to go to the next media source, available if the source is active.



Press on **OK** to confirm the selection.

## Information and advice

The audio system will only play audio files with ".wma", ".aac", ".flac", ".ogg" and ".mp3" file extensions and with a bit rate of between 32 Kbps and 320 Kbps.

It also supports VBR (Variable Bit Rate) mode. No other type of file (.mp4, etc.) can be played. ".wma" files must be of the standard wma 9 type.

The sampling rates supported are 32, 44 and 48 KHz.

It is advisable to restrict file names to 20 characters, without using of special characters (e.g. " " ? ; ù) to avoid any playing and displaying problems.

In order to be able to play a recorded CDR or CDRW, when recording it is preferable to select the ISO 9660 level 1, 2 or Joliet standard.

If the disc is recorded in another format it may not be played correctly.

It is recommended that the same recording standard is always used for an individual disc, with as low a speed as possible (4x maximum) for optimum sound quality.

In the particular case of a multi-session CD, the Joliet standard is recommended.

Use only USB memory sticks formatted FAT 32 (file allocation table).

 To protect the system, do not use a USB hub.

 It is recommended that the USB cable for the portable device is used.

 The system supports USB mass storage devices, BlackBerry® devices or Apple® players via USB ports. The adaptor cable is not supplied. Control of the peripheral device is with the audio system controls. Other peripherals, not recognised on connection, must be connected to the auxiliary socket using a Jack cable (not supplied).

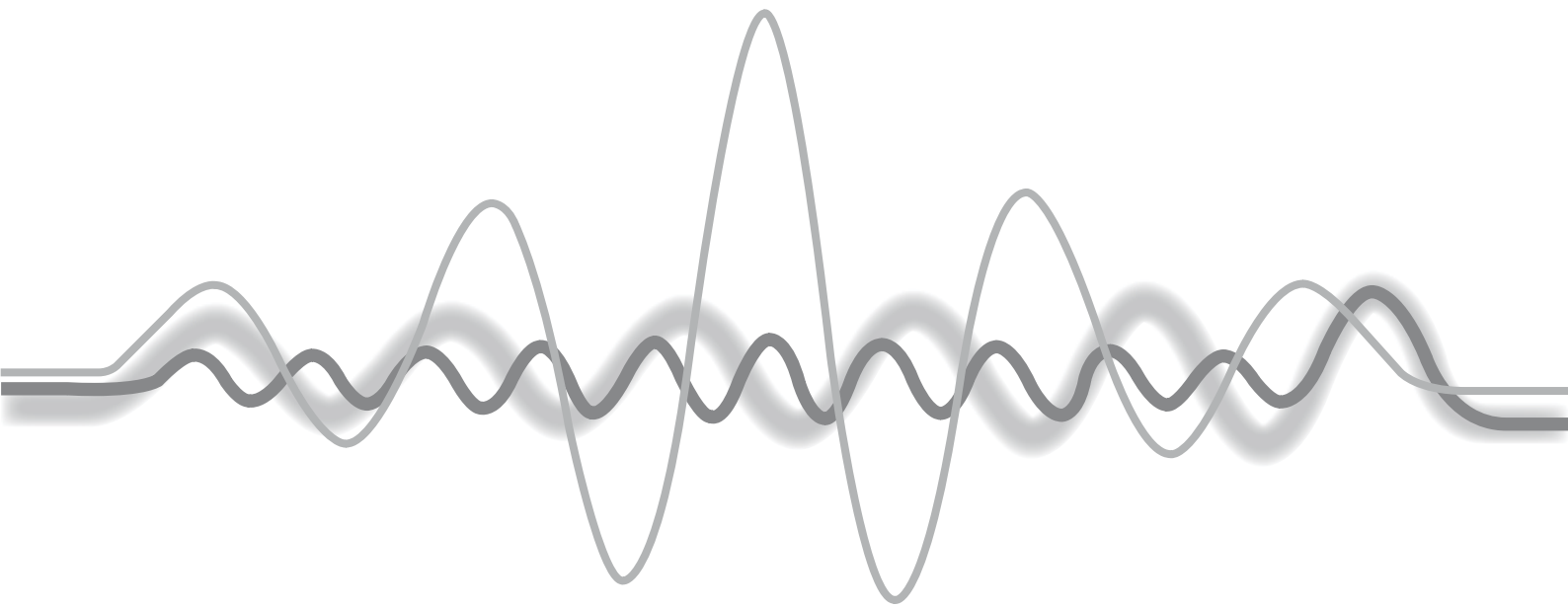

## Bluetooth® audio streaming

Streaming allows audio files on your telephone to be played through the vehicle's speakers.

Connect the telephone: see the "**Telephone**" section, then "**Bluetooth**".  
Choose the "**Audio**" or "**All**" profile.

If play does not start automatically, it may be necessary to start the audio playback from the telephone.

Control is from the peripheral device or by using the audio system buttons.

**!** Once connected in streaming mode, the telephone is considered to be a media source.  
It is recommended that you activate "**Repeat**" on the Bluetooth® peripheral.

## Connecting Apple® players

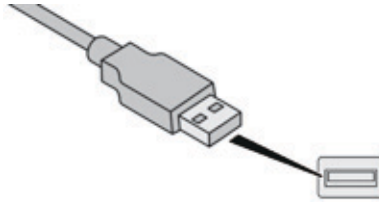

Connect the Apple® player to the USB port using a suitable cable (not supplied).  
Play starts automatically.









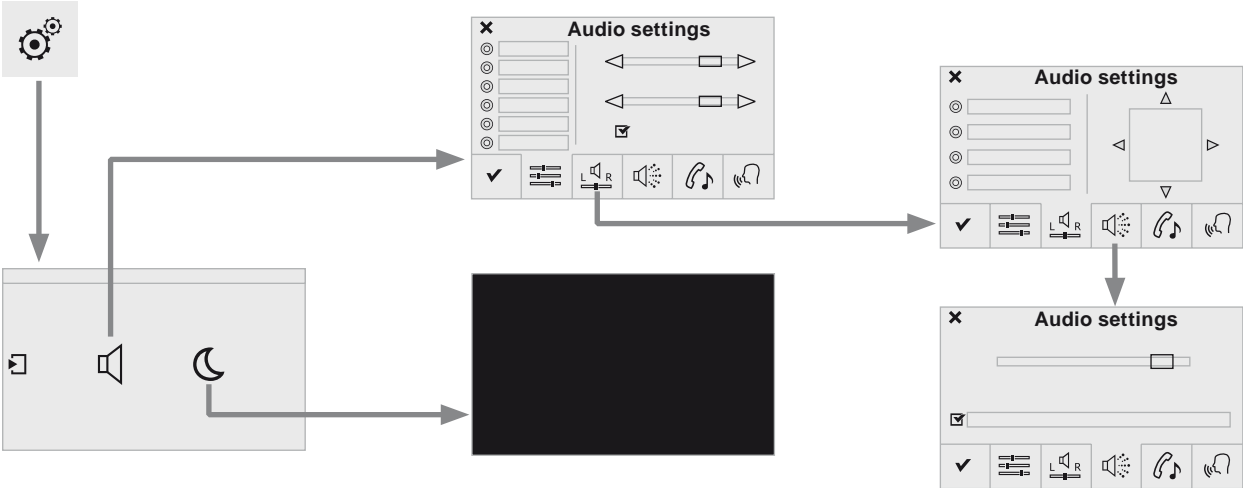

Control is via the audio system.

**i** The classifications available are those of the portable device connected (artists / albums / genres / playlists / audiobooks / podcasts).  
The default classification used is by artist. To modify the classification used, return to the first level of the menu then select the desired classification (playlists for example) and confirm to go down through the menu to the desired track.









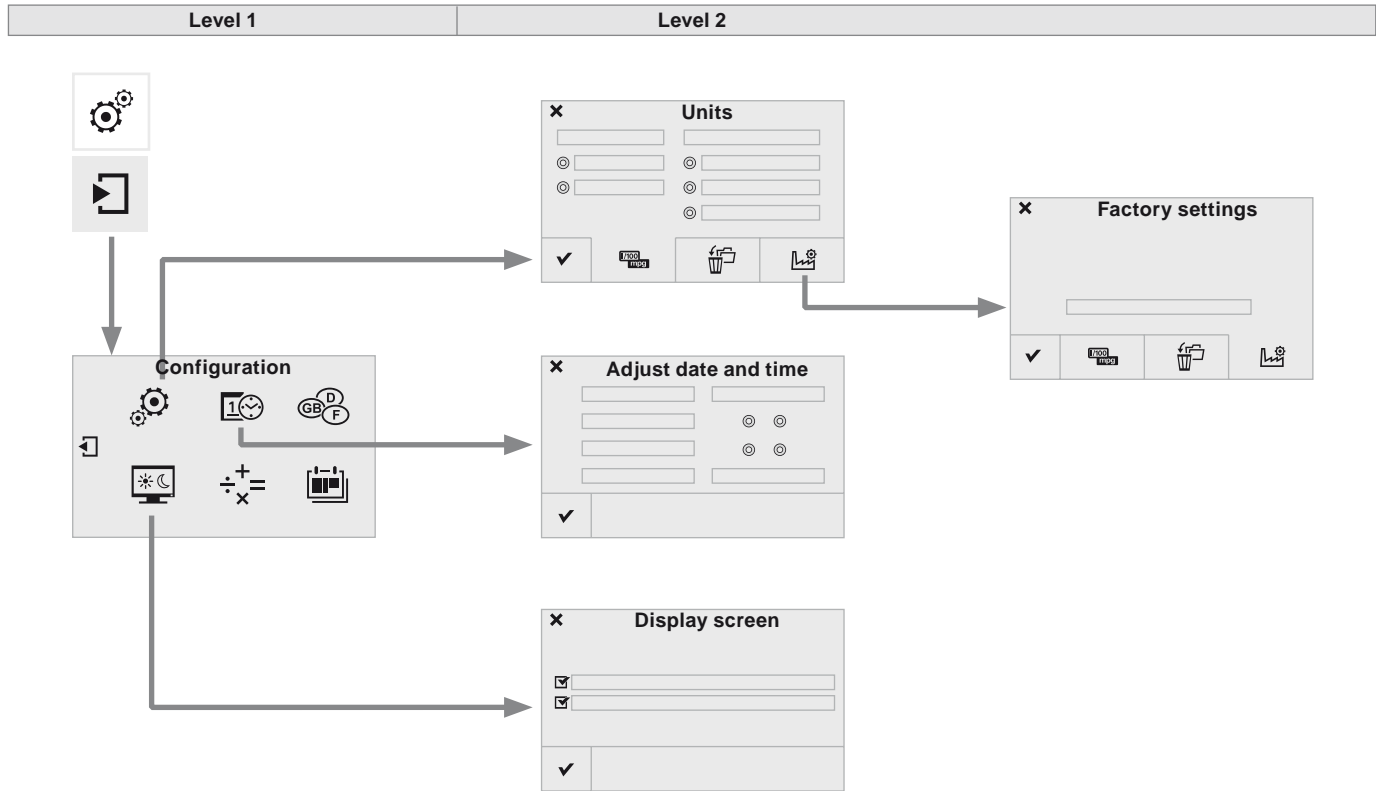



The version of software in the audio system may not be compatible with the generation of your Apple® player.

# Settings



Level 1		Level 2		Comments
 	<b>Settings</b> ↓ <b>Audio settings</b>		<b>Ambience</b>	Choose the sound ambience.
			<b>Balance</b>	Sound distribution using the Arkamys® system.
			<b>Sound effects</b>	Set the volume or activate the link to vehicle speed.
			<b>Ringtones</b>	Set the telephone ringtone and volume.
			<b>Voice</b>	Set the volume and voice for speaking street names.
			<b>Confirm</b>	Save your settings.
 	<b>Settings</b> ↓ <b>Turn off screen</b>			Function that turns off the display. Pressing the screen reactivates it.









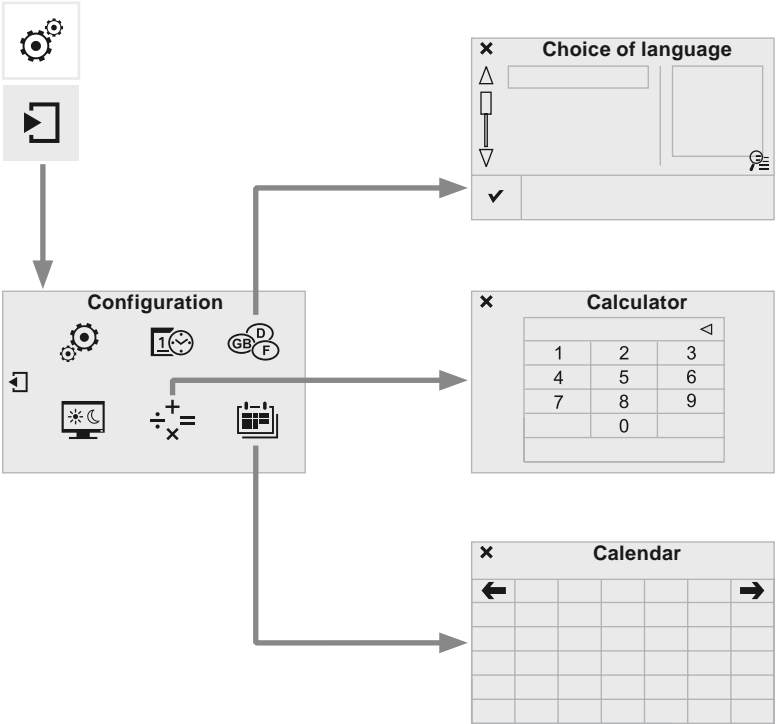

Level 1		Level 2		Comments
  	<b>Settings</b> ↓ <b>Secondary page</b> ↓ <b>System Settings</b>	 <b>Units</b>	Set the units used to display distance, fuel consumption and temperature.	
		 <b>Delete data</b>	Select the desired data in the list then press Delete.	
		 <b>Factory settings</b>	Return to factory settings.	
		<b>✓ Confirm</b>	Save the settings.	
  	<b>Settings</b> ↓ <b>Secondary page</b> ↓ <b>Time/Date</b>	<b>✓ Confirm</b>	Set the date and time then confirm.	
  	<b>Settings</b> ↓ <b>Secondary page</b> ↓ <b>Screen settings</b>	<input checked="" type="checkbox"/> <b>Activate automatic text scrolling</b>	Activate or deactivate the setting then confirm.	
		<input checked="" type="checkbox"/> <b>Activate animations</b>		
		<b>✓ Confirm</b>		



Level 1 | Level 2



Level 1		Level 2		Comments
  	<p><b>Settings</b></p> <p>↓</p> <p><b>Secondary page</b></p> <p>↓</p> <p><b>Languages</b></p>	✓	Confirm	Select the language then confirm.
  	<p><b>Settings</b></p> <p>↓</p> <p><b>Secondary page</b></p> <p>↓</p> <p><b>Calculator</b></p>			Select the calculator.
  	<p><b>Settings</b></p> <p>↓</p> <p><b>Secondary page</b></p> <p>↓</p> <p><b>Calendar</b></p>			Select the calendar.

## Audio settings



Press on **Settings** to display the primary page.



Select "**Audio settings**".



Select "**Ambience**".

Or



"**Balance**"

Or



"**Sound effects**"

Or



"**Ringtones**"

Or



"**Voice**".

**!** The distribution (or spatialisation using the Arkamys® system) of sound is an audio process that allows the audio quality to be adapted to the number of passengers in the vehicle. Available only with the 6-speaker configuration.

**!** The audio settings (**Ambience**, **Bass**, **Treble**: and **Loudness**) are different and independent for each sound source. The settings for **Distribution** and **Balance** are common to all sources.

- !**
- "**Ambience**" (choice of 6 musical ambiances)
  - "**Bass**:"
  - "**Treble**:"
  - "**Loudness**" (Activate/Deactivate)
  - "**Distribution**" ("**Driver**", "**All passengers**", "**Front only**")
  - "**Audible response from touch screen**"
  - "**Volume linked to speed**" (Activate/Deactivate)

**i** On-board audio: Arkamys® Sound Staging optimises sound distribution in the passenger compartment.

## Modifying system settings

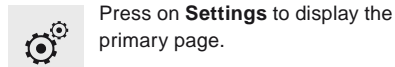

Press on **Settings** to display the primary page.



Press on the secondary page.



Select "**System Settings**".



Select "**Units**" to change the units of distance, fuel consumption and temperature.



Select "**Delete data**" to delete the list of recent destinations, personal points of interest, contacts in the list.



Choose the item then select "**Delete**".



Select "**Factory settings**" to return to the original settings.



Press on **Settings** to display the primary page.



Press on the secondary page.



Select "**Screen settings**".



Activate or deactivate "**Activate automatic text scrolling**" and "**Activate animations**".



Press on **Settings** to display the primary page.



Press on the secondary page



Select "**Time/Date**" to change the time zone, synchronisation with GPS, the time and its format, then the date.



The system does not manage changes between summer time and winter time automatically (according to country).



Select "**Languages**" to change language.



Select "**Calculator**" to display a calculator.



Select "**Calendar**" to display a calendar.

# Connected services

## MirrorLink™

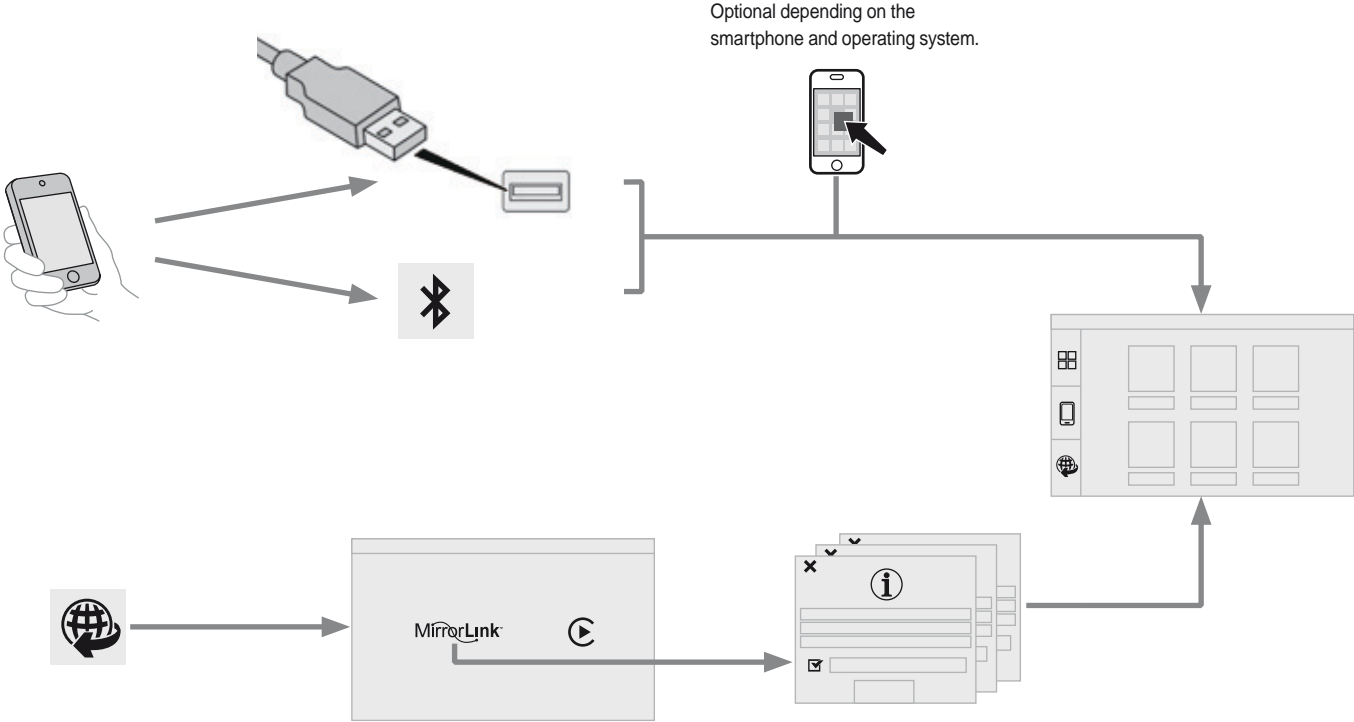

## MirrorLink™ smartphone connection

**!** As a safety measure and because it requires sustained attention by the driver, using a smartphone when driving is prohibited. All operations must be done with the **vehicle stationary**.

**i** The synchronisation of a smartphone allows applications on a smartphone that are adapted to the MirrorLink™ technology to be displayed in the vehicle's screen. The principles and standards are constantly evolving. For the communication process between the smartphone and the system to work correctly, the smartphone must be unlocked; update the operating system of your smartphone as well as the date and time in the smartphone and the system. For the list of eligible smartphones, connect to the brand's internet website in your country.

**!** As a safety measure, applications can only be viewed with the vehicle stationary; display is interrupted once the vehicle is moving.

**i** Please note:

- if your smartphone is supported, to make it "MirrorLink™" compatible, some phone manufacturers nevertheless invite you to first download a dedicated application.



When connecting a smartphone to the system, it is recommended that Bluetooth® be started on the smartphone



Connect a USB cable. The smartphone charges when connected by a USB cable.



From the system, press on "**Connected services**" to display the primary page.



Press on "**MirrorLink™**" to start the application in the system.



Start the application on the smartphone (optional, depending on the smartphone and operating system).

**OK**

During the procedure, several screen pages relating to certain functions are displayed. Accept to start and end the connection.

Once connection is established, an page is displayed with the applications already downloaded to your smartphone and adapted to MirrorLink™ technology. If only one application has been downloaded to the smartphone, it starts automatically.





Access to the different audio sources remains accessible in the margin of the MirrorLink™ display, using touch buttons in the upper bar. Access to the menus for the system is possible at any time using the dedicated buttons

### Voice recognition

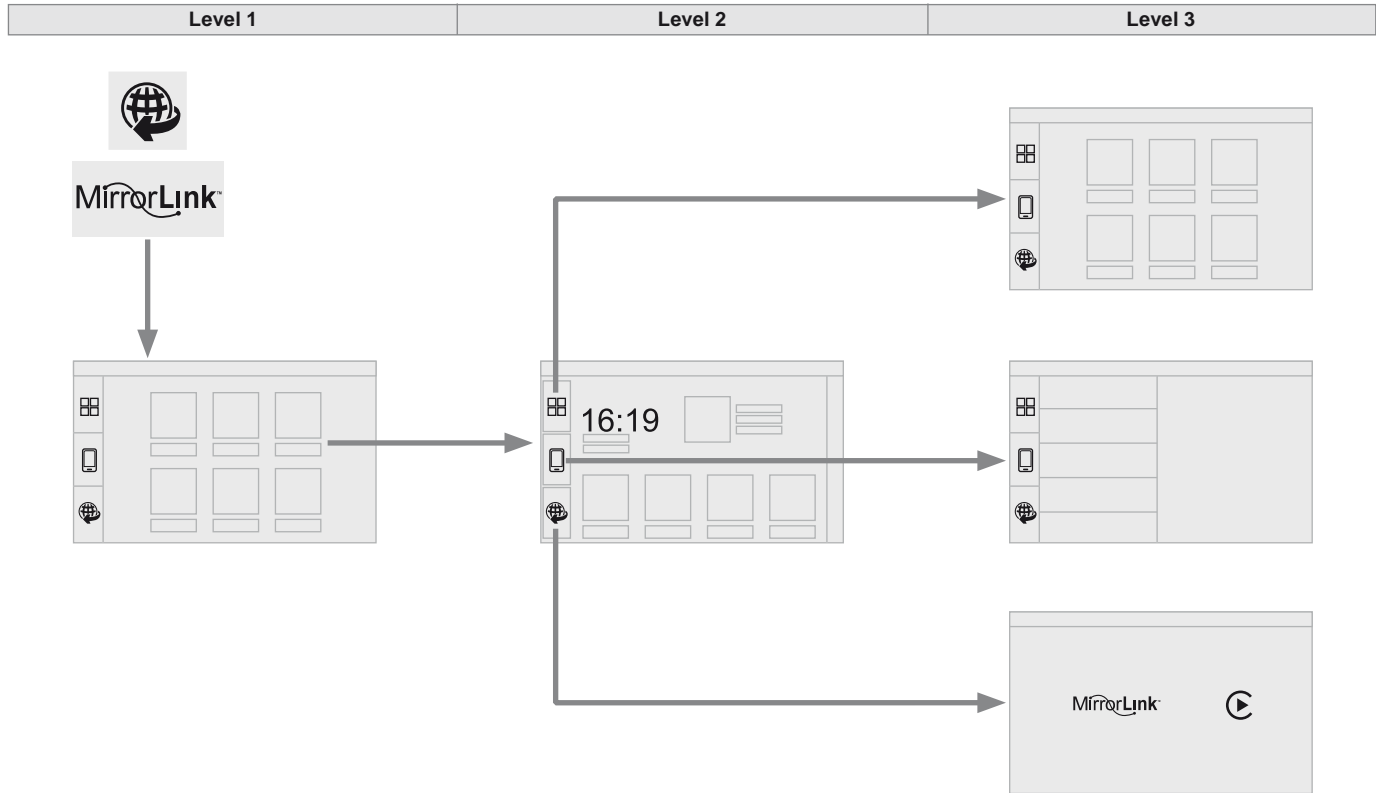
Press the end of the lighting control stalk to start voice recognition of your smartphone via the system.

Voice recognition requires a compatible smartphone connected to the vehicle by Bluetooth®.



Level 1		Level 2		Level 3		Comments
 	<p><b>Connected services</b></p> <p>↓</p> <p><b>MirrorLink™</b></p>					Access or return to the applications already downloaded to your smartphone and adapted to MirrorLink™ technology.
						Access to a menu list depending on the application chosen. "Back": abandon the current operation, go up one level. "Home": access or return to the "Car mode" page.
						Access to the "Connected services" primary page.



# CarPlay<sup>®</sup>

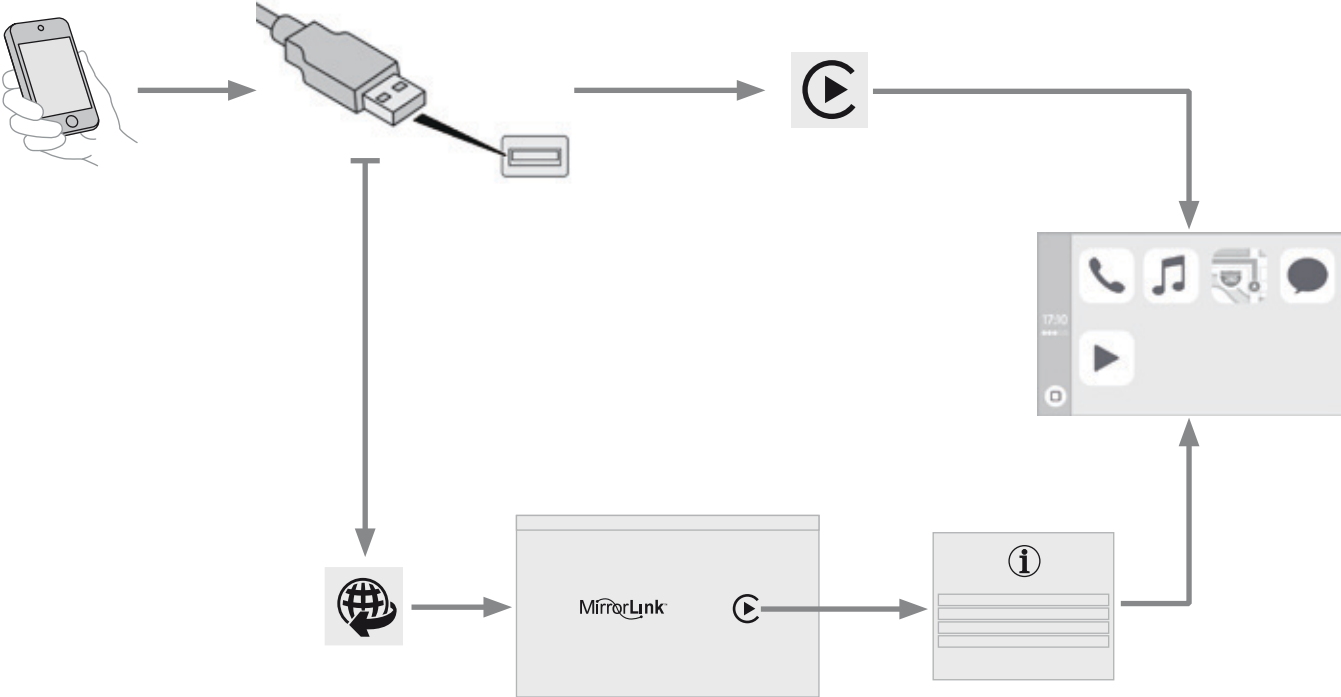

## CarPlay® smartphone connection

**!** As a safety measure and because it requires sustained attention by the driver, using a smartphone when driving is prohibited. All operations must be done with the **vehicle stationary**.

**i** The synchronisation of a smartphone allows applications on a smartphone that are adapted to the CarPlay® technology to be displayed on the vehicle's screen. As the principles and standards are constantly evolving, it is recommended that you update the operating system of your smartphone. For the list of eligible smartphones, connect to the brand's internet website in your country.

**i** As a safety measure, applications can only be viewed with the vehicle stationary; display is interrupted once the vehicle is moving.



Connect a USB cable. The smartphone charges when connected by a USB cable.



On connecting the USB cable, the **"Telephone"** function changes to **"CarPlay"** in the menu carousel. Press on **"CarPlay"** to display the CarPlay® interface.

Or



Connect the USB cable. The smartphone is charged while connected by the USB cable.



From the system, press on **"Connected services"** to display the primary page.



Press on **"CarPlay"** to display the CarPlay® interface.

**i** During the procedure, one or more screen pages relating to certain functions are displayed on connection.

When the telephone menu is displayed, connection of the USB cable causes the display to automatically change to CarPlay mode.









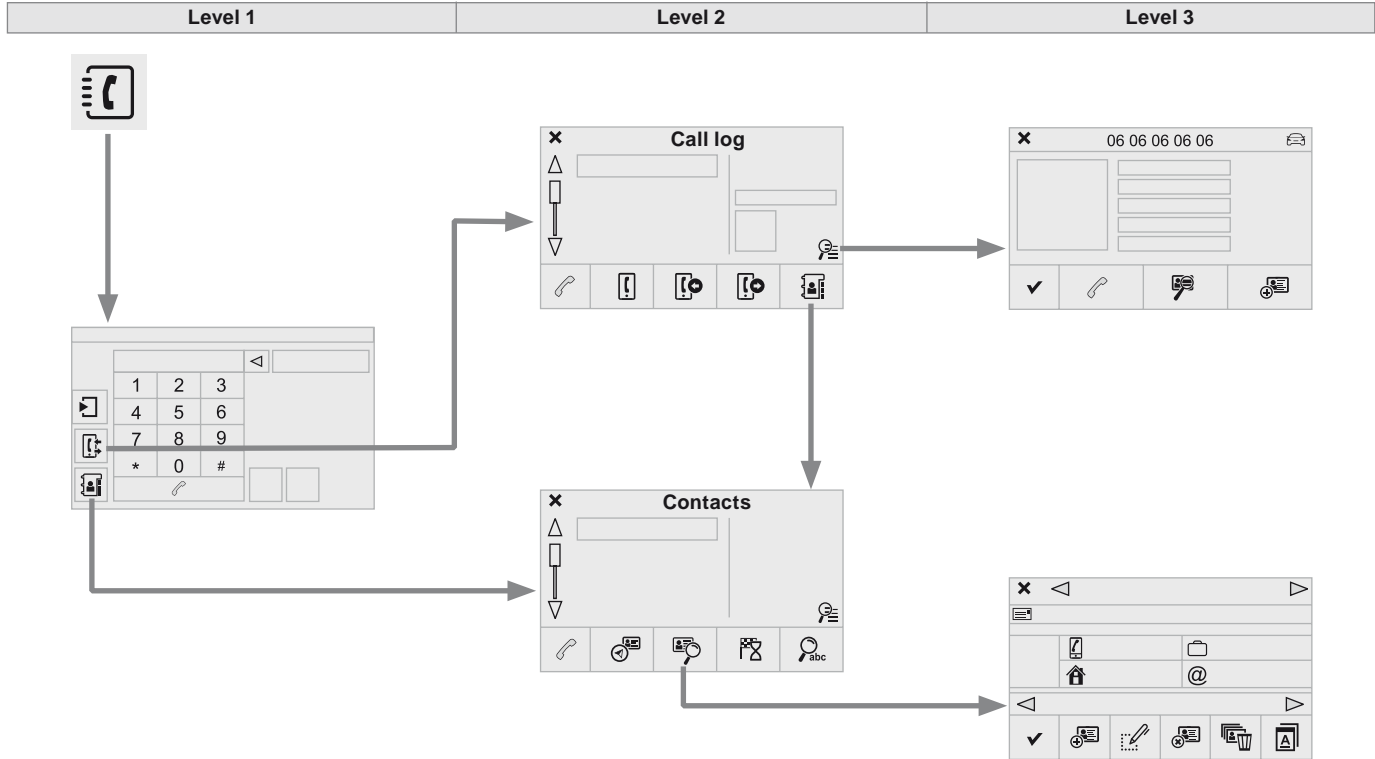













When another menu is displayed, on connection of a USB cable a message is displayed in the upper bar, indicating that CarPlay mode has been activated. Press Open to display CarPlay mode.

### Voice recognition









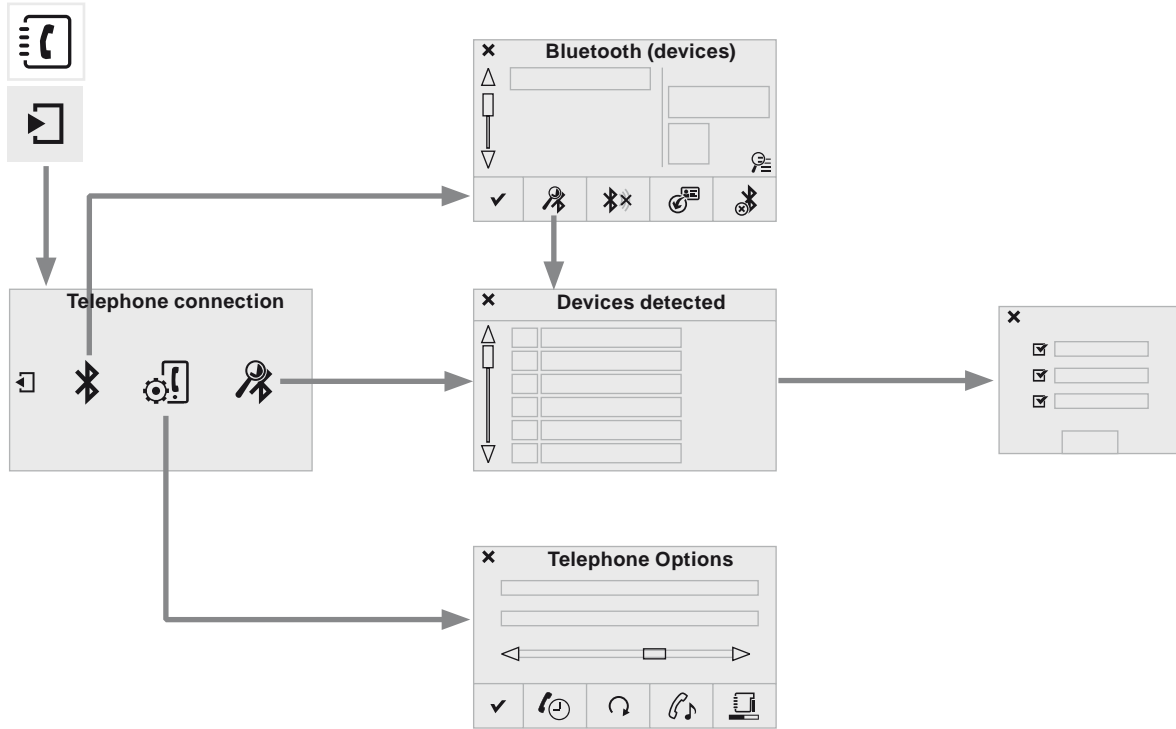









Press the end of the lighting control stalk to start voice recognition of your smartphone via the system.

# Telephone



Level 1		Level 2		Level 3		Comments
 	<b>Telephone</b> ↓ <b>Call log</b>	 <b>All calls</b>				After making choices, start the call.
		 <b>Incoming calls</b>				
		 <b>Outgoing calls</b>				
		 <b>Contacts</b>				
		 <b>Magnifying glass</b>	 View			
			 Create			
 <b>Call</b>						
 	<b>Telephone</b> ↓ <b>Contacts</b>	 <b>Addresses</b>				After making choices, start the call.
		 <b>View</b>	 Create			
			 Modify			
			 Delete			
			 Delete all			
			 By name			
			 Confirm			
		 <b>Navigate to</b>				
		 <b>Search for contact</b>				
 <b>Call</b>						



Level 1		Level 2		Level 3		Comments
  	Telephone connection ↓ Secondary page ↓ Bluetooth connection	 Search				Start the search for another peripheral device to connect.
		 Connect/Disconnect				Start or stop the Bluetooth® connection to the selected peripheral device.
		 Update				Import the contacts from the selected telephone to store them in the audio system.
		 Delete				Delete the selected telephone.
		 Confirm				Save the settings.
  	Telephone connection ↓ Secondary page ↓ Search for devices			<input checked="" type="checkbox"/> Telephone		Start the search for peripheral devices.
		Devices detected		<input checked="" type="checkbox"/> Audio streaming		
				<input checked="" type="checkbox"/> Internet		
  	Telephone connection ↓ Secondary page ↓ Telephone Options	 Put on hold				Cut the microphone temporarily so that the contact cannot hear your conversation with a passenger.
		 Update				Import the contacts from the selected telephone to save then in the audio system.
		 Ringtones				Choose the telephone ringtone and volume.
		 Memory info.				Contact records used and free, percentage of storage space used by internal contacts and Bluetooth® contacts.
		 Confirm				Save the settings.

## Pairing a Bluetooth® telephone

**!** For reasons of safety and because they require prolonged attention on the part of the driver, the operations for pairing the Bluetooth® mobile telephone to the hands-free system of the audio system must be carried out with the **vehicle stationary**.

### Procedure (short) from the telephone

In the Bluetooth® menu of your device, select the system name in the list of devices detected.

Enter a code of at least 4 figures in the device and confirm.

**✓** Enter this same code in the system, select **"OK"** and confirm.

### Procedure from the system

Activate the telephone's Bluetooth® function and ensure that it is "visible to all" (telephone configuration).



Press on **Telephone** to display the primary page.



Press on the secondary page.



Select **"Bluetooth connection"**.



Select **"Search for devices"**.  
The list of telephones detected is displayed.



If the telephone is not detected, it is recommended that you switch the Bluetooth® function on your telephone off and then on again.

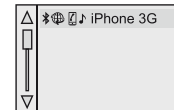

Select the name of the desired peripheral from the list and **"Confirm"**.



Enter a code of at least 4 figures for the connection then **"Confirm"**.

Enter this same code in the telephone then accept the connection.

The system offers to connect the telephone:

- in **"Telephone"** (hands-free kit, telephone only),
- in **"Audio streaming"** (streaming: wireless playing of audio files from the telephone),
- in **"Internet"** (internet browsing, only if your telephone is compatible with the "DUN" Dial-Up Networking Bluetooth® standard).

Select one or more profiles and confirm.

**!** The services available depend on the network, the SIM card and the compatibility of the Bluetooth® telephone used. Check the telephone manual and with your network provider for details of the services available to you.

**!** The ability of the system to connect with only one profile depends on the telephone. The three profiles may all connect by default.

Visit [www.peugeot.co.uk](http://www.peugeot.co.uk) for more information (compatibility, additional help, ...).

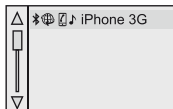

The recognised telephone appears in the list.

Depending on your telephone, you may be asked to accept automatic connection every time the ignition is switched on.

**!** Depending on the type of telephone, the system will ask you to accept or not the transfer of your contacts.



If not, select "**Update**".

On return to the vehicle, if the last telephone connected is present again, it is reconnected automatically and within around 30 seconds after switching on the ignition the pairing is done without any action on your part, with (Bluetooth® activated).

To modify the automatic connection mode, select the telephone in the list then select the desired profile.

## Connecting a Bluetooth® peripheral device

### Automatic reconnection

On switching on the ignition, the telephone connected when the ignition was last switched off is automatically reconnected, if this connection mode had been activated during the pairing procedure.

The connection is confirmed by the display of a message and the name of the telephone.

### Manual connection



Press on **Telephone** to display the primary page.



Press on the secondary page.



Select "**Bluetooth**" to display the list of paired peripherals.

Select the peripheral to connect.



Press on "**Search for devices**".

The connection is confirmed by the display of a message and the name of the telephone.



## Managing paired telephones

**i** This function allows the connection or disconnection of a peripheral device as well as the deletion of a pairing.



Press on **Telephone** to display the primary page.



Press on the secondary page.



Select "**Bluetooth**" to display the list of paired peripheral devices.

Select the peripheral in the list.



Select "**Search for devices**"

Or



"**Connect / Disconnect**" to start or end the Bluetooth connection with the selected device.

Or



"**Delete**" to delete the pairing.

## Receiving a call

An incoming call is announced by a ring and a superimposed display in the screen.



Make a short press on the steering mounted **TEL** button to accept an incoming call.



Make a long press



on the steering mounted **TEL** button to reject the call.

Or



Select "**End call**".

## Making a call

**!** Using the telephone is not recommended while driving. Park the vehicle. Make the call using the steering mounted controls.

### Calling a new number



Press on **Telephone** to display the primary page.



Enter the phone number using the digital keypad. Press "**Call**" to start the call.

### Calling a contact



Press on **Telephone** to display the primary page.



Or make a long press



on the steering mounted **TEL** button.



Select "**Contacts**".

Select the desired contact from the list offered.



Select "**Call**".

## Calling a recently used number



Press on **Telephone** to display the primary page.



Select "**Call log**".

Select the desired contact from the list offered.



It is always possible to make a call directly from the telephone; park the vehicle first as a safety measure.

## Managing contacts / entries



Press on **Telephone** to display the primary page.



Select "**Contacts**".



Select "**View**".



Select "**Create**" to add a new contact, observing the "international format".

Or



"**Modify**" to edit the selected contact.

Or



"**Delete**" to delete the selected contact.

Or



"**Delete all**" to delete all information for the selected contact.



Select "**By name**" to view the list of contacts.

## Frequently asked questions

The following table groups together the answers to the most frequently asked questions concerning your audio system.

### Navigation

QUESTION	ANSWER	SOLUTION
The route calculation is not successful.	The route settings may conflict with the current location (exclusion of toll roads on a toll motorway).	Check the route settings in the "Navigation" menu.
The POIs do not appear.	The POIs have not been selected.	Select the POIs in the list of POIs.
The Risk areas audible warning does not work.	The audible warning is not active.	Activate audible warnings in the "Navigation" menu.
The system does not suggest a detour around an incident on the route.	The guidance criteria do not take account of TMC messages.	Select the "Information" function in the list of route settings.
I receive a Risk areas alert which is not on my route.	Other than guidance, the system announces all Risk areas positioned in a cone located in front of the vehicle. It may provide an alert for Risk areas located on nearby or parallel roads.	Zoom in on the map to view the exact position of the Risk areas. Select "On the route" to no longer receive alerts other than navigation instructions or to reduce the time for the announcement.

QUESTION	ANSWER	SOLUTION
Certain traffic jams along the route are not indicated in real time.	On starting, it is several minutes before the system begins to receive the traffic information.	Wait until the traffic information is being received correctly (display of the traffic information icons on the map).
	The filters are too restrictive.	Modify the settings.
	In certain countries, only major routes (motorways...) are listed for the traffic information.	This phenomenon is normal. The system is dependent on the traffic information available.
The altitude is not displayed.	On starting, the initialisation of the GPS may take up to 3 minutes to receive more than 4 satellites correctly.	Wait until the system has started up completely so that there is GPS coverage by at least 4 satellites.
	Depending on the geographical environment (tunnel...) or the weather, the conditions of reception of the GPS signal may vary.	This phenomenon is normal. The system is dependent on the GPS signal reception conditions.

## Radio

QUESTION	ANSWER	SOLUTION
<p>The quality of reception of the radio station listened to gradually deteriorates or the stored stations do not function (no sound, 87.5 Mhz is displayed...).</p>	<p>The vehicle is too far from the transmitter used by the station listened to or there is no transmitter in the geographical area through which the vehicle is travelling.</p>	<p>Activate the "RDS" function by means of the short-cut menu to enable the system to check whether there is a more powerful transmitter in the geographical area.</p>
	<p>The environment (hills, buildings, tunnels, basement car parks...) block reception, including in RDS mode.</p>	<p>This phenomenon is normal and does not indicate a fault with the audio system.</p>
	<p>The aerial is absent or has been damaged (for example when going through a car wash or into an underground car park).</p>	<p>Have the aerial checked by a PEUGEOT dealer.</p>
<p>I cannot find some radio stations in the list of stations received.</p>	<p>The station is not received or its name has changed in the list.</p>	<p>Press and hold the "List" button at the steering mounted controls to update the list of stations received or press on the system update function: "Update list".</p>
	<p>Some radio stations send other information in place of their name (the title of the song for example). The system interprets this information as the name of the station.</p>	

## Media

QUESTION	ANSWER	SOLUTION
Playback of my USB memory stick starts only after a very long wait (around 2 to 3 minutes).	Some files supplied with the memory stick may greatly slow down access to reading the memory stick (multiplication by 10 of the catalogue time).	Delete the files supplied with the memory stick and limit the number of sub-folders in the file structure on the memory stick.
When I connect my iPhone as a telephone and to the USB port at the same time, I am unable to play the music files.	When the iPhone connects automatically as a telephone, it forces the streaming function. The streaming function takes the place of the USB function which is then not useable, there is a period without sound of the track being played with Apple® players.	Disconnect and reconnect to the USB port (the USB function takes priority over streaming).
The CD is ejected automatically or is not played by the player.	The CD is inserted upside down, is unplayable, does not contain any audio data or contains an audio format which the player cannot play.	Check that the CD is inserted in the player the right way up.
	The CD has been recorded in a format that is not compatible with the player (udf...).	Check the condition of the CD: the CD cannot be played if it is too badly damaged.
	The CD is protected by an anti-pirating protection system which is not recognised by the audio system.	Check the content in the case of a recorded CD: refer to the advice in the "AUDIO" section. The audio system's CD player does not play DVDs. Some recorded CDs will not be played by the audio system because they are not of adequate quality.
There is a long waiting period following the insertion of a CD or connection of a USB memory stick.	When a new medium is inserted, the system reads a certain amount of data (directory, title, artist, etc.). This may take from a few seconds to a few minutes.	This phenomenon is normal.

QUESTION	ANSWER	SOLUTION
The CD player sound is poor.	The CD used is scratched or of poor quality.	Insert good quality CDs and store them in suitable conditions.
	The audio equipment settings (bass, treble, ambiences) are unsuitable.	Set the treble or bass level to 0, without selecting an ambience.
Some characters in the media information are not displayed correctly while playing.	The audio system does not display some types of characters.	Use standard characters to name tracks and folders.
Playing of streaming files does not start.	The peripheral device connected does not support automatic play.	Start the playback from the device.
The names of tracks and the track length are not displayed on the screen when streaming audio.	The Bluetooth profile does not allow the transfer of this information.	

## Settings

QUESTION	ANSWER	SOLUTION
In changing the setting of treble and bass the equalizer setting is deselected.	The selection of an equalizer setting imposes the balance settings. Modifying one without the other is not possible.	Modify the balance or equalizer settings to obtain the desired musical ambience.
In changing the equalizer setting, treble and bass return to zero.		
When changing the balance settings, the distribution setting is deselected.	The selection of a distribution setting imposes the balance settings. Modifying one without the other is not possible.	Modify the balance or distribution settings to obtain the desired musical ambience.
When changing an distribution setting, the balance setting is deselected.		
When the "All passengers" mode is selected, the distribution is not as I would like.	The choice of an "All passengers" distribution setting can be programmed.	Modify the distribution setting using the slider on the touch screen.



QUESTION	ANSWER	SOLUTION
There is a difference in sound quality between the different audio sources.	For optimum sound quality, the audio settings for Loudness, Ambience, Treble, Bass, Volume can be adapted to the different sound sources, which may result in audible differences when changing source.	Check that the audio settings (Loudness, Ambience, Treble, Bass, Volume) are adapted to the sources listened to. Adjust Balance, Treble and Bass to the middle position, select the "None" musical ambience and set the loudness correction to the "Active" position in CD mode or to the "Inactive" position in radio mode.
With the engine off, the system switches off after a few minutes of use.	When the engine is switched off, the system's operating time depends on the state of charge of the battery. The switch-off is normal: the system switches to economy mode and switches off to prevent discharging of the vehicle's battery.	Start the vehicle's engine to increase the battery charge.

## Telephone

QUESTION	ANSWER	SOLUTION
I cannot connect my Bluetooth telephone.	The telephone's Bluetooth function may be switched off or the telephone may not be visible.	Check that your telephone's Bluetooth function is switched on. Check in the telephone settings that it is "visible to all".
	The Bluetooth telephone is not compatible with the system.	You can check the compatibility of your telephone at <a href="http://www.peugeot.co.uk">www.peugeot.co.uk</a> (services).
The volume of the telephone connected in Bluetooth mode is inaudible.	The volume depends both on the system and on the telephone.	Increase the volume of the audio system, to maximum if required, and increase the volume of the telephone if necessary.
	The ambient noise level has an influence on the quality of telephone communication.	Reduce the ambient noise level (close the windows, reduce the booster fan speed, slow down...).
Some contacts are duplicated in the list.	The options for synchronizing contacts are synchronizing the contacts on the SIM card, the contacts on the telephone, or both. When both synchronizations are selected, some contacts may be duplicated.	Select "Display SIM card contacts" or "Display telephone contacts".
Contacts are not shown in alphabetical order.	Some telephones offer display options. Depending on the settings chosen, contacts can be transferred in a specific order.	Modify the display setting in the telephone directory.
The system does not receive SMS text messages.	The Bluetooth mode does not permit sending SMS text messages to the system.	



MM-BTEL  
SMEG+ IV2



**COFETEL : RCPMASM15-1111**

La operación de este equipo está sujeta a las siguientes dos condiciones: (1) es posible que este equipo o dispositivo no cause interferencia perjudicial y (2) este equipo o dispositivo debe aceptar cualquier interferencia, incluyendo la que pueda causar su operación no deseada.  
The operation of this equipment is subject to the following two conditions: (1) it is possible that this equipment or device may not cause harmful interference, and (2) the equipment or device must accept any interference, including interference that may cause undesired operation.



Class A Equipment (Industrial, Broadcasting & Communication Equipment).  
이 기기는 업무용(산업) 전자파 적합기기로서 판매자 또는 사용자는 이 점을 주의하시기 바라며, 가전과의 지역에서 사용하는 것을 목적으로 합니다.

MSIP-CMM-RX2-SMEGIV2

סמך אישור אילנותי של שידור התקשורת הוא 51-52173

אנאף להחליף את האנטנה הסדורית של הכשיר, ולא לעשות בו כל שינוי טכני אחר



INDOTEL identification for Dominican republic

CONATEL : 2015-06-I-0000190

Aprobado CNC C-14786

INCM: 16EBP15

TRC/SS/2015/258



005-101030  
AD15-0101005



41554/SDPPI/2015  
5142



Agréé par l'ARPT.  
Référence d'agrément :  
721/IR/AGR/PC/ARPT/2015



Este equipamento opera em caráter secundário, isto é, não tem direito à proteção contra interferência prejudicial, mesmo de estações do mesmo tipo e não pode causar interferência a sistemas operando em caráter primário.

PD 2795



# Compatibility of fuels

## Fuel used for petrol engines

The petrol engines are compatible with bio-fuels that conform to current and future European standards and can be obtained from filling stations.

**E5** Petrol that meets the EN228 standard, mixed with a bio-fuel meeting the EN15376 standard.

**E10**

**i** The only petrol additives authorised for use are those that meet the B715001 standard.

## Fuel used for Diesel engines

The Diesel engines are compatible with biofuels that conform to current and future European standards and can be obtained from filling stations.

**B7** Diesel fuel that meets standard EN590 mixed with a biofuel that meets standard EN14214 (possibly containing up to 7% Fatty Acid Methyl Ester).

**E5**

**E10**

**B7**

**B10**

**XTL**

**B20**

**B30**

**B10** Diesel fuel that meets standard EN16734 mixed with a biofuel that meets standard EN14214 (possibly containing up to 10% Fatty Acid Methyl Ester).

**XTL** Paraffinic Diesel fuel that meets standard EN15940 mixed with a biofuel that meets standard EN14214 (possibly containing up to 7% Fatty Acid Methyl Ester).

**B20** The use of B20 or B30 fuel meeting standard EN16709 is possible in your Diesel engine. However, this use, even occasional, requires strict application of the special servicing conditions referred to as "Arduous conditions".

**B30**

For more information, contact a dealer of the brand or a qualified workshop.

**!** The use of any other type of (bio) fuel (vegetable or animal oils, pure or diluted, domestic fuel...) is strictly prohibited (risk of damage to the engine and fuel system).

**i** The only Diesel additives authorised for use are those that meet the B715000 standard.

## Diesel fuel at low temperature

In temperatures below 0°C (+32°F), the formation of paraffins in the summer diesel fuels may result in abnormal operation of the fuel supply system. To avoid this, the use of winter diesel fuels is recommended, keeping the tank topped up to more than 50% of its capacity.

If in spite of this you experience difficulties starting the engine in temperatures below -15°C (+5°F), simply leave the vehicle in a garage or a heated workshop for a while.

## **i** Travelling abroad

**Certain fuels could damage the engine of your vehicle. In certain countries, the use of a particular fuel may be required (specific octane rating, specific sales name...) to ensure correct operation of the engine.**

For any additional information, contact your dealer.



16CAR.A040